

Model-Based Calibration Toolbox™

Model Browser User's Guide

R2013a

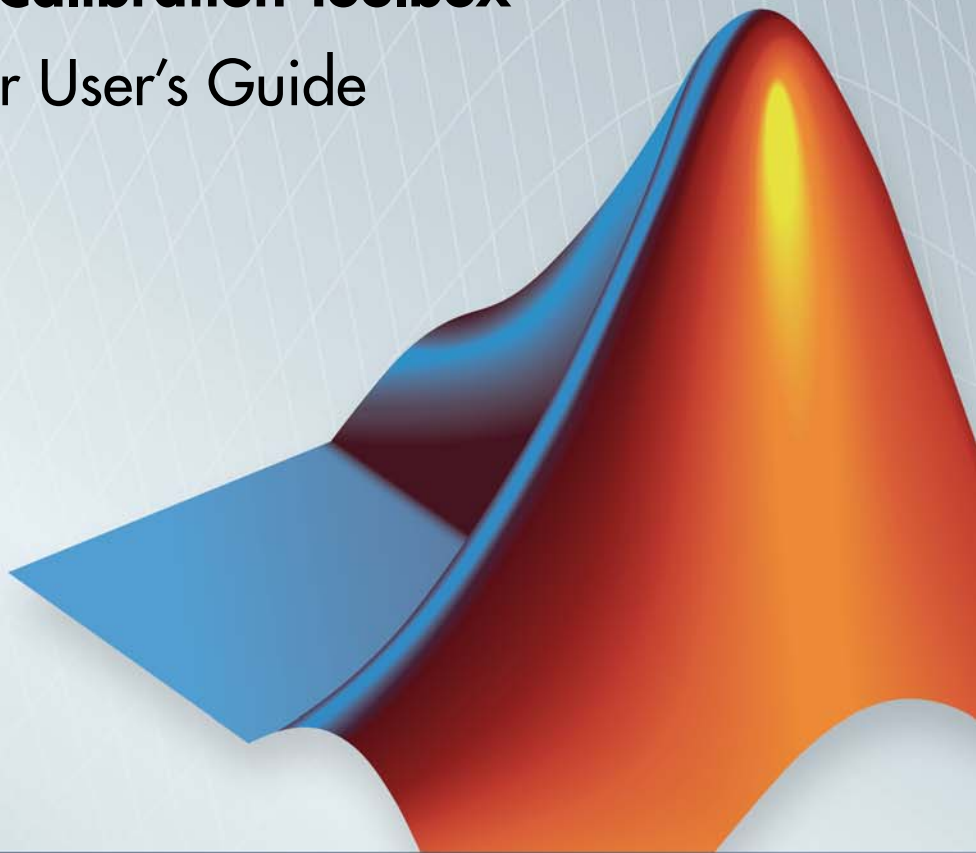

MATLAB® & SIMULINK®



How to Contact MathWorks



www.mathworks.com Web
comp.soft-sys.matlab Newsgroup
www.mathworks.com/contact_TS.html Technical Support



suggest@mathworks.com Product enhancement suggestions
bugs@mathworks.com Bug reports
doc@mathworks.com Documentation error reports
service@mathworks.com Order status, license renewals, passcodes
info@mathworks.com Sales, pricing, and general information



508-647-7000 (Phone)



508-647-7001 (Fax)



The MathWorks, Inc.
3 Apple Hill Drive
Natick, MA 01760-2098

For contact information about worldwide offices, see the MathWorks Web site.

Model-Based Calibration Toolbox™ Model Browser User's Guide

© COPYRIGHT 2001–2013 by The MathWorks, Inc.

The software described in this document is furnished under a license agreement. The software may be used or copied only under the terms of the license agreement. No part of this manual may be photocopied or reproduced in any form without prior written consent from The MathWorks, Inc.

FEDERAL ACQUISITION: This provision applies to all acquisitions of the Program and Documentation by, for, or through the federal government of the United States. By accepting delivery of the Program or Documentation, the government hereby agrees that this software or documentation qualifies as commercial computer software or commercial computer software documentation as such terms are used or defined in FAR 12.212, DFARS Part 227.72, and DFARS 252.227-7014. Accordingly, the terms and conditions of this Agreement and only those rights specified in this Agreement, shall pertain to and govern the use, modification, reproduction, release, performance, display, and disclosure of the Program and Documentation by the federal government (or other entity acquiring for or through the federal government) and shall supersede any conflicting contractual terms or conditions. If this License fails to meet the government's needs or is inconsistent in any respect with federal procurement law, the government agrees to return the Program and Documentation, unused, to The MathWorks, Inc.

Trademarks

MATLAB and Simulink are registered trademarks of The MathWorks, Inc. See www.mathworks.com/trademarks for a list of additional trademarks. Other product or brand names may be trademarks or registered trademarks of their respective holders.

Patents

MathWorks products are protected by one or more U.S. patents. Please see www.mathworks.com/patents for more information.

Revision History

December 2001	Online only	New for Version 1.0 (Release 12.1)
August 2002	Online only	Revised for Version 1.1 (Release 13)
May 2003	Online only	Revised for Version 2.0 (Release 13+)
June 2004	Online only	Revised for Version 2.1 (Release 14)
June 2004	Online only	Revised for Version 2.1.1 (Release 14+)
November 2005	Online only	Revised for Version 3.0 (Release 14SP3+)
September 2006	Online only	Version 3.1 (Release 2006b)
March 2007	Online only	Version 3.2 (Release 2007a)
September 2007	Online only	Revised for Version 3.3 (Release 2007b)
March 2008	Online only	Revised for Version 3.4 (Release 2008a)
October 2008	Online only	Revised for Version 3.4.1 (Release 2008a+)
October 2008	Online only	Revised for Version 3.5 (Release 2008b)
March 2009	Online only	Revised for Version 3.6 (Release 2009a)
September 2009	Online only	Revised for Version 3.7 (Release 2009b)
March 2010	Online only	Revised for Version 4.0 (Release 2010a)
September 2010	Online only	Revised for Version 4.1 (Release 2010b)
April 2011	Online only	Revised for Version 4.2 (Release 2011a)
September 2011	Online only	Revised for Version 4.3 (Release 2011b)
March 2012	Online only	Revised for Version 4.4 (Release 2012a)
September 2012	Online only	Revised for Version 4.5 (Release 2012b)
March 2013	Online only	Revised for Version 4.6 (Release 2013a)

Workflows For Modeling

1

What Is the Model Browser?	1-2
Set Up a One-Stage Model	1-3
Set Up a Two-Stage Model	1-5
Set Up a Point-by-Point Model	1-7
Point-by-Point Modeling Process	1-7
Use Cases for Point-by-Point Models	1-9
Analyzing Point-by-Point Models	1-10
Exporting Point-by-Point Models to CAGE	1-11
Create Alternative Models to Compare	1-14

Projects and Test Plans

2

Work with Model Browser Projects	2-2
Open a New Project	2-2
View All Project Models	2-3
View and Add Data Sets	2-3
View and Add Test Plans	2-5
Add Notes	2-7
Use Project Tools	2-7
Use Project Menus	2-8
Create Test Plans	2-11
Creating a New Test Plan	2-11
Creating New Test Plan Templates	2-12

Use Test Plans to Set Up Designs, Data, and Models ..	2-15
Working With Test Plans	2-15
Setting Up Model Inputs	2-17
Setting Up Local, Global and Response Models	2-18
Designing Experiments	2-19
Selecting Data	2-21
Choosing Summary Statistics	2-21
Creating Boundary Models	2-22
Saving the Current Test Plan as a Template	2-22
Test Plan Tools	2-22
Navigate the Model Tree	2-26
Navigating the Model Tree	2-26
Understanding Tree Structure	2-27
Icons: Curves, Worlds, and Houses	2-28
Icons: Blue Backgrounds and Purple Worlds	2-29

Designs

3

The Design Editor	3-2
Introducing the Design Editor	3-2
Opening the Design Editor	3-2
Design Styles	3-4
Design Editor Displays	3-5
Design Editor Toolbar and Menus	3-9
Creating a Classical Design	3-16
Creating a Space-Filling Design	3-19
Introducing Space-Filling Designs	3-19
Setting Up a Space-Filling Design	3-20
Halton Sequence	3-21
Sobol Sequence	3-22
Latin Hypercube Sampling	3-23
Lattice	3-24
Stratified Latin Hypercube	3-25
Augmenting Space-Filling Designs	3-26

Creating an Optimal Design	3-31
Introducing Optimal Designs	3-31
Optimal Design: Initial Design Tab	3-33
Optimal Design: Candidate Set Tab	3-35
Optimal Design: Algorithm Tab	3-38
Averaging Optimality Across Multiple Models	3-40
Adding and Editing Design Points	3-42
Adding Design Points	3-42
Editing Design Points	3-44
Merging Designs	3-45
Fixing, Deleting, and Sorting Design Points	3-47
Exporting and Importing Designs	3-50
Applying Constraints	3-51
How to Apply Constraints	3-51
Constraint Types	3-54
Importing Constraints	3-60
Prediction Error Variance Viewer	3-63
Introducing the Prediction Error Variance Viewer	3-63
Display Options	3-65
Prediction Error Variance	3-66
Prediction Error Variance for Two-Stage Models	3-68
Design Evaluation Tool	3-71
Introducing the Design Evaluation Tool	3-71
Table Options	3-73
Design Matrix	3-73
Full FX Matrix	3-74
Model Terms	3-74
Z2 Matrix	3-74
Alias Matrix	3-74
Z2.1 Matrix	3-75
Regression Matrix	3-75
Coefficient Information	3-75
Standard Error	3-77
Hat Matrix	3-78

X'X 	3-78
Raw Residual Statistic	3-79
Degrees of Freedom Table	3-79
Design Evaluation Graphical Displays	3-80
Export of Design Evaluation Information	3-81

Data

4

Using Data	4-2
The Data Editor	4-5
Introducing the Data Editor	4-5
Data Editor Views	4-7
Data Editor Toolbar and Menus	4-14
Data Loading and Merging	4-18
Introducing Data Loading	4-18
Loading Data from File	4-18
Loading Data from the Workspace	4-20
Tailor-Made Excel Sheets	4-22
Creating Variables	4-24
How to Create Variables	4-24
New Variables	4-24
Creating Filters	4-27
How to Create Filters	4-27
Test Filters and Test Notes	4-28
Filter Editor	4-28
Storage	4-30
Test Groupings	4-34
Data Selection Wizard	4-37
Opening the Data Selection Wizard	4-37

Step 1: Select Data Set	4-37
Step 2: Select Input Signals	4-38
Step 3: Select Response Models	4-40
Step 4: Set Tolerances	4-41
Matching Data to Designs	4-44
Introducing the Cluster Plot View	4-44
How to Use the Cluster Plot View	4-46
The Tolerance Editor	4-49
What Will Happen to My Data and Design?	4-50
Data Loading Application Programming Interface	4-52

Setting Up Models

5

What Models Are Available?	5-2
Local Model Setup	5-4
Introducing Local Model Setup	5-4
Local Model Class: Polynomials and Polynomial Splines ..	5-5
Local Model Class: Truncated Power Series	5-9
Local Model Class: Free Knot Spline	5-11
Local Model Class: Growth Models	5-12
Local Model Class: Linear Models	5-19
Local Model Class: Average Fit	5-20
Local Model Class: Multiple Models	5-22
Local Model Class: User-Defined Models	5-26
Local Model Class: Transient Models	5-35
Covariance Modeling	5-42
Correlation Models	5-44
Transforms	5-44
Boundary Model Setup	5-46
About Boundary Models	5-46
Creating a New Boundary Model	5-48
Setting Up Local, Global and Response Boundary Models	5-49
Plotting Boundary Models	5-55

Combining Best Boundary Models	5-58
Editing Boundary Model Fit Options	5-61
Saving and Exporting Boundary Models	5-65
Global Model Setup	5-66
Introducing Global Model Setup	5-66
Global Linear Models: Polynomials and Hybrid Splines ..	5-66
Global Model Class: Radial Basis Function	5-73
Global Model Class: Hybrid RBF	5-78
Global Model Class: Interpolating RBF	5-79
Global Model Class: Multiple Linear Models	5-80
Global Model Class: Free Knot Spline	5-82
Global Model Class: Neural Network	5-84
Global Model Class: User-Defined and Transient Models	5-86
New Response Models and Datum Models	5-87
Adding New Response Models	5-87
Datum Models	5-88
Build Alternative Models to Compare	5-90
Build a Selection of Models	5-90
New Template	5-91
User-Defined Template	5-91
Polynomial Template	5-92
RBF Template	5-92
Hybrid RBF Template	5-93
Free Knot Spline Template	5-93
Model Browser Template	5-94
Parallel Model Building	5-95

Selecting Models

6

Examine Local Models	6-2
What Is Local Level?	6-2
Using Local Model Plots	6-5
Viewing Local Model Statistics	6-8

Using the RMSE Explorer with Local Models	6-12
Removing Outliers and Updating Fits	6-13
Local Level Tools	6-18
Calculating Two-Stage Models and Response Features ...	6-24
Examine Global Models	6-26
What Is Global Level?	6-26
Global Special Plots	6-28
Global Scatter Plots	6-29
Removed Data Pane	6-31
Models List	6-32
Global Level: Toolbar	6-33
Global Level: Model-Specific Tools	6-34
Global Level: Menus	6-37
Compare and Select Best Models	6-42
Comparing Models	6-42
Select a Best Model	6-44
Plots and Statistics for Comparing Models	6-44
Model Selection Guide	6-64
Determining the Best Fit	6-64
Overfitting and Underfitting	6-64
RMSE	6-65
Other Statistics	6-66
Validation	6-67
Trends	6-68
Where to Find Statistics for Comparing Models	6-68
Summary Statistics	6-69
Using Information Criteria to Compare Models	6-71
References	6-74
Calculate and Compare MLE	6-75
Calculating MLE	6-75
MLE Settings	6-77
Examine Two-Stage Response Model	6-79
Evaluate Model Fit	6-82
About the Model Evaluation Window	6-82
Using Validation Data	6-84

Stepwise Regression	6-87
What Is Stepwise?	6-87
Automatic Stepwise	6-87
Using the Stepwise Regression Window	6-88
Stepwise in the Model Building Process	6-94
PRESS statistic	6-97
Box-Cox Transformation	6-100
Two-Stage Models for Engines	6-104
Overview of the Mathematics of Two-Stage Models	6-104
Local Models	6-106
Local Covariance Modeling	6-106
Response Features	6-108
Global Models	6-108
Two-Stage Models	6-109
Global Model Selection	6-110
Initial Values for Covariances	6-111
Quasi-Newton Algorithm	6-111
Expectation Maximization Algorithm	6-111
References	6-112
Linear Regression	6-113
Toolbox Terms and Statistics Definitions	6-114
Export Models to MATLAB, Simulink, and CAGE	6-117
Export Models to Simulink	6-118
Export Models for Simulation	6-118
Use Statistical Models for Plant Modeling and Optimization	6-120
Use Statistical Models for Hardware-in-the-Loop Testing	6-122
Export Models to the Workspace	6-123
Export Models to MATLAB	6-123
Work with Models in the Workspace	6-125
Evaluate Response Models and PEV	6-125
Evaluate Confidence Intervals	6-126
Evaluate Boundary Models in the Workspace	6-127

Radial Basis Functions for Model Building	7-2
About Radial Basis Functions	7-2
Types of Radial Basis Functions	7-3
Fitting Routines	7-11
Center Selection Algorithms	7-12
Lambda Selection Algorithms	7-15
Width Selection Algorithms	7-19
Prune Functionality	7-25
Statistics	7-27
Hybrid Radial Basis Functions	7-31
Tips for Modeling with Radial Basis Functions	7-33

Workflows For Modeling

The following sections introduce the Model Browser part of the Model-Based Calibration Toolbox™ product.

- “What Is the Model Browser?” on page 1-2
- “Set Up a One-Stage Model” on page 1-3
- “Set Up a Two-Stage Model” on page 1-5
- “Set Up a Point-by-Point Model” on page 1-7
- “Create Alternative Models to Compare” on page 1-14

What Is the Model Browser?

The Model-Based Calibration Toolbox product contains tools for design of experiment, statistical modeling, and calibration of complex systems. See . The toolbox has two main user interfaces:

- Model Browser for design of experiment and statistical modeling
- CAGE Browser for analytical calibration

The Model Browser is a flexible, powerful, intuitive graphical interface for building and evaluating experimental designs and statistical models:

- Design of experiment tools can drastically reduce expensive data collection time.
- You can create and evaluate optimal, space filling, and classical designs, and constraints can be designed or imported.
- Hierarchical statistical models can capture the nature of variability inherent in engine data, accounting for variation both within and between tests.
- The Model Browser has powerful, flexible tools for building, comparing, and evaluating statistical models and experimental designs.
- There is an extensive library of prebuilt model types and the capability to build user-defined models.
- You can export models to CAGE or to MATLAB®, or Simulink® software.

Starting the Model Browser

To start the application, type

```
mbcmodel
```

at the MATLAB command prompt.

Set Up a One-Stage Model

The following steps are necessary to set up a one-stage model:

- 1** From the project node, create a new one-stage test plan. See “Creating a New Test Plan” on page 2-11. The view changes to select the new node in the model tree and show you the test plan level.
- 2** Set up the inputs and model type by double-clicking the Inputs block and the Model block in the test plan diagram. See “Setting Up Model Inputs” on page 2-17 and “Global Model Setup” on page 5-66.
- 3** At this point, you might want to design an experiment. See “The Design Editor” on page 3-2.
- 4** From the test plan node, load a new data set to use. Choose **TestPlan > Select Data** which opens the Data Wizard. Click **Load new data set** and the Data Import Wizard appears. See “Loading Data from File” on page 4-18. Use the Data Wizard to match up data signals with model inputs and outputs.
- 5** Dismissing the Data Wizard opens the Data Editor, where you can select data for modeling and match data to designs. See “The Data Editor” on page 4-5.

On closing the Data Editor the model fit is calculated and the new model node appears in the model tree.

- 6** View the model fit.

Functionality available for viewing and refining the model fit is described in “Examine Global Models” on page 6-26 and “Compare and Select Best Models” on page 6-42.

- 7** You can create a boundary model at the test plan node. A boundary model describing the limits of the operating envelope can be useful when you are creating and evaluating designs, optimization results and global models. It can be useful to create the boundary model before viewing global models, so you can see the model areas inside the boundary on plots. See “Boundary Model Setup” on page 5-46.

Once you have built a single model, you should create more models for comparison, to search for the best fit. You can follow the guidelines in “Create Alternative Models to Compare” on page 1-14.

Set Up a Two-Stage Model

The following steps are necessary to set up a two-stage model:

- 1** From the project node, create a new two-stage test plan. See “Creating a New Test Plan” on page 2-11.
- 2** From the test plan node, set up the inputs and models at the local and global stages. See “Setting Up Model Inputs” on page 2-17, “Local Model Setup” on page 5-4 and “Global Model Setup” on page 5-66.
- 3** At this point, you might want to design an experiment. See “The Design Editor” on page 3-2.
- 4** From the test plan node, load the data set you want to use. Select **TestPlan > Select Data**. See “Loading Data from File” on page 4-18.

This opens the Data Wizard, where you can load a data set, match data signals to model variables and then set up the response model.

- 5** On completing the Data Wizard, the Data Editor opens. Here you can select data for modeling and match data to designs. See “The Data Editor” on page 4-5. Close the Data Editor and click **Yes** to accept the data for modeling.

Note On closing the Data Editor, the local and global models are calculated.

- 6** At the local node, you can view the fit of the local models to each test, and you can also view the global models at the response feature nodes.
- 7** You can create a boundary model at the test plan node. Boundary models describe the limits of the operating envelope and can be useful when you are creating and evaluating designs, optimization results and global models. It can be useful to create the boundary model before viewing global models, so you can see the model areas inside the boundary on plots. See “Boundary Model Setup” on page 5-46.
- 8** The two-stage model is not calculated until you use the **Select** button (from the local node, in the **Response Features** pane) and choose a model as best (even if it is the only one so far), *unless* you go straight to MLE. See below.

See “Compare and Select Best Models” on page 6-42.

Note At this point, the two-stage model is calculated, and the icon changes at the local node to reflect this. See “Icons: Curves, Worlds, and Houses” on page 2-28.

- 9 You are prompted to calculate the maximum likelihood estimate (MLE) at this point. You can do this now, or later by selecting **Model > Calculate MLE**. See “Calculate and Compare MLE” on page 6-75 for a detailed explanation.

Note If there are exactly enough response features for the model, you can go straight to MLE calculation without going through the **Select** process. The **MLE toolbar** button and the **Model > Calculate MLE** menu item are both active in this case. If you add new response features, you cannot calculate MLE until you go through model selection to choose the response features to use.

See “Two-Stage Models for Engines” on page 6-104 for a detailed explanation of two-stage models.

Double-click the Model blocks of the block diagram or select the **TestPlan > Set Up Model** menu item. The toolbox supports a wide range of models.

For model descriptions, see “Global Model Setup” on page 5-66 and “Local Model Setup” on page 5-4.

Once you have built a single model, you should create more models for comparison, to search for the best fit. You can follow the guidelines in the next section, “Create Alternative Models to Compare” on page 1-14.

Set Up a Point-by-Point Model

In this section...

“Point-by-Point Modeling Process” on page 1-7

“Use Cases for Point-by-Point Models” on page 1-9

“Analyzing Point-by-Point Models” on page 1-10

“Exporting Point-by-Point Models to CAGE” on page 1-11

Point-by-Point Modeling Process

Use the following process to set up a point-by-point model:

- 1** Create a new test plan.
 - a** From the project node, click **New** to create a new point-by-point test plan.
 - b** Select the **Point-by-Point** template and click **OK**.

This template allows you to create point-by-point test plans with local models at each engine operating point, which is useful when testing is done at fixed operating point settings. See “Use Cases for Point-by-Point Models” on page 1-9.

The new test plan sets up two local and two global inputs, and the local model type is set to Multiple Models. This local model type allows you to choose a variety of models to try for each test.
- 2** Set up the inputs by double-clicking the Inputs blocks in the test plan diagram. See “Setting Up Model Inputs” on page 2-17.
- 3** To design a global experiment to specify operating points where you want to collect tests, right-click the Operating Point Selector block and select **Design Experiment**. There is no global model for point-by-point models, so the test plan diagram shows the Operating Point Selector block instead of the Global Model block for two-stage models. Point-by-point models select which local model to evaluate by matching the global inputs with the set of global operating points in the test plan.
- 4** Set up the multiple model types. By default, point-by-point test plan templates include four model types: a quadratic, a cubic, an RBF and a

hybrid RBF. If you want to change or add to these, double-click the Local Model block in the test plan diagram, and then click **Edit** in the Local Model Setup dialog box. The toolbox fits all the models you choose and then indicates the best one chosen for each test in your data. For example, for some tests a radial basis function may fit best, while for others a quadratic would be acceptable. You can use any model available as one-stage models (including radial basis functions (RBF) and hybrid RBF).

The **Automatic input ranges** check box defaults to selected. This selection uses the range of the data for each test, instead of a single range for all. You can choose any of the summary statistics as the selection criteria for deciding which model fits best to each test.

For more information see “Local Model Class: Multiple Models” on page 5-22.

- 5** Select data to use. From the test plan node, select **TestPlan > Select Data** which opens the Data Selection Wizard. Load a data file (see “Loading Data from File” on page 4-18) then match up data signals with model inputs and outputs (see “Step 2: Select Input Signals” on page 4-38).

You can click **Finish** on the Input Names pane: there is no need to build response models before building boundary models. Alternatively, you can continue with the Data Selection Wizard to specify any responses you want to model.

- 6** Create boundary models in the Boundary Editor. Select **TestPlan > Boundary Models**. To build point-by-point boundary models for each operating point, create a local boundary model, and select **Point-by-Point** for the **Global evaluation** type. See “Creating a New Boundary Model” on page 5-48.
- 7** If you have not already built response models, from the test plan node, double-click the Response block to choose a response and fit models.

The view switches to the new **Multiple Models** node in the model tree. View and edit the local model fit for each operating point.

Tools specific to local multiple models are described in “Analyzing Point-by-Point Models” on page 1-10.

For details about other functionality available for viewing and refining the model fit, see “Examine Local Models” on page 6-2 and “Compare and Select Best Models” on page 6-42.

- 8 Export your point-by-point models to CAGE for optimized calibration. From the test plan node, select **Test Plan > Export Point-by-Point Models**.

If CAGE is open, you can also use the dialog box options to automatically create the following objects from your point-by-point models:

- Data set
- Tradeoff
- Optimization

See “Exporting Point-by-Point Models to CAGE” on page 1-11.

Note This export option is only available if you have exactly two global inputs; otherwise you can import your point-by-point models into CAGE using the CAGE Import Tool.

Use Cases for Point-by-Point Models

The point-by-point test plan template and the local multiple models type provides a convenient mechanism to model a number of tests at different operating points using the same set of models. Using the test plan has several advantages, including:

- You can divide the data into tests and model it within a single test plan rather than having a separate one-stage test plan for each operating point. The toolbox does not construct two-stage models or response feature models because it is impossible to choose response features that apply to all tests, when there are different model types for different tests. You must have at least one global variable (e.g. speed, injection timing, load) and you cannot use covariance modeling.
- The local multiple models type provides a smooth interface with the CAGE browser part of Model-Based Calibration toolbox software. To make use of this, you must specify two global inputs (often speed and load) which can

form the axes of tradeoff tables. This useful application for multiple models allows you to calibrate from local maps.

- You can also use point-by-point models in CAGE optimization, by creating an optimization from your models, or you can use the models in an existing optimization provided the global variable values are exactly the same as the global variables used for the local models in the Model Browser.
- You can export point-by-point models to file or directly into CAGE, and automatically create an optimization, a tradeoff, and a data set from your point-by-point models.

Analyzing Point-by-Point Models

In the local model view, you find controls and menu items specific to point-by-point models (using the `Multiple models` local model type).

- You can select **Model > Utilities > Select Local Model** to open the Model Selection window. All the alternative models are refitted at this stage (as only the best model is stored) so this refitting can take time. In the Model Selection window you can compare the fit of your local model types to the data, and select which of those model types to use for the selected test.

In the Model Selection and Model Evaluation window, you can view local boundaries on surface and cross-section plots. If you selected **Automatic input ranges** during model setup, plots for point-by-point models use the data ranges per test (unlike typical two-stage models).

- You can select **Model > Utilities > Add Local Model** to open the Model Setup dialog box. In this dialog box, you can add a model type. When you click **OK** the toolbox fits the new model type to all tests, and then selects it as best if it is better (by your selection criteria) than any of the alternatives for a test. A dialog box informs you which tests (if any) have a new best model.
- You can select **Model > Utilities > Summary Statistics** to open the Summary Statistics dialog box. In this dialog box, you can select statistics to display in the Model Selection window and in the **Diagnostic Statistics** Summary Table (in the local model view). See “Summary Statistics” on page 6-69. If you are using validation data, the validation RMSE appears in this Summary Table for the test, if there is validation data for the current test (global variables must match), for comparison with the model fit RMSE. See “Using Validation Data” on page 6-84.

- In the **Diagnostic Statistics** pane you can select **Model Selection** from the drop-down list. This pane displays the value of your selection criteria (e.g., AICc) for each model type, with the best model highlighted in red. You select criteria in the Local Model Setup dialog box when you create local multiple models.

Exporting Point-by-Point Models to CAGE

If you have exactly two global inputs, you can export point-by-point models from the Test Plan node in the Model Browser by selecting **TestPlan > Export Point-by-Point Models**.

- If the CAGE Browser is closed, the toolbox creates a point-by-point model tradeoff file for use with the CAGE import dialog box **Import Point-by-Point Model Tradeoff**. Choose a location and enter a file name in the dialog box.
- If the CAGE Browser is open, you see the **Export Point-by-Point Models** dialog box, as shown in the following figure.

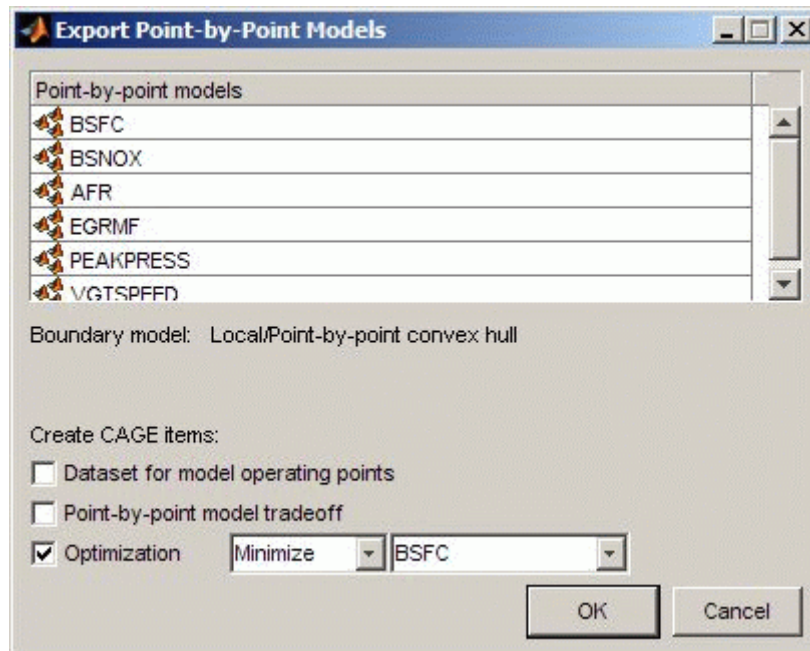

You can create the following items in CAGE (depending on your check box selections in the dialog box):

- Point-by-point models, for all responses in the test plan.

The toolbox creates a single CAGE model for each response and defines the models only at operating points corresponding to the global inputs—for example, at the values of speed and load where you performed tests.

The toolbox uses the response name for each CAGE model name, and replaces any existing CAGE model of that name. The model inputs are connected to variables matching the symbols. The set points are the same as the first row of the dataset, corresponding to the first operating point. You can view the model surface in the Model View and the Surface Viewer.

- Local boundary models for each point-by-point model.

If you have created local boundary models (and selected them as best), the toolbox includes them in the export.

If you have not created local boundary models, the toolbox creates them automatically, and you see a notation of “(created)” after the text describing the boundary model. The toolbox builds a range boundary model in all local inputs for each test.

- Data set for model operating points (optional).

The dataset contains the midpoints of the local input ranges for all tests and the global operating points.

- A point-by-point model tradeoff (optional).

The toolbox creates a point-by-point model tradeoff in the same way as using the Import Point-by-Point Model Tradeoff dialog box. These tradeoff tables are initialized with the midpoints of the local input ranges.

- An optimization (optional).

The toolbox creates an `foptcon` optimization.

If you choose to create the optimization, use the drop-down menus to specify the response to be optimized and whether the objective should be minimized or maximized. The optimization includes the boundary model as a constraint and uses the same values as the dataset to specify a run per operating point. You can use the new optimization with Automated Tradeoff.

You can also import the point-by-point models directly into CAGE from the Model Browser using the CAGE Import Tool. If you have more than two global inputs you must use the Import Tool.

Create Alternative Models to Compare

Once you have fitted and examined a single model (either one- or two-stage), you will normally want to create more models to search for the best fit. You can:

- Create individual new models.
 - You can create new child nodes by clicking the **New** button from any modeling node. The Model Setup dialog box appears where you can change the type and settings. You can repeat this for multiple child nodes to create a selection of different model types fitted to the same data.
- Create a template to save a variety of model settings for reuse.
 - From any global or one-stage model with child nodes, select **Model > Make Template**. You can save the child node model types of your currently selected modeling node as a template. You can then use the Build Models dialog box to find your user-defined templates and quickly build all those model types again for any global model you choose (see below).
 - From any global model node (before calculating MLE), click **Build Models** in the toolbar. You can save a template containing whatever models you choose by selecting **New** and adding the model types you want.
- Use the **Build Models** function to create a selection of models at once. You can create templates, use predefined templates, and use models in the current project as a template. All the child node model types in the template you select are built as child nodes of the currently selected global model. See “Boundary Model Setup” on page 5-46.

Creating a template containing a list of all the models you want is a very efficient way to quickly build a selection of alternative model child nodes for many global models. Use these techniques to find models that fit well to the data for each of your global models.

We provide a detailed tutorial example to guide you through using these techniques to make a number of models to compare. See the modeling tutorial section “Create Multiple Models to Compare” in the Getting Started documentation. This tutorial section requires you to have completed the

previous steps in the Quick Start tutorial, so that you have an initial model as a starting point.

Note that you can click **New** from any modeling node to create new child nodes.

- For all global model nodes (one- and two-stage) a new child node appears that is a copy of the parent, and the Model Setup dialog box appears where you can change the type and settings.
- For the other two-stage modeling nodes (local and response models) you also get a new child node but the procedure is slightly different — see the tutorial example for details.

Once you have a variety of models to compare, you should use the diagnostic statistics and powerful visual aid plotting capabilities of the Model Browser to help you decide which models are best. For a description of the views and statistics available in each modeling view, see:

- “Compare and Select Best Models” on page 6-42
- “Evaluate Model Fit” on page 6-82
- “Examine Local Models” on page 6-2
- “Examine Global Models” on page 6-26
- “Examine Two-Stage Response Model” on page 6-79

For linear models, make use of the Stepwise functions (open the Stepwise window for existing models, and/or choose a **Stepwise** option during model setup) to refine your models and remove less useful model terms. Make sure you examine outliers but do not automatically remove them without good reason. Pay attention to the diagnostic statistics to help you find the best models. The following sections describe how to use Stepwise to make better models and how to understand the diagnostic statistics:

- “Model Selection Guide” on page 6-64 for guidelines.
- “Stepwise Regression” on page 6-87 for an introduction to Stepwise.
- “PRESS statistic” on page 6-97 — See this section for guidelines on what to look for in the statistics to indicate a good fit.

Projects and Test Plans

- “Work with Model Browser Projects” on page 2-2
- “Create Test Plans” on page 2-11
- “Use Test Plans to Set Up Designs, Data, and Models” on page 2-15
- “Navigate the Model Tree” on page 2-26

Work with Model Browser Projects

In this section...
“Open a New Project” on page 2-2
“View All Project Models” on page 2-3
“View and Add Data Sets” on page 2-3
“View and Add Test Plans” on page 2-5
“Add Notes” on page 2-7
“Use Project Tools” on page 2-7
“Use Project Menus” on page 2-8

Open a New Project

When you open the Model Browser part of the Model-Based Calibration Toolbox product, there is a single node, the project (named Untitled), in the model tree. This node is automatically selected. When you start a new project you are automatically at project level, as there are not yet any other nodes to select.

Note The node you select in the model tree determines what appears in the menus and panes of the rest of the Model Browser.

Select the project node in the model tree at any time to:

- Create new test plans
- View data sets in the project and add new data sets
- Add project notes

See to find information about using the Model Browser.

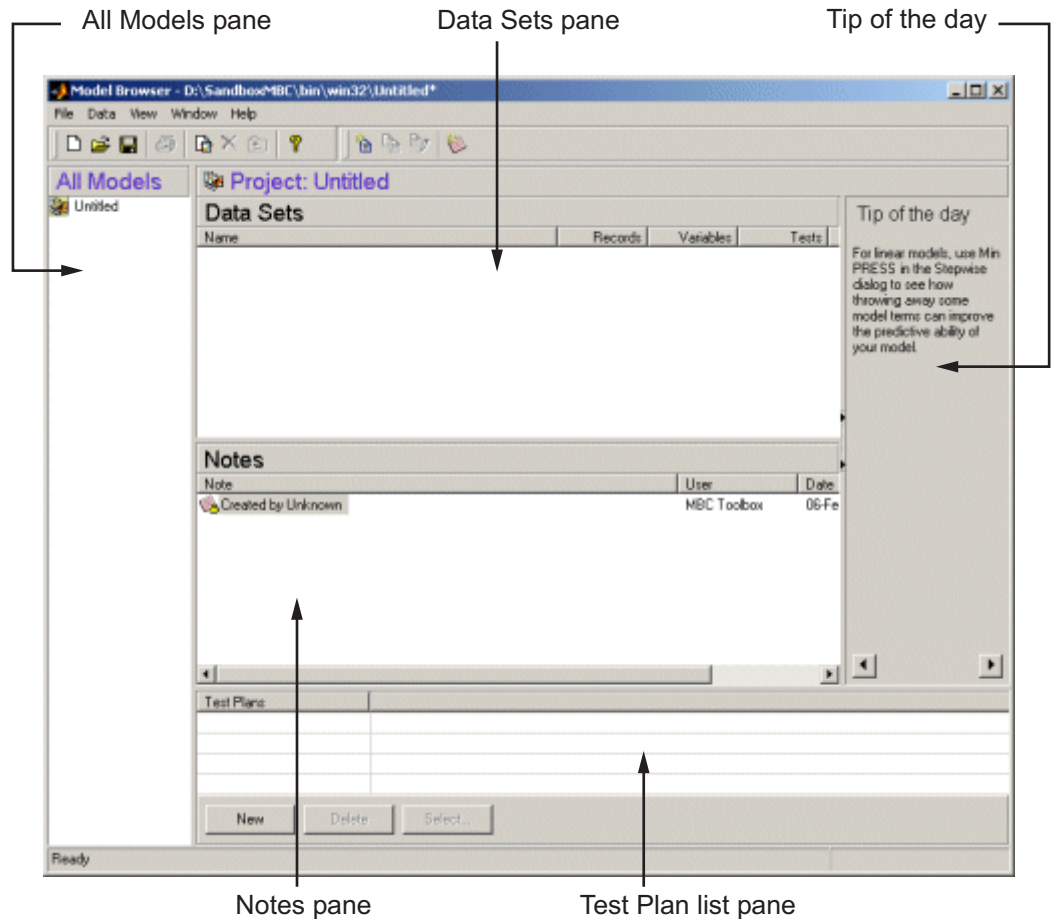

View All Project Models

The All Models Pane contains a hierarchical tree structure showing all the models created within the current project. See “Navigate the Model Tree” on page 2-26 for a detailed description of the information contained in this pane.

View and Add Data Sets

All data sets loaded in the current project are displayed in the **Data Sets** pane (whether in use for modeling or not).

To add a new data set to the project, select **Data > New Data**. See “Data Loading and Merging” on page 4-18.

For a data set already loaded in the project, you can select a data set by clicking it in the Data Sets pane and then:

- Rename it, by clicking again or pressing **F2** (as when selecting to rename in Windows Explorer), then editing the name.
- Delete it by pressing the **Delete** key.
- Open it by double-clicking. Double-clicking a data set opens the Data Editor; unless it is already associated with a test plan, see below. See “The Data Editor” on page 4-5.

Note All data sets loaded are visible at the project node and appear in the **Data Sets** pane. However, they are not necessarily used by any test plan child nodes of that project until you select them within a particular test plan. For example, with a data set loaded at the project node, when you switch to a new test plan node, the **Data Sets** pane at top right displays ‘No Data is selected’ until you use the Data Wizard to attach data to that test plan. See “Data Selection Wizard” on page 4-37.

The same data set can be used by many test plans within a project, although each individual test plan can only ever use one data set (and one validation data set).

When you have associated a data set with a test plan, a new data set icon (with a name specific to that test plan) appears here in the Data Sets pane. The same data set may be used by several test plans, at which you may have applied different filters, groupings or edits, and so each time you associate a data set with a new test plan a new icon appears here.

Note You cannot edit data sets that belong to a test plan at project level, you must edit them from the associated test plan.

View and Add Test Plans

You create new test plans from the **Test Plans** list pane by clicking the **New** button. See “Create Test Plans” on page 2-11.

This pane is the **Test Plans** list pane at startup but changes depending on the level in the model tree that is selected. The list box always displays all the child nodes of whichever node is currently selected in the tree in the **All Models** pane, and always contains three buttons: **New**, **Delete**, and **Select**.

Note Double-clicking any item within this pane changes the view directly to that node. (This is equivalent to selecting that node in the model tree.) You can also use the **Delete** and **Insert** keys to remove or add new test plans (select a test plan first).

- The **Test Plans** list becomes the **Response Models** list, the **Local Models** list, the **Response Features** list, and the **Models** list as you select the nodes at subsequent levels of the model tree. In each case this pane displays the immediate child nodes of the current node selected. You can use the buttons to delete selected nodes or create new nodes.
- The feature added by clicking **New** always corresponds to the list items. For example, clicking **New** when the pane shows a list of test plans adds a new test plan. Clicking **New** when the pane shows a list of response features opens the Response Features dialog box, as shown in the following example. The response features you can add are model-specific. This example shows the response features available for a polyspline model.

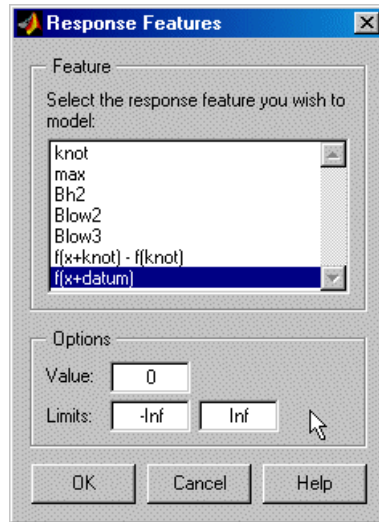

For example, if you choose $f(x + \text{datum})$ and enter 10 in the **Value** edit box, the new response feature tracks the datum +10. For a torque/spark polyspline model, the datum is MBT (maximum brake torque); so the new response feature is MBT + 10 degrees of spark angle. This allows you to create response features that have engineering interest.

The response features available depend on the model type. For more details on which response features are available, see each model type under “Local Model Setup” on page 5-4.

- You can use the **Select** button to select the best child node, but only when the child nodes are local models, response features, or submodels of response features. In each case clicking the **Select** button takes you to a selection window where you can compare the child nodes. See “Compare and Select Best Models” on page 6-42.

Tip of the Day

Hints about using the Model Browser appear here. You can scroll through more tips using the buttons at the bottom, and you can snap this pane closed or open by clicking the “snapper point” where the cursor changes if you roll the mouse over it.

Add Notes

The **Notes** pane contains a list box showing all previous notes on the current project. You use notes to record changes within a project, perhaps by different users, over time.

- You add new notes by clicking the **Add new note** button  in the toolbar, or by pressing the **Insert** key after selecting the **Notes** pane by clicking. Notes automatically have the user login name and the date.
- You edit notes (only the user that created them can edit them; user names must match) by select-clicking or by pressing **F2** when selected (as when selecting to rename in Windows Explorer). Edited notes have updated time and date fields.
- You remove notes by selecting them and pressing **Delete** (but only the same user that created them can delete them).
- Notes are automatically added to the project when it is modified (for example, the initial “Created by <username>” note). These notes (listed as user “info”) cannot be deleted or edited.

Use Project Tools

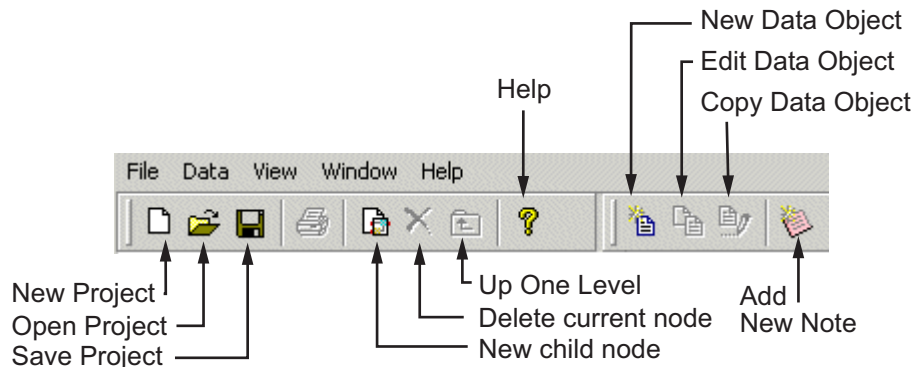

This is how the toolbar appears when you first start the toolbox. The last two Data buttons are grayed out; the **Edit data object** and **Copy data object** buttons are not enabled until a data set has been loaded.

- All the toolbar items are duplicated under the menus except New Note.

- For the **Project** buttons, see the File menu.
- For the **Data** buttons, see the Data menu.
- New Note adds a note to the **Notes** pane.
- The **New** and **Delete** node buttons are duplicated in the **File** menu. In both cases, their function depends on the node selected in the model tree. In every case, **New** generates a new child node of the one currently selected, and **Delete** removes the current node (and all its children).
- The **Up One Level** button moves the current selection (and hence all the views) one level up the model tree. For example, if a test plan node is selected, clicking this button moves one level up to the project node.

Two buttons, **Delete** and **Up One Level**, are grayed out at startup because the default selection in the model tree is the project node, so there are no levels above, and you cannot delete the project node (although you can replace it with a new one).

- The print icon is only enabled in views with plots, for example, the local node, response feature nodes, and response nodes *after* selection of a best two-stage models (response nodes are blank until then).
- The **Help** button opens the Help Browser and displays the appropriate help documentation for the current view in your Model Browser.

Use Project Menus

File Menu

Note The **File** menu remains constant in each Model Browser view. The **New child node** function always creates a new child node, and the **Delete current node** function always deletes the current node. These change according to which node in the model tree is currently selected.

- **New Project** opens a new project file. You are prompted to save or lose the current project.
- **Open Project** opens a file browser to select the project to open.

- **Save Project** and **Save Project As** save the project with all the models it contains as a .mat file.
- **New Test Plan** opens a dialog box with the choice of **One-Stage** or **Two-Stage** test plans, or you can browse for other test plans. The **New** (child node) menu option always creates a new child node of whichever node is selected in the model tree.

At startup, the project node is automatically selected, so the appropriate child node is a new test plan.

Note **File > New** changes depending on which node in the model tree is selected. In each case the option offers a new child node immediately below the one currently selected, that is, a **New Test Plan** (if a project node is selected), a **New Response Model** (from a test plan) or a **New Model** child node (from a one-stage response). For two-stage models you can add a **New Local Model** (from a response node), a **New Response Feature** (from a local node) and a **New Model** from a response feature node.

- **Export Models** brings up the Export Models dialog box. This allows you to export any models selected in the tree (along with their child nodes, in some cases) to the MATLAB workspace, to file for importing into CAGE, or to Simulink software. See “Export Models to MATLAB, Simulink, and CAGE” on page 6-117.
- **Delete “Untitled”** Like the **New** item in this menu, this option changes depending on which node in the model tree is selected. This menu item deletes whichever node is currently selected in the model tree (along with any child nodes), and the appropriate name appears here.
- **Clean Up Tree** From any modeling node where a best model has been selected (from the child nodes), you can use this to delete all other child nodes. Only the child nodes selected as best remain.
- **Preferences** brings up the MBC File Preferences dialog box, in which you can specify default locations for projects, data, models, and templates. You can also edit and save user information: name, company, department and contact details. This information is saved with each project level note, and you can use this to trace the history of a project.
- **Print** is only enabled in views with plots — not test plan or project level.

- **1,2,3,4:** A list of the four most recent project files, including their pathnames.
- **Close** Exits from the Model Browser part of the toolbox (CAGE and MATLAB are unaffected).

Data Menu

- **New Data** — Opens the Data Editor. See “The Data Editor” on page 4-5.
- **Copy Data** — Copies the selected data set.
- **Edit Data** — Opens the Data Editor to enable data editing.
- **Delete Data** — Deletes the selected data set.

View Menu

- **Tip of the Day** — Choose to display or hide the tips pane.
- **Note Information** — Opens a dialog box where you can decide which categories of information to display for each project note. You can specify user information for display with notes by using **File > Preferences**.

Window Menu

Depending on which toolbox windows are open, a list appears under this menu and whichever window is selected is brought to the front. The **Window** menu remains throughout the Model Browser.

Help Menu

The **Help** menu remains consistent throughout the Model Browser.

- **MBC Help** — Opens the Model-Based Calibration Toolbox Roadmap with links to the help tutorials and the indexed help pages.
- **Context Help** — Depending on what part of the Model Browser is currently active, **Context Help** links to different places in the Help files.
- **About MBC** — Displays version notes.

Create Test Plans

In this section...

“Creating a New Test Plan” on page 2-11

“Creating New Test Plan Templates” on page 2-12

Creating a New Test Plan

You need to select a test plan to construct models or designs.

To create a new test plan:

- Enter `mbcmode1` to open the Model Browser.

In the Model Browser, you create new test plans from the project level.

- Click **New** in the **Test Plans** pane.

You can see the **Test Plans** pane at startup and whenever you select the project node in the model tree.

Alternatively, make sure the project node is selected first, and then do one of the following:

- Click the **New Test Plan** icon () in the toolbar.
- Select **File > New Test Plan**.
- Press **Insert** immediately after clicking the tree.

These steps all open a dialog box with the choice of **One Stage**, **Two Stage**, or **Point-by-Point** test plans, or you can browse for other test plans. You can create new test plan templates so you can reuse the setup for one test plan with another set of data. See “Creating New Test Plan Templates” on page 2-12.

A new test plan node appears in the model tree. To view the new test plan:

Change to test plan level:

- Select the node  in the tree by clicking it.

Alternatively, double-click the new test plan in the **Test Plans** pane, as in Windows Explorer.

The Model Browser changes to test plan level, showing the block diagram representations of models in the main display, and the **Test Plans** pane changes to the **Response Models** pane (empty until models are set up).

For the next steps in model construction, see

- “Local Model Setup” on page 5-4
- “Boundary Model Setup” on page 5-46
- “Global Model Setup” on page 5-66
- “New Response Models and Datum Models” on page 5-87
- “Data Loading and Merging” on page 4-18
- “Model Selection”

Creating New Test Plan Templates

You build user-defined templates from existing test plans using the Make Template toolbar button  or **TestPlan > Make Template**.

The procedures for modeling engines for calibrations are usually repeated for a number of different engine programs. The test plan template facility allows you to reuse the setup for one test plan with another set of data. You can alter the loaded test plan settings without restriction.

A list of test plan templates is displayed when you build a new test plan. There are built-in templates for one- and two-stage models.

Test plan templates store the following information:

- Hierarchical model — Whether the model is one- or two-stage and the default models for each level.
- Designs — *If* they were saved with the template (check box in the Test Plan Template Setup dialog box)

The design for one type of engine might or might not be appropriate for a similar type of engine. You can redefine or modify the design using the Design Editor.

- All response models (for example, torque, exhaust temperature, emissions) — *If* they were saved with the template (check box in the Test Plan Template Setup dialog box)
- Numbers and names of input factors to models
- Model types (local and global)
- Summary Statistics for display (see “Summary Statistics” on page 6-69)
- No model child nodes are included, just the top level of the test plan (response models, and local and global models for two-stage models).

The response models are automatically built after you assign data to the test plan; see “Using Stored Templates” on page 2-13.

Saving a New Template

From the test plan node that you want to make into a template:

- Click the **Make Template** toolbar icon or choose **TestPlan > Make Template**.

The templates are stored in the directory specified in the **File > Preferences** dialog box.

The Test Plan Template Setup dialog box appears, in which you can change the name of the new template and choose whether to include designs and/or response models.

Using Stored Templates

- When you load a new test plan from the project node, any stored templates appear in the New Test Plan dialog box.

From the project node, select **File > New Test Plan**, or use the **toolbar** button, or click **New** in the **Test Plans** pane.

- Selecting templates in the New Test Plan dialog box displays all templates found in the directory specified in the Preferences dialog box (**File** menu).

Select by clicking to see the information on a particular template; the number of stages and factors is displayed in the **Information** pane. You can use the **Browse** button if the required template is not in the directory specified in the **File > Preferences** dialog box.

- Click **OK** to use the selected test plan template. The new test plan node appears in the model tree.

Use stored templates in exactly the same way as the default blank one- and two-stage templates. Models and input factors are already selected (including the response if that was saved with the template) so you can go straight to selecting new data to model. You can still change any settings and design experiments.

Double-click the Responses block to launch the Data Wizard and select data for the test plan. The response models are automatically built after selection of data.

Note The data selection process takes you through the Data Wizard. If any signal names in the new data do not match the template input factors, you must select them here, including the responses. If signal names match the factor names stored in the template, they are automatically selected by the Data Wizard, and you just click **Next** all the way to the end of the wizard. When you click **Finish** the response models are built automatically.

Use Test Plans to Set Up Designs, Data, and Models

In this section...

“Working With Test Plans” on page 2-15

“Setting Up Model Inputs” on page 2-17

“Setting Up Local, Global and Response Models” on page 2-18

“Designing Experiments” on page 2-19

“Selecting Data” on page 2-21

“Choosing Summary Statistics” on page 2-21

“Creating Boundary Models” on page 2-22

“Saving the Current Test Plan as a Template” on page 2-22

“Test Plan Tools” on page 2-22

Working With Test Plans

After you create a test plan, you can use the test plan view to set up model inputs, set up local, global, and response models, design experiments, select data for modeling, and create boundary models.

When you select a test plan node (with the icon ) in the model tree, this view appears.

The screenshot shows the Model Browser interface for a test plan named 'VVT'. The 'Number of stages' is set to 2. The 'Current selection' is 'Build new response model'. The diagram shows a flow from 'Local Inputs' (SPK (S) [deg]) through a 'Local Model' (Quadratic) to 'Responses' (BTQ (Nm), EXTEMP (K), RESIDFRAC (%)). A 'Global Model' (Quadratic) receives 'Global Inputs' (ENGSPD (N) [rpm], LOAD (L) [ratio], EXHCAM (EXH) [deg], INTCAM (INT) [deg]) and outputs 'RESIDFRAC (%)' to the 'Local Model'. A table at the bottom lists the response models and their performance metrics.

Response Models	Local RMSE	Two-Stage RMSE	Two-Stage T ²	-log L
BTQ	0.26765	0.72939	2.9241	-4987.319
EXTEMP	3.7302	4.9216	2.083	-1595.189
RESIDFRAC	0.020346	0.23825	3.0016	-5188.6071

This example is a two-stage model. All test plan nodes (one- and two-stage) show this view with a block diagram of the test plan. The diagram provides a graphical interface so you can set up inputs and set up models by double-clicking the blocks in the test plan diagram. These functions can also be reached using the **Test Plan** menu.

Use the diagram to set up the stages in hierarchical modeling. At present the toolbox only supports one- and two-stage models. The selected Model block is highlighted in yellow if a Setup dialog box is open; otherwise it is indicated by blocks at the corners. The selected Model block, local or global, indicates the stage of the model hierarchy that is used by the following menu choices:

- Set Up Model

- Design Experiment
- View Design Data
- View Model
- Summary Statistics

The following sections describe how to set up models, designs and data from your test plan. For a tutorial example setting up a simple example project with data, inputs, and local, global and response models, see “Empirical Engine Modelling”.

Setting Up Model Inputs

You set up the number and definition of model input factors for each stage by double-clicking or right-clicking the inports of the test plan block diagram. You can update ranges and symbols and refit existing models. Setting ranges can be important before you design experiments.

The following example shows the input setup dialog box for the global model. The dialog box for the local model contains exactly the same controls.

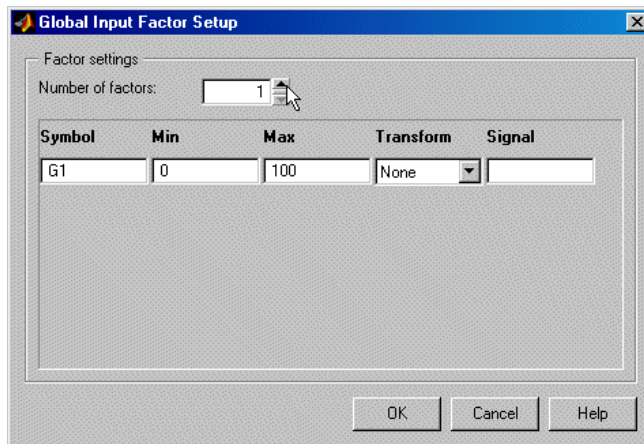

You can use the following controls:

- **Number of Factors**

You can change the number of input factors using the buttons at the top.

- **Symbol**

The input symbol is used as a shortened version of the signal name throughout the application. The symbol should contain a maximum of three characters.

- **Min and Max Model Range**

This setting is important before you design experiments. The default range is [0.100]. There is usually some knowledge about realistic ranges for variables. If you are not designing an experiment you can use the data range as the model range later, in the data selection stage. In some cases you might not want to use the data range (for example, if the data covers too wide a range, or not wide enough) if you are interested in modeling a particular region. In that case you can set the range of interest here.

- **Transform**

You can use input transformations to change the input factor for designing experiments. The available input transformations are $1/x$, \sqrt{x} , $\log_{10}(x)$, x^2 , $\log(x)$.

- **Signal**

You can set up the signal name in the input factor setup dialog box. It is not necessary to set this parameter at this stage, as it can be defined later at the data selection stage (as with the range). However, setting the signal name in this dialog box simplifies the data selection procedures, as the Model Browser looks for matching signal names in loaded data sets. When the number of data set variables is large this can save time.

Setting Up Local, Global and Response Models

Set up models by double-clicking the model blocks in the test plan diagram. Select model types to set up the new default models for each stage in the model hierarchy.

The block diagram in the test plan view represents the hierarchical structure of models. Following is an example of a two-stage test plan block diagram.

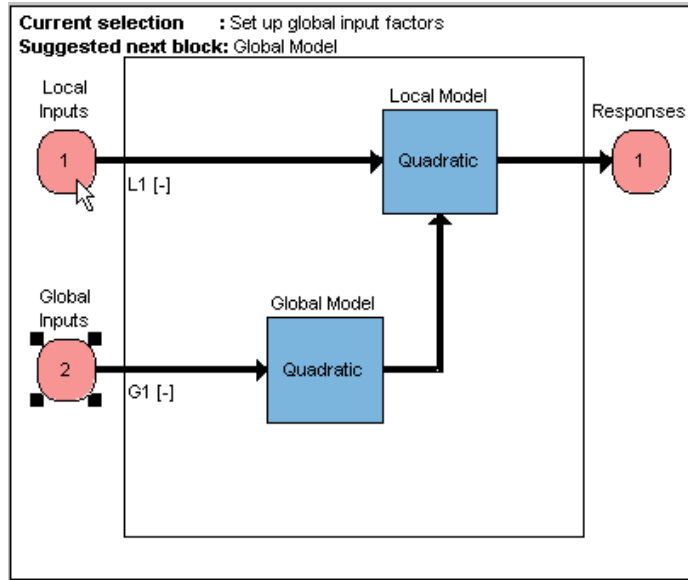

See “Local Model Setup” on page 5-4 and “Global Model Setup” on page 5-66 for information on all model options.

After you set up model types, you can design an experiment, or select data for fitting.

To choose data for fitting, double-click the Responses block in the Test Plan diagram to open the Data Wizard. For the same result, you could also click the Select Data toolbar button (or TestPlan > Select Data menu item).

When you first set up a test plan, the Data Wizard guides you through response model setup after the data matching functions. To add a new response model to an existing test plan, double-click the Responses outputport (or click the **New** button at test plan level). See “New Response Models and Datum Models” on page 5-87.

Designing Experiments

You can design experiments after setting up models and inputs. You can access the Design Editor from the test plan via the right-click menus on the model blocks, or the **TestPlan** menu (for a particular model—you must select

a model or input block before you can design an experiment). **View Design Data** also opens the Design Editor where you can investigate the statistical design properties of the data.

If the test plan already has a design, the design name is displayed in the right pane.

You can design experiments for both stages, local and global. You invoke the Design Editor in several ways from the test plan level:

- Right-click a Model block in the test plan diagram and select **Design Experiment**.

You must select (by clicking) a stage to design for (first or second stage) to enable the following two options:

- Click the **Design Experiment** toolbar button .
- Select **TestPlan > Design Experiment**.

For an existing design, **View > Design Data** also launches the Design Editor (also in the right-click menu on each Model block). In this case you can only view the current data being used as a design at this stage. If you enter the Design Editor by the other routes, you can view all alternative designs for that stage.

See “Design of Experiments”.

Viewing Designs

The view design facility enables the user to investigate the statistical properties of the current data.

From the test plan node, select the model stage you are interested in by clicking, then choose **View > Design Data**. Alternatively, use the right-click menu on a Model block.

This provides access to all the Design Editor and design evaluation utility functions with the current data rather than the prespecified design. If you have done some data-matching to a design, each data point is used as a design point. You can now investigate the statistical properties of this design.

For two-stage models, viewing stage one (local model) designs creates a separate design for each test.

See “Designing Experiments” on page 2-19 or the step-by-step guide in “Design of Experiment” in the Getting Started documentation.

Selecting Data

To load data, select **Test Plan > Load New Data**. See “Loading Data from File” on page 4-18.

To attach data to the test plan, double-click the Responses block in the test plan diagram to open the Data Wizard (if the project already has data loaded).

Alternatively, use **TestPlan > Select Data** or the toolbar button . If no data is selected, this button opens the Data Wizard, and if a data set is already selected for the test plan, it takes you straight to the Data Selection views in the Data Editor.

In the Data Editor you can select data for modeling and match data to a design. For example, after the design changes, new data matching might be necessary. See “Matching Data to Designs” on page 4-44 for details.

If a test plan already has data attached to it, details of the data set (such as name, number of records) are displayed in the right pane.

You can attach validation data to your test plan using the **TestPlan** menu. You can use validation data with any model except response features. When you attach validation data to your test plan, Validation RMSE is automatically added to the summary statistics for comparison in the bottom list view of response models in the test plan. See “Using Validation Data” on page 6-84.

If the test plan already has validation data attached to it, the name is displayed in the right pane.

Choosing Summary Statistics

Right-click the global model block in the test plan diagram and select **Summary Statistics** to reach the Summary Statistics dialog box. In this

dialog box you can choose which summary statistics you want displayed to help you evaluate models. See “Summary Statistics” on page 6-69.

Creating Boundary Models

From the test plan you can access the Boundary Constraint Modeling functionality from the toolbar or **TestPlan** menu. See “Boundary Model Setup” on page 5-46.

If the test plan already has a boundary model, the right pane displays which boundary models are combined in the best boundary model.

Saving the Current Test Plan as a Template

You can save the current test plan as a template using the **TestPlan > Make Template** command or the toolbar button . This capability can be useful for speeding up creation of subsequent projects. See “Creating New Test Plan Templates” on page 2-12.

Test Plan Tools

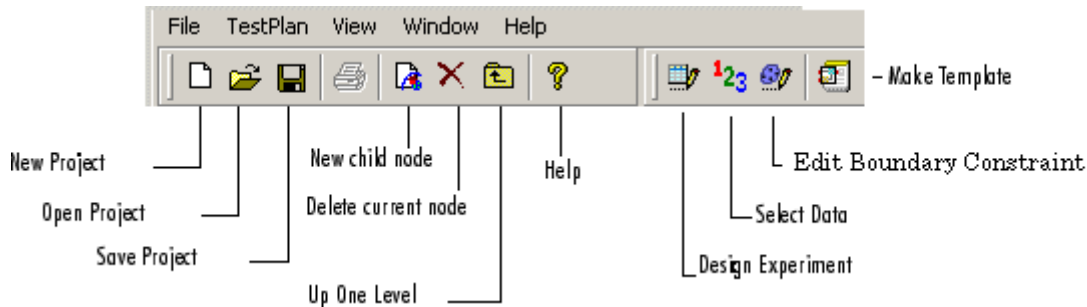

The eight buttons on the left (project and node management, plus the **Print** and **Help** buttons) appear in every view level. See “Use Project Tools” on page 2-7 for details.

The right buttons change at different levels.

In the test plan level view, the right buttons are as follows:

- **Design Experiment** opens the Design Editor. Only available when a model or input has been selected in the test plan block diagram. You must specify the stage (local or global) you are designing for. See .
- **Select Data** opens the Data Wizard, or opens the Data Selection views in the Data Editor if data sets have already been selected. See “Data Import and Processing”.
- **Edit Boundary Constraint** opens the Boundary Constraint Editor. See “Boundary Model Setup” on page 5-46.
- **Make Template** opens a dialog box to save the current test plan as a template, including any designs and response models. See “Examine Local Models” on page 6-2.

File Menu

Only the **New** (child node) and **Delete** (current node) functions change according to the node level currently selected. Otherwise the **File** menu remains constant. See “File Menu” on page 2-8.

Window Menu

The **Window** menu remains throughout the Model Browser. It allows you to switch windows if there is more than one toolbox window open. See “Window Menu” on page 2-10.

Help Menu

The **Help** menu remains the same throughout the Model Browser. You can always reach the MBC Toolbox Help Roadmap by selecting **Help > MBC Help**. The context help takes you to relevant Help pages, and **Help > About MBC** shows the version notes. See “Help Menu” on page 2-10.

Test Plan Menu

- **Set Up Inputs** — See “Setting Up Model Inputs” on page 2-17.
- **Set Up Model** — See “Local Model Setup” on page 5-4 and “Global Model Setup” on page 5-66.

You can also reach these functions by double-clicking the input and model blocks in the test plan diagram, and both can only be used when a Model

block is first selected in the diagram. You must specify the model to set up, local or global.

- **Design Experiment** — See “The Design Editor” on page 3-2.

This is also available in the toolbar and in the right-click context menu on the blocks in the test plan diagram.

- **Boundary Constraints** — Opens the Constraint Modeling window. Also available in the toolbar. See “Boundary Model Setup” on page 5-46.
- **New Data** — Opens the Data Editor to load new data.
- **Select Data** — Opens the Data Selection views of the Data Editor.

You can reach both these functions with the toolbar **Select Data** button. If no data is selected, this button opens the Data Wizard, and if a data set is already selected, it takes you straight to the Data Selection views. See “Data Import and Processing”.

- **Validation Data** Opens a wizard to select data for validation. See “Using Validation Data” on page 6-84.
- **Make Template** — Opens a dialog box for saving the current test plan as a new template, with or without designs and response models. Same as the toolbar button. See “Creating New Test Plan Templates” on page 2-12.
- **Export Multimodels** — This provides a smooth interface with the Multimodel Tradeoff in the CAGE browser part of Model-Based Calibration toolbox. Two global inputs are required (normally speed and load). This item is only enabled if you have set up a two-stage model with the correct number of inputs. This useful application for multiple models allows you to calibrate from local maps. See “Local Model Class: Multiple Models” on page 5-22 for details.

View Menu (Test Plan Level)

- **Design Data** — Opens the Design Editor. The view design facility enables you to investigate the statistical properties of the collected data. This provides access to all the Design Editor and design evaluation utility functions with the current design rather than the prespecified design (after data matching, the data points are used as the new design points). See “The Design Editor” on page 3-2.

For two-stage models, viewing level 1 designs creates a separate design for each test.

- **Model** — Opens a dialog box showing the terms in the current model.
- Both of these are only available when a model or input block is selected in the test plan block diagram.

Navigate the Model Tree

In this section...

“Navigating the Model Tree” on page 2-26

“Understanding Tree Structure” on page 2-27

“Icons: Curves, Worlds, and Houses” on page 2-28

“Icons: Blue Backgrounds and Purple Worlds” on page 2-29

Navigating the Model Tree

The tree in the **All Models** pane displays the hierarchical structure of the models you have built. Views and functionality within the browser differ according to which node is selected.

The following is an example of a model tree.

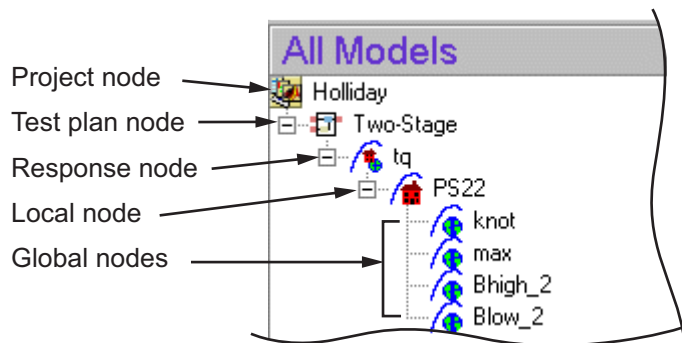

The elements of the tree consist of the following:

- 1 Project node
- 2 Test plan node
- 3 Response node
- 4 Local node

- 5 Global nodes — All one-stage model nodes are global models. For two-stage models, global models are fitted to response features of the local models. Each step down in the tree is a *child node* of the node above. Global models are child nodes of local nodes and so on.

Note The selected node in the tree governs the model that is displayed in the various other panes of the browser and which menu items are available. The selected node governs the level displayed: project level, test plan level, and so on. The functionality of each level is described in the Help.

You can rename all nodes, as in Windows Explorer, by clicking again or by pressing **F2** when a node is selected.

There is a context menu available. When you right-click any node in the model tree, you can choose to delete or rename that node, or create a new child node.

Understanding Tree Structure

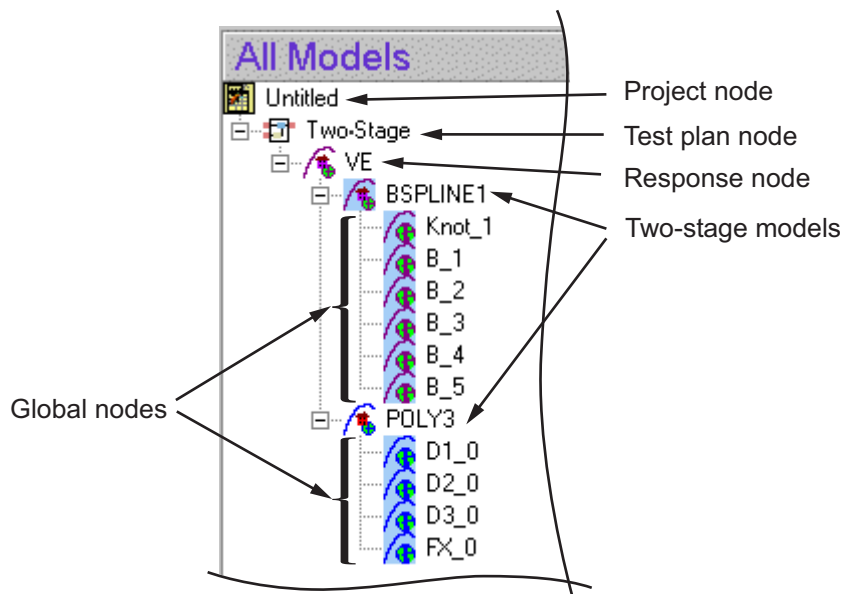

The preceding example shows a more extensive model tree, with two two-stage models as child nodes of a single response model.

There can be many models within (or under, as *child nodes* in the tree) each two-stage global node, or any one-stage model node.

There can also be many different response nodes within a single test plan, and each project can contain several different test plans. However, there is only one project node in the tree at any time.

Note You can only have one project open at any one time; if you open another, you are prompted to save or discard your current project.

You can add child nodes to all global models — several candidate models can be tried at each global node and the best selected. There is an example showing this at the end of the section on “Icons: Blue Backgrounds and Purple Worlds” on page 2-29 and the process is illustrated in the “Empirical Engine Modelling”.

Icons: Curves, Worlds, and Houses

The icons are designed to give visual reminders of their function.

- Test plan icons have a tiny representation of the test plan diagram. You can see the one-stage and two-stage icons in the following example.
- The local model icon shows a curve over a house.
- Global model icons show a curve over a globe. All one-stage models are global models and for two stage models, all nodes below the local node are global models.

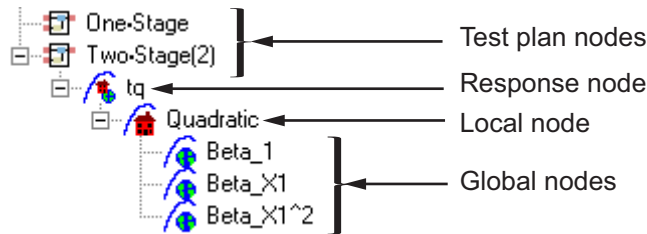

- The response node (empty until a two-stage model is calculated) has an icon that combines the local and global motifs — a curve over a house *and* a globe — to symbolize the two-stage process.
- When a two-stage model has been calculated, the icon at the local node changes to show the combination of local and global motifs.

Icons: Blue Backgrounds and Purple Worlds

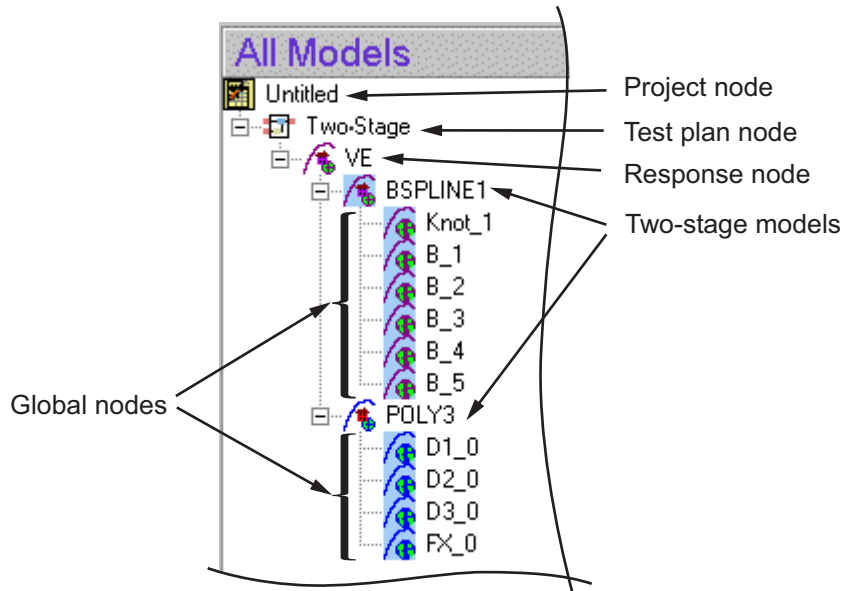

Icon changes convey information about modeling processes.

- When a model is selected as the *best model*, its icon changes color and gains a blue background, like the BSPLINE1 model in the preceding example.

- When the maximum likelihood estimate (MLE) is calculated and chosen as the best model, the associated model icon and all its child nodes (along with the plots of that model) become purple.

You can see this in the preceding example: the B Spline model and all its response features have purple curves, globes, and house, indicating that they are MLE models. The Poly3 model and its children have blue curves and globes and a red house, indicating that they are univariate models.

- Observe the other difference between the B Spline and the Poly3 icons: the B Spline has a blue background. This indicates that this is selected as best model, and is used to calculate the two-stage model at the response node, so the response node is also purple. If an MLE model (with purple worlds) is selected as best model and is used to create the two-stage model, the response node always reflects this and is also purple.
- Notice also that the response features all have blue backgrounds. This shows they are selected as best and are all being used to calculate the two-stage model. In this case they are all needed. That is, a B Spline model needs six response features, and a Poly3 model requires four. If more response features are added, however, some combination must be selected as best, and the response features not in use do not have a blue background. An example is shown in “Empirical Engine Modelling”.

In the following example you can see child nodes of a global model. You can try different models within a global model, and you must select one of the attempts as best. In this example you can see that Cubic is selected as best, because it has a blue background, so it is the model being used for the Blow_2 global model.

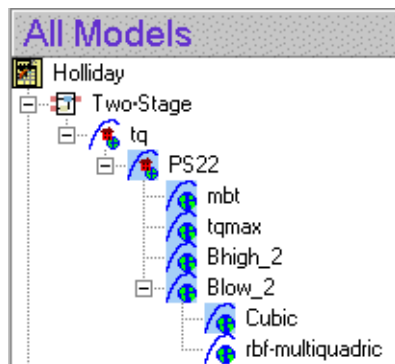

When a model is selected as best it is copied up a level in the tree together with the outliers for that model fit.

When a new global or local model is created the parent model and outliers are copied from the current level to the new child node. This gives a mechanism for copying outliers around the model tree.

A tree node is automatically selected as best if it is the only child, except two-stage models which are never automatically selected - you must use the Model Selection window.

If a best model node is changed the parent node loses best model status (but the automatic selection process will reselect that best model if it is the only child node).

Note Try the Quick Start tutorial in the Getting Started documentation to understand how to use the model tree. The last section, “Create Multiple Models to Compare”, guides you through the process of creating a variety of models of different types and how to understand the information in the model tree. You need to complete the previous sections of the tutorial first, which guides you through setting up a single two-stage model to get started.

Designs

This section discusses the following topics:

- “The Design Editor” on page 3-2
- “Creating a Classical Design” on page 3-16
- “Creating a Space-Filling Design” on page 3-19
- “Creating an Optimal Design” on page 3-31
- “Adding and Editing Design Points” on page 3-42
- “Merging Designs” on page 3-45
- “Fixing, Deleting, and Sorting Design Points” on page 3-47
- “Exporting and Importing Designs” on page 3-50
- “Applying Constraints” on page 3-51
- “Prediction Error Variance Viewer” on page 3-63
- “Design Evaluation Tool” on page 3-71

The Design Editor

In this section...

“Introducing the Design Editor” on page 3-2

“Opening the Design Editor” on page 3-2

“Design Styles” on page 3-4

“Design Editor Displays” on page 3-5

“Design Editor Toolbar and Menus” on page 3-9

Introducing the Design Editor

The Design Editor provides prebuilt standard designs to allow a user with a minimal knowledge of the subject to quickly create experiments. You can apply engineering knowledge to define variable ranges and apply constraints to exclude impractical points. You can increase modeling sophistication by altering optimality criteria, forcing or removing specific design points, and optimally augmenting existing designs with additional points.

There is a step-by-step guide to using the Design Editor in “Design of Experiment”.

Opening the Design Editor

You must first have a test plan before you can open the Design Editor.

- 1 From the startup (project) view of the Model Browser, click **New** and select a one or two-stage test plan. See “Work with Model Browser Projects” on page 2-2 and “Create Test Plans” on page 2-11 in the Modeling section.

You can design experiments at both stages, for local models and global models; for most two-stage models the global model is most appropriate for design of experiment.

- 2 Before you design an experiment we recommend that you set up your input variables, by double-clicking the Inputs blocks on the test plan diagram. See “Setting Up Model Inputs” on page 2-17.

You can choose the number of inputs for your model and set up their names and definitions, then you can design an experiment to collect data. It is much easier to understand your design points if they are labeled with the factor names. Also, if you do not set up model inputs first, then you can only create designs for the default number of variables (one).

- 3** If you want to use optimal designs, then the type of model you are going to use to fit the data is important, and you should choose a model type before opening the Design Editor. Double-click a model block in the test plan diagram to set up model types. Optimal designs are best for cases with high system knowledge, where previous studies have given confidence on the best type of model to be fitted, so in these cases you should pick your model type before designing an experiment. See to find out about model types in the Model-Based Calibration Toolbox product.

If you have no idea what model you are going to fit, choose a space-filling design. Model type has no effect on designs that are space-filling or classical, so if you want to create these designs you can leave the model type at the default and open the Design Editor.

You can invoke the Design Editor in several ways from the “Use Test Plans to Set Up Designs, Data, and Models” on page 2-15:

- 1** First you must select the stage (first/local or second/global) for which you want to design an experiment. Click to select the appropriate model block in the test plan diagram.
- 2** Right-click the model block and select **Design Experiment**.

Alternatively, click the **Design Experiment** toolbar icon .

You can also select **TestPlan > Design Experiment**.

For an existing design, **View > Design Data** also launches the Design Editor (also in the right-click menu on each Model block). This shows the selected data as a design.

Design Styles

The Design Editor provides the interface for building experimental designs. You can make three different styles of design: classical, space-filling, and optimal.

Classical designs (including full factorial) are very well researched and are suitable for simple regions (hypercube or sphere). See “Creating a Classical Design” on page 3-16.

Space-filling designs are better when there is low system knowledge. In cases where you are not sure what type of model is appropriate, and the constraints are uncertain, space-filling designs collect data in such a way as to maximize coverage of the factors’ ranges as quickly as possible. See “Creating a Space-Filling Design” on page 3-19.

Optimal designs are best for cases with high system knowledge, where previous studies have given confidence in the best type of model to be fitted, and the constraints of the system are well understood. See “Creating an Optimal Design” on page 3-31.

You can augment any design by optimally adding points. Working in this way allows new experiments to enhance the original, rather than simply being a second attempt to gain the necessary knowledge. See “Adding and Editing Design Points” on page 3-42.

Design Editor Displays

The following example shows the display after creating an optimal design.

The screenshot shows the Design Editor window with the following components:

- Design Tree:** Shows a hierarchy of designs: Designs, Radial Basis Function Design, Actual Design, and AugmentedDesign.
- Design Table:** A table displaying design points with their respective values. A context menu is open over the table, showing options like 'Current View', 'Viewer Options', 'Display Design Point Numbers', 'Split Vertically', 'Split Horizontally', 'Delete Current View', and 'Print to Figure'. The '3D Design Projection' option is selected.
- Properties - AugmentedDesign:** A table showing design parameters: Design Style (Custom), Number of Points (264), Number of Constraints (0), Last Changed (13-Feb-2003, ...), and Model (RBF-multiqua...).

Design Point	Value 1	Value 2	Value 3	Value 4	Value 5
243	4452.906	0.503			
244	4587.575	0.528	9.88	31.593	
245	1219.158	0.574	6	-2.25	
246	4782.004	0.599	17	14.25	
247	3943.687	0.599	-2.25	41.75	
248	2057.475	0.474	6	-5	
249	2267.054	0.424	47.25	0.5	
250	4572.425	0.499	8.75	6	
251	2686.212	0.624	3.25	6	
252	4153.267	0.424	33.5	28	
253	4572.425	0.299	36.25	8.75	
254	2057.475	0.649	3.25	6	

When you first create or open a design, the main display area shows the default **Design Table** view of the design (see example above). All the views on the right show the design selected in the left tree (see “The Design Tree” on page 3-7). There is a context menu for the views on the right, available by right-clicking the title bars, in which you can change the view of the design to **1-D**, **2-D**, **3-D**, **4-D**, and **Pairwise Projections**, **2-D**, and **3-D Constraint** views, and the **Table** view (also under **View** menu). This menu also allows you to split the display either horizontally or vertically so that you simultaneously have two different views on the current design. The split can also be merged again. You can also use the toolbar buttons. After splitting, each view has the same functionality; that is, you can continue

to split views until you have as many as you want. When you click a view, its title bar becomes blue to show it is the current active view. See “Design Editor Toolbar and Menus” on page 3-9 for more information about how to change your display options.

The information pane, bottom left, displays pieces of information for the current design selected in the tree. The amount of information in this pane can change depending on what the design is capable of; for example, only certain models can support the optimal designs and only these can show current optimal values. You can also see this information and more by selecting **File > Properties** or using the context menu in the tree.

The Design Editor can display multiple design views at once, so while working on a design you can keep a table of design points open in one corner of the window, a 3-D projection of the constraints below it, and a 2-D, 3-D, or pairwise plot of the current design points as the main plot.

The following example shows several views in use at once.

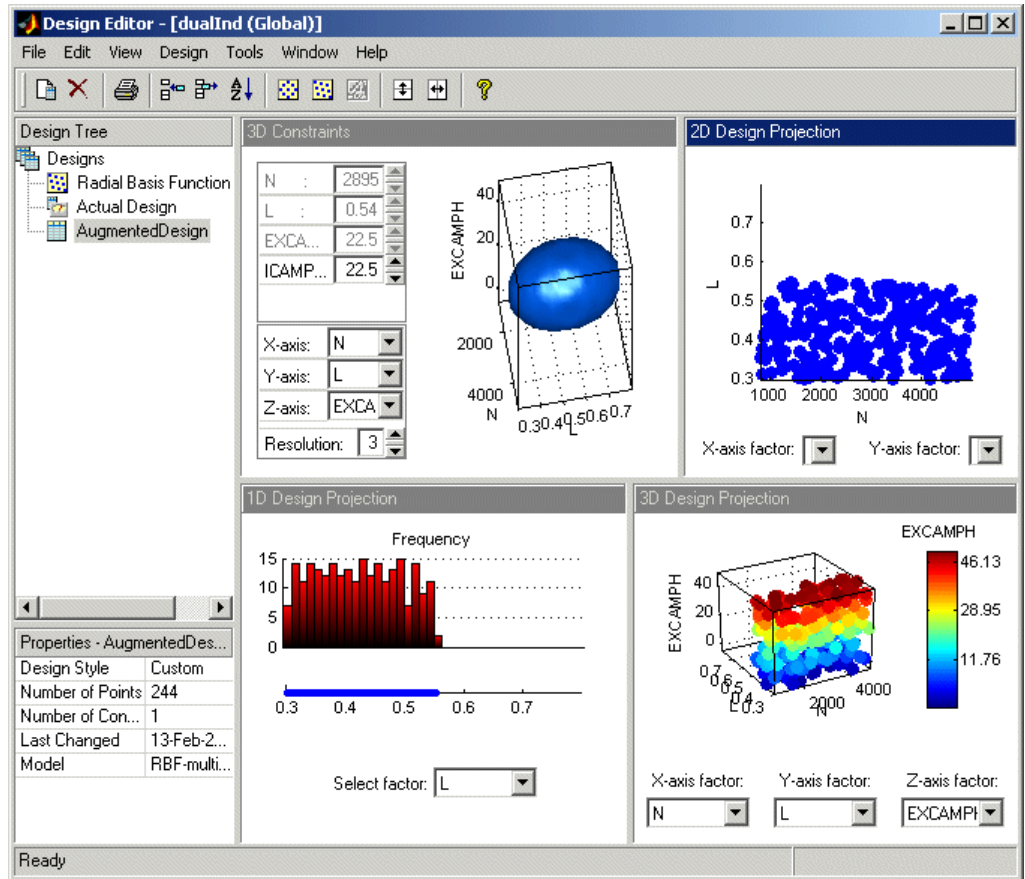





The Design Tree

The currently available designs are displayed on the left in a tree structure.

The tree displays three pieces of information:

- The name of the design, which you can edit by clicking it
- The state of the design

- The icon changes from  if it is empty, to the appropriate icon for the design type when it has design points (for example,  optimized, as in the toolbar buttons for Optimal, Classical, and Space-Filling designs).
- The icon changes to  when design points have been added using a different method (for example, augmenting a classical design with optimally chosen points). It becomes a *custom* design style. You can mix and match all design options in this way.
- A padlock appears () if the design is locked. This happens when it has child nodes (to maintain the relationship between designs, so you can retreat back up the design tree to reverse changes).
- The design that is selected as best. This is the default design that is used for matching against experimental data. The icon for the selected design is the normal icon turned blue. When you have created more than one design, you should select as best the design to be used in modeling, using the **Edit** menu. Blue icons are also locked designs, and do not acquire padlocks when they have child nodes.
- You can reach a context menu by right-clicking in the design tree pane. Here you can delete or rename designs and add new designs. Choose **Evaluate Design** to open the Design Evaluation window. **Properties** opens the Design Properties dialog box, which displays information about the size, constraints, properties (such as optimality values), and modification dates of the selected design.

Design Editor Toolbar and Menus

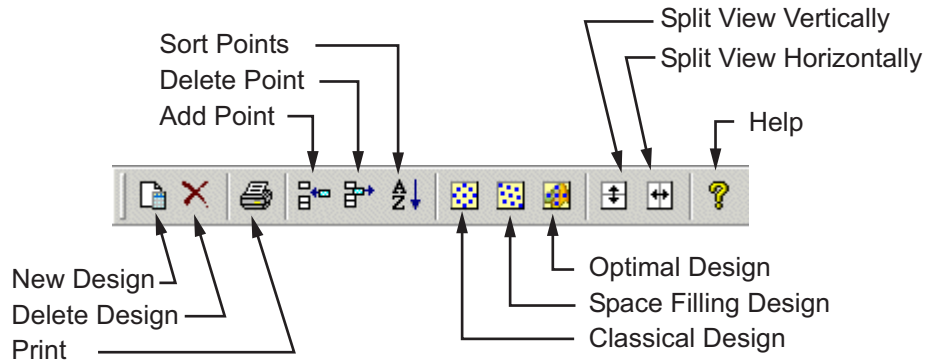

- **New Design, Delete Design, Print** — See the “File Menu” on page 3-9.
- **Add, Delete and Sort Point** — See the “Edit Menu” on page 3-11.
- **Classical, Space Filling and Optimal Design** — See the “Design Menu” on page 3-14.
- **Split View Horizontally and Vertically**— See the “View Menu” on page 3-12.

File Menu

- **New Design** — Creates a new design node in the tree. This is blank if it is the first design you create, or, if you have an existing design, the child node is a copy of the parent design. Also in the toolbar and the context menu in the design tree. Use the **Design** menu or toolbar buttons to set up designs.
- **Delete Design** — Deletes the currently selected design and its subdesigns. Also in the toolbar and the context menu in the design tree.
- **Rename Design** — Enables you to edit the name of the current design. You can also do this by clicking again on the selected design name, or right-click to use the context menu in the design tree.
- **Properties** — Opens the Design Properties dialog box, where you can see information about your current design, such as the number of factors, points, and constraints; the design style; when the design was last modified;

optimality values, space filling, and classical settings. Also in the context menu in the design tree.

- **Import Design** — Opens the Import Design dialog box, where you can import designs from Design Editor files (*.mvd), comma-separated-values files (*.csv), or from the workspace. You can browse to the required file or specify the source variable if importing from the workspace. If it is not a Design Editor file you can choose to convert the design points from [-1, 1] range. See “Exporting and Importing Designs” on page 3-50.
- **Export Design** — Opens the Export Design dialog box, where you can export designs to Design Editor files (*.mvd), comma-separated-values files (*.csv), or from the workspace. You can specify the name of the destination file or variable. For .csv files you can use the check box to choose whether to include factor names, and for the workspace and .csv files you can choose whether to convert design points to [-1, 1] range. See “Exporting and Importing Designs” on page 3-50. Note that you do not have to export your designs to save them — they are saved when you save your project in the Model Browser.
- **Merge Designs** — Opens the Merge Designs dialog box, where you can choose which designs to merge and a base design. See “Merging Designs” on page 3-45.
- **Import Constraints** — Opens the Import Constraints dialog box. Here you can import any suitable constraints for the currently selected design. You can import any existing constraints in the design tree, or from a design file, or you can import boundary constraints from file or the current project. See “Importing Constraints” on page 3-60.
- **Print** — Prints the current view (plots only). You can also use **Print Preview**. See also **Print to Figure** in the **View** menu. If you want to print information from the Table view you can copy the information to the clipboard by using **Edit > Copy Design Data**, or save the design as a .csv file. Also in the toolbar.
- **Close** — Closes the Design Editor. You return to the Model Browser window. Note that you do not lose your designs, you simply close the Design Editor. The designs reappear when you reopen the Design Editor. When you save your project in the Model Browser your designs remain part of that project.

Edit Menu

- **Copy View** — Copies the current view to the clipboard.
- **Copy Design Data** — Copies the design data to the clipboard. This can be useful if you want to print the contents of the Table view.
- **Clear** — Deletes all points in the current design.
- **Add Point** — Opens the Add Design Points dialog box. Here you can choose how many points to add optimally, randomly, or at specified points. Also in the toolbar. See “Adding and Editing Design Points” on page 3-42.
- **Delete Point** — Opens the Delete Design Points dialog box. Here you can choose the points to delete. Also in the toolbar. See “Fixing, Deleting, and Sorting Design Points” on page 3-47.
- **Sort Points** — Opens the Sort dialog box. Here you can choose to sort by any or all of your factors, by custom expression, or at random. Also in the toolbar. See “Fixing, Deleting, and Sorting Design Points” on page 3-47.
- **Fix/Free Points** — Opens the Fix Design Points dialog box. You can fix design points so they are not moved by design optimization processes. See “Fixing, Deleting, and Sorting Design Points” on page 3-47.
- **Randomize** — Select this option as a quick way of randomly resorting the points in the current design. This is a shortcut to the same functionality provided by the **Random** option in the Sort dialog box.
- **Round Factor** — Opens the Round Design dialog box. Here you can select a factor to round, and limit it to:
 - A fixed interval, with optional offset (e.g., an interval of 5 and an offset of 2 rounds to [... -8 -3 2 7 12 17 ...])
 - A specified number of significant figures
 - Specified levels
- **Constraints** — Opens the Constraints Manager dialog box. Here you can add, edit, duplicate, and delete constraints on your designs. See “Applying Constraints” on page 3-51.
- **Model** — Opens the Global or Local Model Setup dialog box (depending on which stage you are designing an experiment for). Here you can change

the model for which you are designing an experiment. The model type is important for optimal designs.

- **Select As Best** — Selects the current design as best. This changes the icon in the tree blue. This is the default design that is used for matching against experimental data.

View Menu

- **Current View** — Changes the current view to your selection from the submenu:
 - Design Table
 - 1-D Design Projection
 - 2-D Design Projection
 - 3-D Design Projection
 - 4-D Design Projection
 - Pairwise Design Projections
 - 2-D Constraints
 - 3-D Constraints
 - Model Description
- **View Options** — these items depend on the currently selected view:
 - **Plot Properties**— For 1-D, 2-D and 3-D Design Projections. Opens dialog boxes for configuring details of the current display. You can change basic properties such as color on the projections (1-D, 2-D, 3-D, and 4-D). You can rotate all 3-D views as usual.
 - **Edit Colormap** For the 3-D and 4-D Design Projections. You can also double-click the color bar to edit the colormap.
 - **Graph Size** For the Pairwise Projections, you can choose graph size or to display all graphs.
 - **Value Filter** — For the table view, you can set up a filter to selectively display certain ranges of values.

- **Display Design Point Numbers** — You can select this option to toggle the display of design point numbers in views that support the feature. A design point number is the index of a particular point in the design: this value is permanently displayed in the table view. Views that support the display of design point numbers are
 - 2-D Design Projection
 - 3-D Design Projection
 - 4-D Design Projection
 - Pairwise Design Projections

Because all these views are projections that use a subset of the design's input factors, it is often the case that the resulting view contains points that have been plotted on top of each other. In this case, the design point numbers will stack up in a column above the common point to aid readability. You can use **Display Design Point Count** to see at a glance how many points are overlapping in any stack. You can select point count or point numbers but not both.

Note Displaying multiple views with design point numbers for large designs can significantly slow down the display. You might want to turn off the design point number display in these cases.

- **Display Design Point Count** — If points are plotted on top of each other (in 2-D, 3-D, 4-D, or pairwise plots) this option allows you to see how many points are overlapping in each cluster. A number next to a point indicates that more than one point is plotted there.
- **Split View** — splits the current view and adds your selected new view from the submenu.
- **Split View Vertically** — Splits the current view vertically to produce a new view in addition to the currently selected view. Also in the toolbar and the buttons in the title bar of each view. New plot types are produced for each new view. This is a quick way to produce a variety of different plots. Remember that you can change any existing view type by selecting **View > Current View** or, alternatively, using the context menu to select from the **Current View** submenu.

- **Split View Horizontally** — Splits the current view horizontally to produce new views, as for **Split Vertically**. Also in the toolbar and the buttons in the title bar of each view.
- **Close View** — Deletes the current view.
- **Print to Figure** — This option copies the current view into its own figure, allowing you to use the standard MATLAB plotting tools to annotate and print the display.

Design Menu

- **Optimal** — Opens the Optimal Design dialog box. Also in the toolbar. See “Creating an Optimal Design” on page 3-31.
- **Classical** — You can use the submenu here to go directly to the type of classical design you want, or select **Design Browser** to see all the options. See “Creating a Classical Design” on page 3-16. The toolbar button opens the Design Browser.
- **Space Filling** — You can use this submenu to go directly to the type of space filling design you want, or select **Design Browser** to see all the options. See “Creating a Space-Filling Design” on page 3-19. The toolbar button opens the Design Browser.

Tools Menu

- **Prediction Error Variance Viewer** — Opens the Prediction Error Variance Viewer where you can evaluate the predictive power of your designs. See “Prediction Error Variance Viewer” on page 3-63.
- **Evaluate Designs** — Opens the Design Evaluation window where you can examine detailed mathematical properties of your design. Also in the context menu in the design tree. See “Design Evaluation Tool” on page 3-71.



Window Menu

This allows you to switch between the Model Browser and Design Editor windows.

Help Menu

As with everywhere in the toolbox, the **Help** menu provides access to general toolbox help and help specific to the current view. Here you can select **MBC Help** to browse all the toolbox help, **Design Editor Help** to go straight to the Designs documentation, or **About MBC** to see the current version number.

Creating a Classical Design

- 1** Add a new design by clicking the  button in the toolbar or select **File > New**.
- 2** Select the new design node in the tree. An empty Design Table appears if you have not yet chosen a design. Otherwise if this is a new child node the display remains the same, because child nodes inherit all the parent design's properties. All the points from the previous design remain, to be deleted or added to as necessary. The new design inherits all its initial settings from the currently selected design and becomes a child node of that design.
- 3** Click the  button in the toolbar or select **Design > Classical > Design Browser**.

Note In cases where the preferred type of classical design is known, you can go straight to one of the five options under **Design > Classical**. Choosing the **Design Browser** option allows you to see graphical previews of these same five options before making a choice.

- 4** A dialog box appears if there are already points from the previous design. You must choose between replacing and adding to those points or keeping only fixed points from the design. The default is replacement of the current points with a new design. Click **OK** to proceed, or **Cancel** to change your mind.

The Classical Design Browser appears.

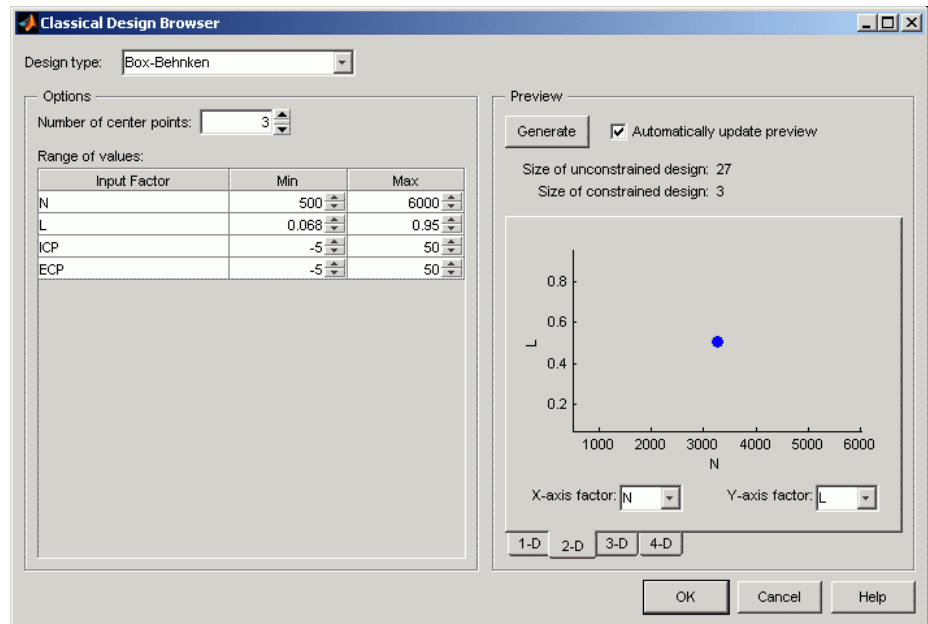

In the **Design Style** drop-down menu there are five classical design options:

- **Central Composite**

Generates a design that has a center point, a point at each of the design volume corners, and a point at the center of each of the design volume faces. The options are **Face-center cube**, **Spherical**, **Rotatable**, or **Custom**. If you choose **Custom**, you can then choose a ratio value (α) between the corner points and the face points for each factor and the number of center points to add. Five levels for each factor are used. You can set the ranges for each factor. **Inscribe star points** scales all points within the coded values of 1 and -1 (instead of plus or minus α outside that range). When this box is not selected, the points are circumscribed.

A Central-Composite design consists of factorial points in the corners of the space, plus axial points in the direction of the design face centers that can have their distance varied by the alpha factor. For values of alpha, see “Classical Design Properties” in the Properties (for design generators) reference page.

Spherical arranges the axial design points so that both they and the factorial points lie on the same geometric circle/sphere/hypersphere.

Rotatable means that the prediction variance pattern of the design is spherically-symmetric, that is, rotating the design in any direction has no impact on the prediction quality of a model that results from the experiment.

With 2 factors the rotatable design is also circular, but in higher dimensions the rotatable designs have closer axial points than the spherical designs.

- **Box-Behnken**

Similar to Central Composite designs, but only three levels per factor are required, and the design is always spherical in shape. All the design points (except the center point) lie on the same sphere, so you should choose at least three to five runs at the center point. There are no face points. These designs are particularly suited to spherical regions, when prediction at the corners is not required. You can set the ranges of each factor.

- **Full Factorial**

Generates an n -dimensional grid of points. You can choose the number of levels for each factor, the number of additional center points to add, and the ranges for each factor.

- **Plackett Burman**

These are “screening” designs. They are two-level designs that are designed to allow you to work out which factors are contributing any effect to the model while using the minimum number of runs. For example, for a 30-factor problem this can be done with 32 runs. They are constructed from Hadamard matrices and are a class of two-level orthogonal array.

- **Regular Simplex**

These designs are generated by taking the vertices of a k -dimensional regular simplex (k = number of factors). For two factors a simplex is a triangle; for three it is a tetrahedron. Above that are hyperdimensional simplices. These are economical first-order designs that are a possible alternative to Plackett Burman or full factorials.

Creating a Space-Filling Design

In this section...

“Introducing Space-Filling Designs” on page 3-19

“Setting Up a Space-Filling Design” on page 3-20

“Halton Sequence” on page 3-21

“Sobol Sequence” on page 3-22

“Latin Hypercube Sampling” on page 3-23



“Lattice” on page 3-24

“Stratified Latin Hypercube” on page 3-25

“Augmenting Space-Filling Designs” on page 3-26

Introducing Space-Filling Designs

Space-filling designs should be used when there is little or no information about the underlying effects of factors on responses. For example, they are most useful when you are faced with a new type of engine, with little knowledge of the operating envelope. These designs do not assume a particular model form. The aim is to spread the points as evenly as possible around the operating space. These designs literally fill out the n -dimensional space with points that are in some way regularly spaced. These designs can be especially useful in conjunction with nonparametric models such as radial basis function (a type of neural network).

- 1** Add a new design by clicking the  button in the toolbar or select **File > New**.
- 2** Select the node in the tree by clicking. An empty Design Table appears if you have not yet chosen a design. Otherwise, if this is a new child node the display remains the same, because child nodes inherit all the parent design's properties.
- 3** Select **Design > Space Filling > Design Browser**, or click the **Space Filling Design** button  on the toolbar.

- 4 A dialog box appears if there are already points from the previous design. You must choose between replacing and adding to those points or keeping only fixed points from the design. The default is replacement of the current points with a new design. Click **OK** to proceed, or **Cancel** to change your mind.

The Space Filling Design Browser appears.

Note As with the Classical Design Browser, you can select the types of design you can preview in the Space Filling Design Browser from the **Design > Space Filling** menu in situations when you already know the type of space-filling design you want.

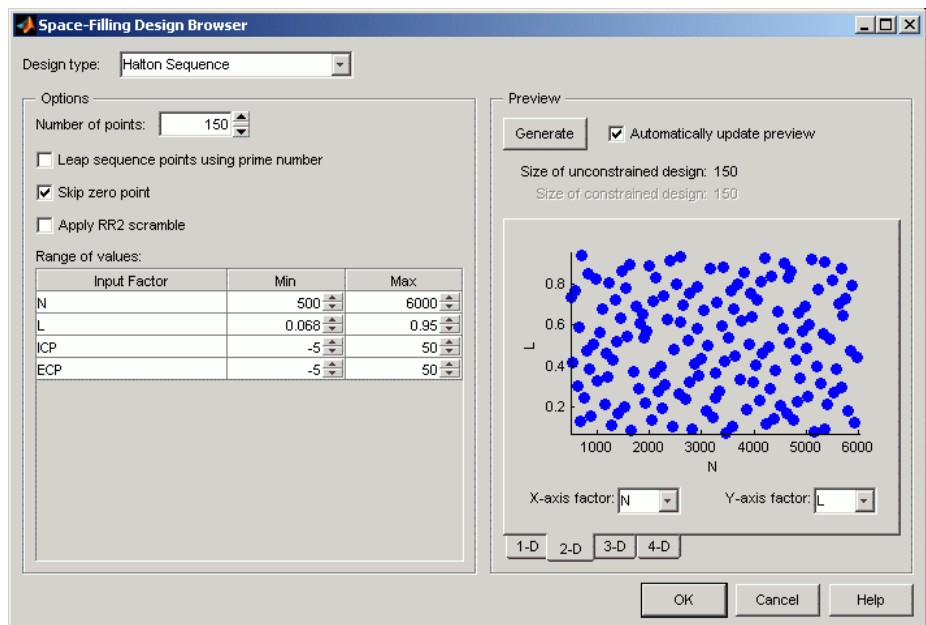

Setting Up a Space-Filling Design

For all design types, you can edit these settings:

- Select from the **Design type** drop-down menu to choose a space-filling design style.

The default **Design type** is Halton Sequence.

- You can set the **Number of points** by typing in the edit box or using the controls.

Observe the information displayed above the preview to see how many points are excluded by constraints.

Alter the number of points until the **Size of constrained design** displays the number of points you want.

- You can use the tabs under the display to view 2-D, 3-D, and 4-D previews. The preview is identical to the final design.

When you edit settings for very large designs, you can clear the check box **Automatically update preview** to avoid waiting for the preview calculation. This check box is cleared automatically if the current design is large enough to cause preview calculation to be very slow. You can click the **Generate** button when you want to create a preview.

- You can set the ranges for each factor.
- For settings for specific design types, see the sections for each type:
 - “Halton Sequence” on page 3-21
 - “Sobol Sequence” on page 3-22
 - “Latin Hypercube Sampling” on page 3-23
 - “Lattice” on page 3-24
 - “Stratified Latin Hypercube” on page 3-25
- Click **OK** to calculate the design and return to the main Design Editor.

Halton Sequence

Halton Sequence designs are generated from the `haltonset` class in the Statistics Toolbox™ software. The Halton sequence is a low-discrepancy point set where the coordinate values for each dimension are generated by forming the radical inverse of the point’s index, using a different prime base for each dimension. For more information see the Statistics Toolbox documentation.

Settings

For Halton sequence designs, you can choose the following options:

- **Leap sequence points using prime number** — Uses only every k -th point in the Halton sequence. k is the next prime number after those used as bases in the radical inverse; i.e., this value is the $(N\text{Factors}+1)$ prime number.

This property at the command line is `PrimeLeap`.

- **Skip zero point** — Causes the first point of the sequence, which is always at the lower limit of each input factor, to be skipped. This point is often seen as unbalancing because the upper limits of each input factor can never be produced by the algorithm.

This property at the command line is `SkipZero`.

- **Apply RR2 Scramble** — Sets the scramble to 'RR2', which performs a permutation of the radical inverse coefficients using the RR2 algorithm.

This property at the command line is `Scramble`.

Sobol Sequence

Sobol sequence designs are generated from the `sobolset` class in the Statistics Toolbox software. The Sobol sequence is a low-discrepancy (t,s)-sequence in base 2. For more information see the Statistics Toolbox documentation.

Settings

For Sobol sequence designs, you can choose the following options:

- Use the radio buttons to specify whether and how to skip initial points from the sequence:

- **No skip** — Do not skip any points.

This property at the command line is `SkipMode 'None'`.

- **Skip initial 2^k points** — Automatically chooses the smallest value for k so that 2^k is larger than the number of points requested, and then skip 2^k points.

This property at the command line is `SkipMode '2^k'`.

- **Custom skip** — Enter a value to be used as the number of initial points to miss out from the sequence.
This property at the command line is `SkipMode`, `'Custom'`, `Skip`, `Numberofpoints`.
- **Apply Matousek Affine Owen scramble** — Performs a linear scramble of the generator matrices for the sequence using random lower-triangular matrices in base 2 and also applies a random digital shift to the points.
This property at the command line is `Scramble`.

Latin Hypercube Sampling

Latin Hypercube Sampling (LHS) designs are sets of design points that, for an N point design, project onto N different levels in each factor. In this design, the points are generated randomly. You choose a particular Latin Hypercube by trying several such sets of randomly generated points and choosing the one that best satisfies user-specified criteria.

Settings

For both Latin Hypercube Sampling and Stratified Latin Hypercube, you can choose the following options:

- The **Selection criteria** drop-down menu has these options:
 - Maximize minimum distance (between points).
 - Minimize maximum distance (between points)
 - Minimize discrepancy — Minimizes the deviation from the average point density
 - Minimize RMS variation from CDF — This default option minimizes the Root Mean Square (RMS) variation of the Cumulative Distribution Function (CDF) from the ideal CDF.
 - Minimize maximum variation from CDF — Minimizes the maximum variation of the CDF from the ideal CDF

The final two (CDF variation) options scale best with the number of points and it is advisable to choose one of these options for large designs.

- The **Enforce Symmetrical Points** check box is selected by default. This creates a design in which every design point has a *mirror* design point on the opposite side of the center of the design volume and an equal distance away. Restricting the design in this way tends to produce better Latin Hypercubes.

Lattice

Lattice designs project onto N different levels per factor for N points. The points are not randomly generated but are produced by an algorithm that uses a prime number per factor. If good prime numbers are chosen, the lattice spreads points evenly throughout the design volume. A poor choice of prime numbers results in highly visible lines or planes in the design projections. If all the design points are clustered into one or two planes, it is likely that you cannot estimate all the effects in a more complex model. When design points are projected onto any axes, there are a large number of factor levels.

For a small number of trials (relative to the number of factors) LHS designs are preferred to Lattice designs. This is because of the way Lattice designs are generated. Lattice designs use prime numbers to generate each successive sampling for each factor in a different place. No two factors can have the same generator, because in such cases the lattice points all fall on the main diagonal of that particular pairwise projection, creating the visible lines or planes described above. When the number of points is small relative to the number of factors, the choice of generators is restricted and this can lead to Lattice designs with poor projection properties in some pairwise dimensions, in which the points lie on diagonals or double or triple diagonals. This means that Latin Hypercube designs are a better choice for these cases.

See the illustrations in the following section comparing the properties of good and poor lattices and a hypercube design.

Settings

For a Lattice space-filling design, you can choose:

- The **Lattice size** by using the buttons or typing in the edit box.
- The prime number generator by using the up/down buttons on the **Prime number for X** edit box.
- The range for each factor.

Stratified Latin Hypercube

Stratified Latin Hypercubes separate the normal hypercube into N different levels on user-specified factors. This can be useful for situations where the preferred number of levels for certain factors might be known; more detail might be required to model the behavior of some factors than others. They can also be useful when certain factors can only be run at given levels.

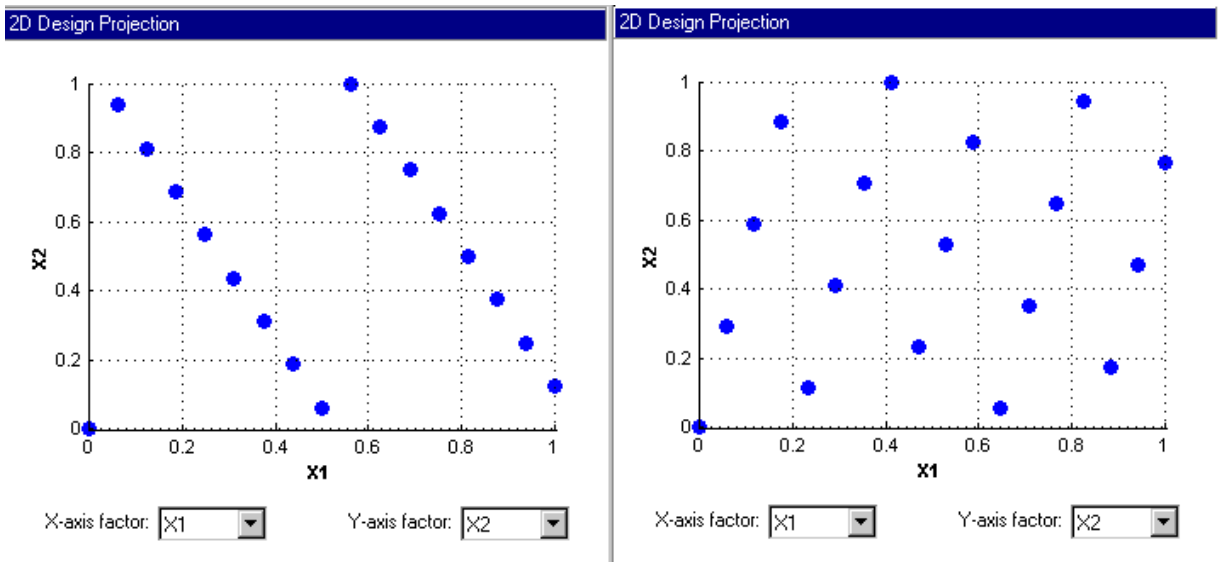

The preceding example shows the different properties of a poor lattice (left) and a good lattice (right), with a similar number of points. The poorly chosen prime number produces highly visible planes and does not cover the space well.

An example of an LHS design of the same size is shown for comparison with the preceding lattice examples.

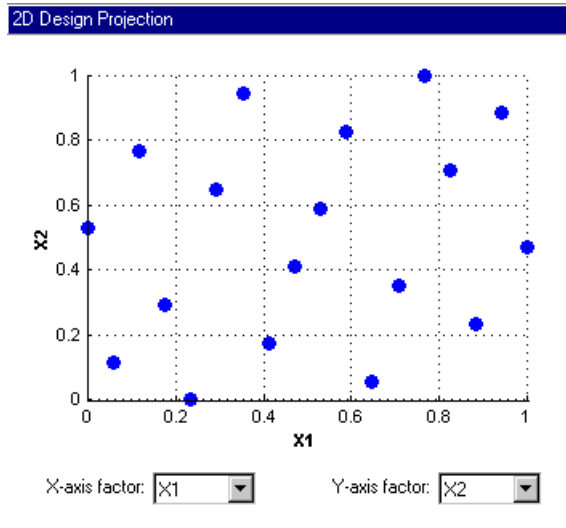

Settings

See “Latin Hypercube Sampling” on page 3-23, the options are the same.

Comparing Latin Hypercube and Stratified Latin Hypercube

Latin Hypercube Sampling and Stratified Latin Hypercube Sampling differ only in that with Stratified Latin Hypercube Sampling, you can restrict the number of levels available to each factor. If the number of stratifications equals the number of points in the design, then both Latin Hypercube Sampling and Stratified Latin Hypercube Sampling give the same results. However, if the number of stratifications in a given factor is less than the number of points in the design, then some points will be projected onto the same values in that factor. You can see this change by using the one-dimensional design projection view in the Design Editor.

Augmenting Space-Filling Designs

You can progressively augment Halton and Sobol sequence space-filling designs to add points with the same sequence parameters. The following

method allows you to add points to your original space-filling sequence, preserving the original points and adding new ones with the same sequence parameters.

To augment a space-filling design without losing existing points or space-filling properties:

- 1 Create a Halton or Sobol sequence space-filling design.

Warning If you want to add constraints, you must first create a child design and constrain that. If you do not create a child design, when you add constraints you lose the original space-filling settings and then you cannot augment the sequence. With constraints, the design type changes to **Custom** and you cannot access the original sequence settings to add new points.

- 2 To preserve your original design when you add new points, create a child design of your original unconstrained design. Select your design, and click the New Design  button in the toolbar, or select **File > New**.

The new child design, identical to the parent, is selected in the tree.

- 3 Select **File > Properties**.

The Design Properties dialog box opens.

- 4 Select the **Space-Filling** tab.

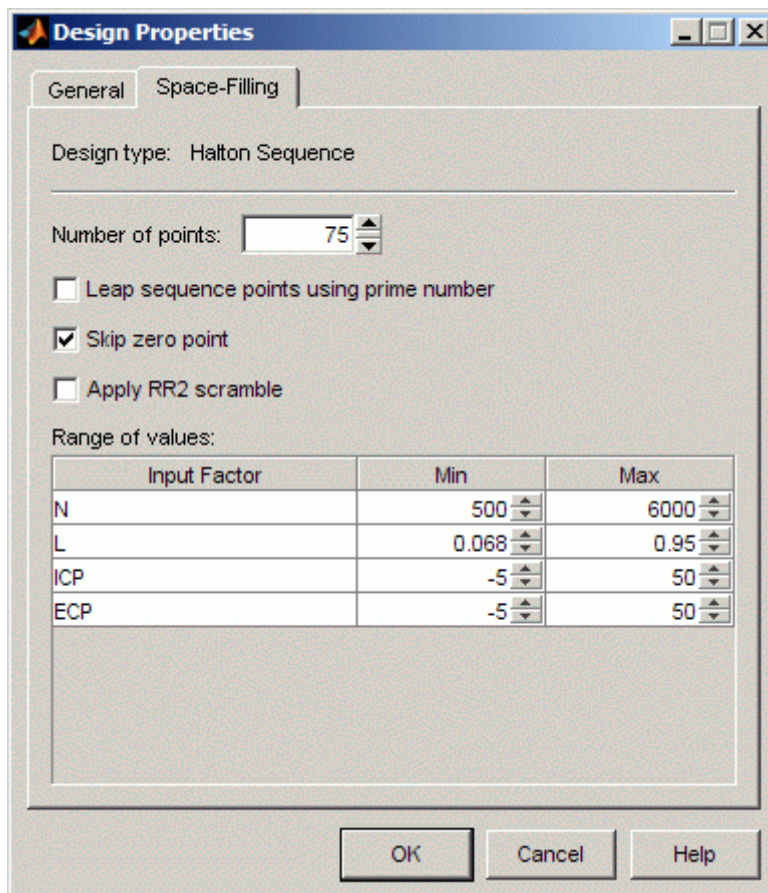

- 5 Enter the desired new total number of points in the **Number of points** edit box.

Leave the other settings unchanged.

- 6 Click **OK**.

The Design Editor augments your original design by adding points up to the new total number of points, with the same space-filling sequence parameters as your original Halton or Sobol sequence.

- 7 Use the pairwise view, switching between the parent and child designs to visually verify that the new points have been added while preserving your original points.
- 8 Create a copy child design to add constraints. Preserving your unconstrained parent design allows you to perform another augmentation iteration later if you need to.
- 9 New points are added to the end of the list of existing points. If you want to extract only the augmented points for testing, select **Edit > Delete Point** to open a dialog box in which you can choose the points to delete. See “Fixing, Deleting, and Sorting Design Points” on page 3-47.
- 10 Round and sort your data before sending it out for testing. Select **Edit > Round Factor** to limit decimal places of factors. Select **Edit > Sort** to sort the points for test efficiency, because operators often test in order of speed followed by load. See “Edit Menu” on page 3-11 and “Fixing, Deleting, and Sorting Design Points” on page 3-47.

Augmentation Restrictions

You can only augment Halton and Sobol sequence space-filling designs with this method that uses the original sequence settings.

You can augment any Halton sequence, but for Sobol sequences, you must use the default **No skip** setting.

You cannot achieve the same result by selecting any **Design > Space Filling** menu option and selecting the **Augment** option, because doing so will keep your existing points, but will generate the additional points with a new space-filling sequence.

You cannot augment a constrained design in this way. When you add constraints, the design type changes to **Custom**. You can no longer access the original sequence settings on the **Space-Filling** tab. If you want to add constraints, you must create a child design and constrain it. This approach preserves the original space-filling sequence design.

You cannot use this method with Latin Hypercube or Lattice designs as they always create a completely new design.

You cannot achieve the same result by using the Add Design Points dialog box because that dialog box only allows you to add optimal, custom, or random points.

Creating an Optimal Design

In this section...

“Introducing Optimal Designs” on page 3-31

“Optimal Design: Initial Design Tab” on page 3-33



“Optimal Design: Candidate Set Tab” on page 3-35

“Optimal Design: Algorithm Tab” on page 3-38

“Averaging Optimality Across Multiple Models” on page 3-40

Introducing Optimal Designs

Optimal designs are best for cases with high system knowledge, where previous studies have given confidence on the best type of model to be fitted, and the constraints of the system are well understood. Optimal designs require linear models.

- 1 Click the  button in the toolbar or select **File > New Design**. A new node appears in the design tree. It is named according to the model for which you are designing, for example, **Linear Model Design**.
- 2 Select the node in the tree by clicking. An empty Design Table appears if you have not yet chosen a design. Otherwise, if this is a new child node the display remains the same, because child nodes inherit all the parent design's properties.
- 3 Set up any constraints at this point. See “Applying Constraints” on page 3-51.
- 4 Choose an Optimal design by clicking the  button in the toolbar, or choose **Design > Optimal**.

The optimal designs in the Design Editor are formed using the following process:

- An initial starting design is chosen at random from a set of defined candidate points.

- p additional points are added to the design, either optimally or at random. These points are chosen from the candidate set.
- p points are deleted from the design, either optimally or at random.
- If the resulting design is better than the original, it is kept.

This process is repeated until either (a) the maximum number of iterations is exceeded or (b) a certain number of iterations has occurred without an appreciable change in the optimality value for the design.

The Optimal Design dialog box consists of three tabs that contain the settings for three main aspects of the design:

- **Initial Design** tab: Starting point and number of points in the design
- **Candidate Set** tab: Candidate set of points from which the design points are chosen
- **Algorithm** tab: Options for the algorithm that is used to generate the points

Optimal Design: Initial Design Tab

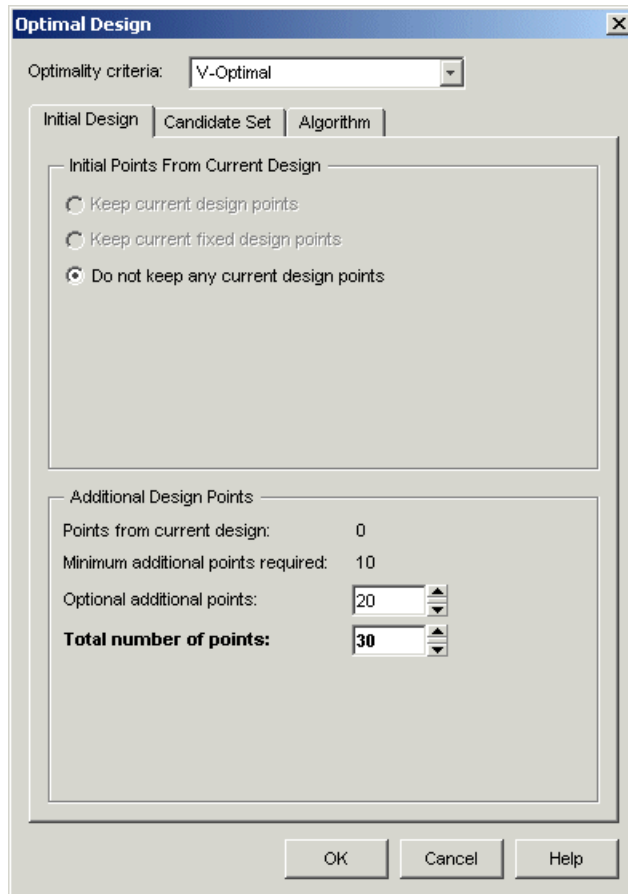

The **Initial Design** tab allows you to define the composition of the initial design: how many points to keep from the current design and how many total or additional points to choose from the candidate set.

- 1 Choose the type of the optimal design, using the **Optimality criteria** drop-down menu:
 - D-Optimal designs — Aims to reduce the volume of the confidence ellipsoid to obtain accurate coefficients. This is set up as a maximization problem, so the progress graph should go up with time.

The D-optimality value used is calculated using the formula

$$D_{\text{eff}} = \frac{\log_e(\det(\mathbf{XX}))}{k} \quad \text{where } X \text{ is the regression matrix and } k \text{ is the number of terms in the regression matrix.}$$

- **V-Optimal designs** — Minimizes the average prediction error variance, to obtain accurate predictions. This is better for calibration modeling problems. This is a minimization process, so the progress graph should go down with time.

The V-optimality value is calculated using the formula

$$V_{\text{eff}} = \frac{1}{n_c} \sum_j x_j' (\mathbf{X}_c' \mathbf{X}_c)^{-1} x_j$$

where x_j are rows in the regression matrix, \mathbf{X}_c is the regression matrix for all candidate set points, and n_c is the number of candidate set points.

- **A-Optimal designs** — Minimizes the average variance of the parameters and reduces the asphericity of the confidence ellipsoid. The progress graph also goes down with this style of optimal design.

The A-optimality value is calculated using the formula

$$A_{\text{eff}} = \text{trace}((\mathbf{XX})^{-1})$$

where X is the regression matrix.

- 2 You might already have points in the design (if the new design node is a child node, it inherits all the properties of the parent design). If so, choose from the radio buttons:

- **Replace the current points with a new initial design**
- **Augment the current design with additional points**
- **Keep only the fixed points from the current design**

For information on fixed design points, see “Fixing, Deleting, and Sorting Design Points” on page 3-47.

- 3** You can choose the total number of points and/or the number of additional points to add by clicking the **up/down** buttons or by typing directly into the edit boxes for **Optional additional points** or **Total number of points**.

Optimal Design: Candidate Set Tab

The **Candidate Set** tab allows you to set up a candidate set of points for your optimal design. Candidate sets are a set of potential test points. This typically ranges from a few hundred points to several hundred thousand.

The image shows the Optimal Design software interface. On the left, there are two windows: 'Set' and 'Candidate Set'. The 'Set' window displays a design space plot with a color scale for ICP (Inscribed Circle Packing) ranging from 3.16 to 46.13. The 'Candidate Set' window shows a grid of blue points. The main window is the 'Optimal Design' dialog box, which has tabs for 'Initial Design', 'Candidate Set', and 'Algorithm'. The 'Algorithm' tab is selected, showing the 'Generation algorithm' set to 'Grid'. There are options for 'Allow replicated points in design' and 'Options'. The 'Options' section has two radio buttons: 'Equally spaced levels' (selected) and 'User-specified levels'. Under 'Equally spaced levels', there are input fields for 'Minimum N value' (500), 'Maximum N value' (6000), and 'Number of levels for N' (21). A text box below shows '500:275:6000'. At the bottom, there are 'Display' icons and a 'Display a maximum of 2500 points' option. A note at the bottom says '1 constraint will be applied to this candidate set.' Buttons for 'OK', 'Cancel', and 'Help' are at the bottom right.

Select variables in this list

Choose algorithm type from this list

Optimality criteria: V-Optimal

Initial Design Candidate Set Algorithm

Generation algorithm: Grid

Allow replicated points in design

Options

Equally spaced levels

Minimum N value: 500

Maximum N value: 6000

Number of levels for N: 21

User-specified levels

500:275:6000

Display

Display a maximum of 2500 points

1 constraint will be applied to this candidate set.

OK Cancel Help

Open display windows with these buttons

Change the number of levels of the selected variable here

The set generation schemes are as follows:

- **Grid** — Full factorial grids of points, with fully customizable levels.
- **Grid/Lattice** — A hybrid set where the main factors are used to generate a lattice, which is then replicated over a small number of levels for the remaining factors.
- **Halton Sequence** — Halton Sequence designs are generated from the `haltonset` class in the Statistics Toolbox software. See “Halton Sequence” on page 3-21 for more information
- **Lattice** — These have the same definition as the space-filling design lattices, but are typically used with about 10,000 points. The advantage of a lattice is that the number of points does not increase as the number of factors increases; however, you do have to try different prime number generators to achieve a good lattice. See “Lattice” on page 3-24.
- **Sobol Sequence** — Sobol sequence designs are generated from the `sobolset` class in the Statistics Toolbox software. See “Sobol Sequence” on page 3-22 for more information.
- **Stratified Lattice** — Another method of using a lattice when some factors cannot be set to arbitrary values. Stratified lattices ensure that the required number of levels is present for the chosen factor. Note that you cannot set more than one factor to stratify to the same N levels. This is because forcing the same number of levels would also force the factors to have the same generator. As for a lattice space-filling design, no two factors can have the same generator, because in such cases the lattice points all fall on the main diagonal of that particular pairwise projection, creating highly visible planes in the points and poor coverage of the space. For illustrations of this effect, see “Lattice” on page 3-24.
- **User-defined** — Import custom matrices of points from MATLAB software or MAT-files.

For each factor you can define the range and number of different levels within that range to select points.

- 1 Choose a type of generation algorithm from the drop-down menu. Note that you could choose different parameters for different factors (within an overall scheme such as **Grid**).

- 2** This tab also has buttons for creating plots of the candidate sets. Try them to preview your candidate set settings. If you have created a custom candidate set you can check it here. The edit box sets the maximum number of points that will be plotted in the preview windows. Candidate sets with many factors can quickly become very large, and attempting to display the entire set will take too long. If the candidate set has more points than you set as a maximum, only every Nth point is displayed, where N is chosen such that (a) the total displayed is less than the maximum and (b) N is prime. If you think that the candidate set preview is not displaying an adequate representation of your settings, try increasing the maximum number of points displayed.
- 3** Notice that you can see 1-D, 2-D, 3-D, and 4-D displays (fourth factor is color) all at the same time as they appear in separate windows (see the example following). Move the display windows (click and drag the title bars) so you can see them while changing the number of levels for the different factors.
- 4** You can change the factor ranges and the number of levels using the edit boxes or buttons.

Optimal Design: Algorithm Tab

The **Algorithm** tab has the following algorithm details:

- **Augmentation method** — Random or Optimal— Optimal can be very slow (searches the entire candidate set for points) but converges using fewer iterations. Random is much faster per iteration, but requires a larger number of iterations. The Random setting does also have the ability to lower the optimal criteria further when the Optimal setting has found a local minimum.
- **Deletion method** — Random or Optimal— Optimal deletion is much faster than augmentation, because only the design points are searched.
- **p — number of points to alter per iteration** — The number of points added/removed per iteration. For optimal augmentation this is best kept smaller (~5); for optimal deletion only it is best to set it larger.
- **Delta — value below which the change in optimality criteria triggers an increment in q** — This is the size of change below which changes in the optimality criteria are considered to be not significant.

- **q — number of consecutive non-productive iterations which trigger a stop** — Number of consecutive iterations to allow that do not increase the optimality of the design. This only has an effect if random augmentation or deletion is chosen.
- **Maximum number of iterations to perform** — Overall maximum number of iterations.

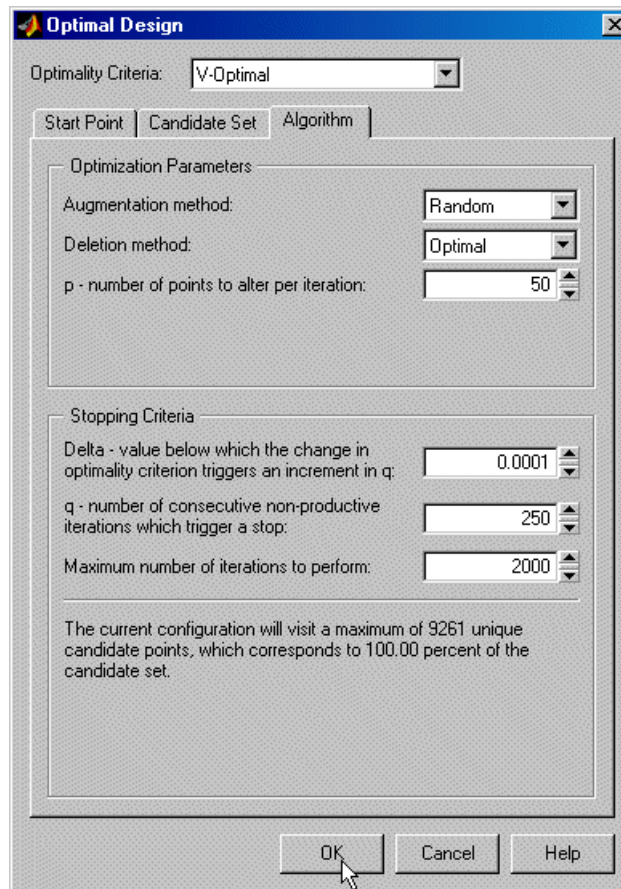

- 1 Choose the augmentation and deletion methods from the drop-down menus (or leave at the defaults).

- 2** You can alter the other parameters by using the buttons or typing directly in the edit boxes.
- 3** Click **OK** to start optimizing the design.

When you click the **OK** button on the Optimal Design dialog box, another window appears that contains a graph. This window shows the progress of the optimization and has two buttons: **Accept** and **Cancel**. **Accept** stops the optimization early and takes the current design from it. **Cancel** stops the optimization and reverts to the original design.

- 4** You can click **Accept** at any time, but it is most useful to wait until iterations are not producing noticeable improvements; that is, the graph becomes very flat.

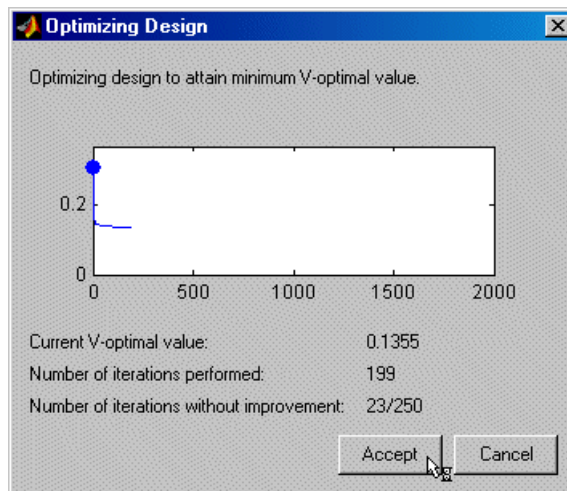

You can always return to the Optimal Design dialog box (following the same steps) and choose to keep the current points while adding more.

Averaging Optimality Across Multiple Models

The Design Editor can average optimality across several linear models. This is a flexible way to design experiments using optimal designs. If you have no idea what model you are going to fit, you would choose a space-filling design. However, if you have some idea what to expect, but are not sure which model

to use, you can specify a number of possible models. The Design Editor can average an optimal design across each model.

For example, if you expect a quadratic and cubic for three factors but are unsure about a third, you can specify several alternative polynomials. You can change the weighting of each model as you want (for example, 0.5 each for two models you think equally likely). This weighting is then taken into account in the optimization process in the Design Editor. See “Global Model Class: Multiple Linear Models” on page 5-80.

Adding and Editing Design Points

In this section...

“Adding Design Points” on page 3-42

“Editing Design Points” on page 3-44

Adding Design Points

In any design, you can add points using the **Edit** menu. You can specify how many points to add and how to do so: optimally, randomly, or at specified values.

Note To add points with space-filling properties, see “Augmenting Space-Filling Designs” on page 3-26.

To add optimal, custom, or random points:

- 1 Select **Edit > Add Point** or click the  button. A dialog box appears, as shown following.
- 2 Choose an augmentation method from the drop-down menu: optimal (D,V, or A), random, or user-specified.

Note You can add points optimally to any design based on a linear or multilinear model, as long as it has the minimum number of points required to fit that model. This means that after adding a constraint you might remove so many points that a subsequent replace operation does not allow optimal addition.

- 3 Choose the number of points to add, using the buttons or typing into the edit box. For user-specified custom points, you also enter the values of each factor for each point you want to add.

- 4 If you choose an optimal augmentation method and click **Edit**, the Candidate Set dialog box appears, as shown in the following example. Here you can edit the ranges and levels of each factor and which generation algorithm to use. These are the same controls you see on the Candidate Set tab of the Optimal Design dialog box.

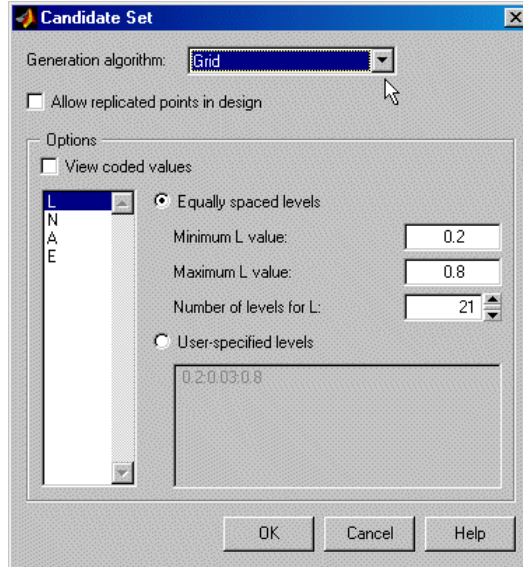

- 5 Click **OK** to add the points and return to the main display.

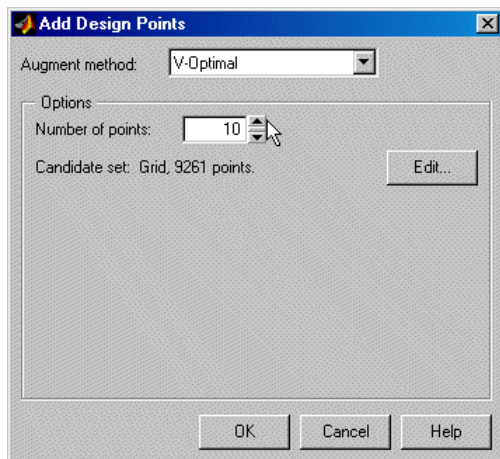

Editing Design Points

To edit particular points,

- 1 Right-click the title bar of one of the Design Editor views and select **Current View > Design Table** to change to the Table view. This gives a numbered list of every point in the design, so you can see where points are in the design.
- 2 To edit points, click to select table cells and type new values. You can also right-click table cells and select **Copy** or **Paste**. You can click and drag to select multiple cells to copy or paste.

Merging Designs

You can merge the points from two or more designs together using the **File** menu. You can merge designs together to form a new design, or merge points into one of the chosen designs. Points that are merged retain their fixed status in the new design.

- 1 Select **File > Merge Designs**. A dialog box appears, as shown.

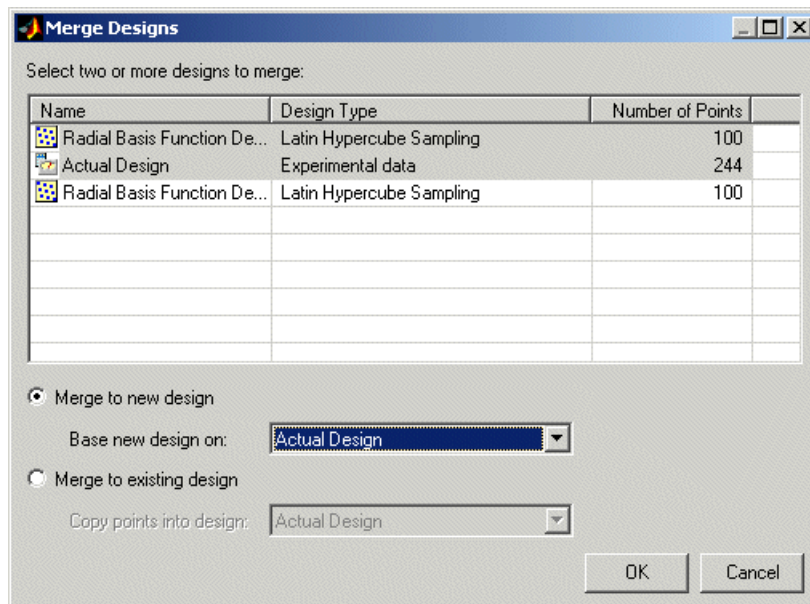

- 2 A list of all the designs from the Design Editor is shown, along with the associated design style and number of points. Select two or more designs from the list by dragging with the mouse or **Ctrl**+clicking.
- 3 When at least two designs have been selected, the options at the bottom of the dialog box are enabled. Choose whether you want to create a new design or put the design points into an existing design.
- 4 If you choose to create a new design, you must also choose one of the selected designs to act as a base. Properties such as the model, constraints, and any optimal design setup are copied from this base design. If you choose to reuse

an existing design you must choose one of the selected designs to receive the points from other designs.

- 5 Click **OK** to perform the merging process and return to the main display. If you choose to create a new design, it appears at the end of the design tree.

Fixing, Deleting, and Sorting Design Points

You can fix or delete points using the **Edit** menu. You can also sort points or clear all points from the design.

Fixed points become red in the main Design Editor table display. If you have matched data to a design or used experimental data as design points, those points are automatically fixed. You already have the data points, so you do not want them to be changed or deleted. Design points that have been matched to collected data are also fixed. Since these points have already been run they cannot be freed — you will not see them in the Fix Design Points dialog box. Once you have fixed points, they are not moved by design optimization processes. This automatic fixing makes it easy for you to optimally augment the fixed design points.

To fix or delete points:

- 1** To delete all points in the current design, select **Edit > Clear**.
- 2** If you want to fix or delete particular points, first change a Design Editor display pane to the Table view. This gives a numbered list of every point in the design, so you can see where points are in the design.
- 3** Select **Edit > Fix/Free Points** or **Edit > Delete Point** (or click the toolbar button ).
- 4** A dialog box appears in which you can choose the points to fix or delete.

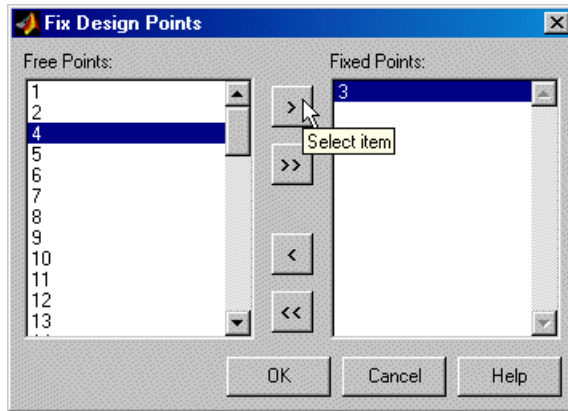

The example above shows the dialog box for fixing or freeing points. The dialog box for deleting points has the same controls for moving points between the **Keep Points** list and the **Delete Points** list.

- 5** Move points from the **Free Points** list to the **Fixed Points** list; or from the **Keep Points** list to the **Delete Points** list, by using the buttons.
- 6** Click **OK** to complete the changes specified in the list boxes, or click **Cancel** to return to the unchanged design.

To sort points:

- 1** Select **Edit > Sort**. A dialog box appears (see example following) for sorting the current design — by ascending or descending factor values, randomly, or by a custom expression.

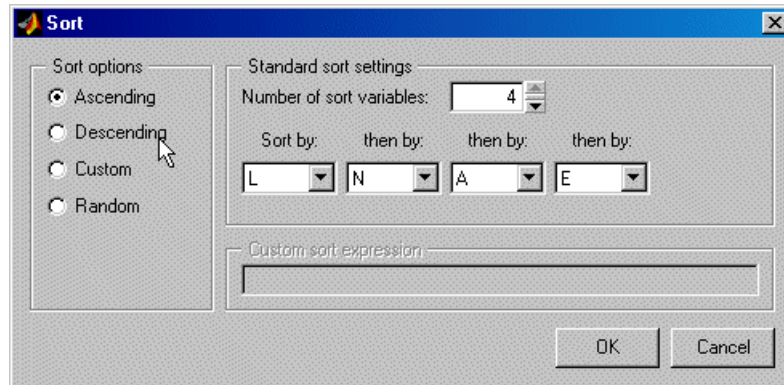

- 2** To sort by custom expression you can use MATLAB expressions (such as `abs(N)` for the absolute value of `N`) using the input symbols. Note that sorts are made using coded units (from -1 to 1) so remember that points in the center of your design space will be near zero in coded units, and those near the edge will tend to 1 or -1.
- 3** Select **Edit > Randomize** as a quick way of randomly resorting the points in the current design. This is a shortcut to the same functionality provided by the **Random** option in the Sort dialog box.

Exporting and Importing Designs

Note that you do not need to save your designs separately from the project. When you select **File > Close** you do not lose your designs, you simply close the Design Editor. When you save your project in the Model Browser, your designs remain part of that project. You can also export designs to a file or the workspace.

You can export any design by choosing **File > Export Design**. The selected design *only* is exported.

There are three options:

- **Design Editor file (*.mvd)** generates a Design Editor file (.mvd).
- **Comma separated format file (*.csv)** exports the matrix of design points to a CSV (comma-separated-values) file. You can include factor symbols by selecting the check boxes.
- **Workspace** exports the design matrix to the workspace. You can convert design points to a range of (1, -1) by selecting the check box.

You can choose the destination file or variable by typing in the edit box or using the browse button.

Import designs by selecting **File > Import**. The controls on the dialog box are very similar to the Export Design dialog box: you can import from Design Editor files, CSV files, or the workspace, and you can convert design points from a (1,-1) range.

Applying Constraints

In this section...
“How to Apply Constraints” on page 3-51
“Constraint Types” on page 3-54
“Importing Constraints” on page 3-60

How to Apply Constraints

In many cases designs might not coincide with the operating region of the system to be tested. For example, an automobile engine normally does not operate in a region of low speed (n) and high exhaust gas recirculation (EGR). You cannot run 15% EGR at 1000 RPM. There is no point selecting design points in impractical regions, so you can constrain the candidate set for test point generation.

Designs can have any number of geometric constraints placed upon them. Each constraint can be one of four types: an ellipsoid, a hyperplane, a 1-D lookup table, or a 2-D lookup table.

Note When you add constraints, the design type changes to **Custom** (except optimal designs). For space-filling and classical designs you can no longer access the original design generation settings in the Design Properties dialog box. If you want to preserve your original design settings, create a child design to constrain. This is important if you want to augment a space-filling design. See “Augmenting Space-Filling Designs” on page 3-26.

To add a constraint to a design:

- 1 Select **Edit > Constraints** from the Design Editor menus.
- 2 The Constraints Manager dialog box appears.

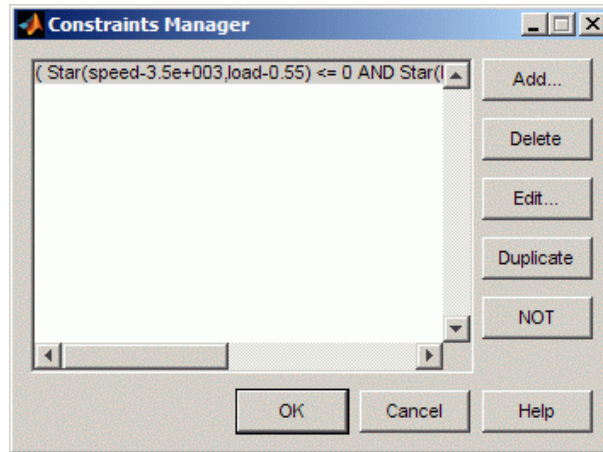

The example shows the Constraints Manager dialog box. Here you can add new constraints, and you can delete, edit, duplicate or negate existing constraints. Use the **NOT** button to negate a constraint, for example if you want to constrain points to be *outside* a boundary model.

If there are no constraints yet, the Constraints Manager is empty and you can only click **Add** to construct a new constraint.

To construct a new constraint,

- 1** Click **Add**.
- 2** The Constraint Editor dialog box with available constraints appears. You can select the following from the **Constraint Type** drop-down menu: Linear, Ellipsoid, 1-D Table and 2-Table. See the next section, “Constraint Types” on page 3-54.
- 3** After defining any constraint, click **OK**. Your new constraint appears in the Constraint Manager list box. Click **OK** to return to the Design Editor, or **Add** to define more constraints.

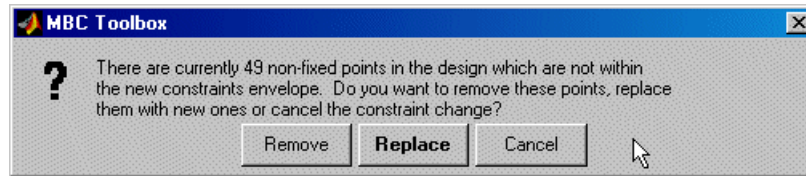

A dialog box appears if there are points in the design that fall outside your newly constrained candidate set. You can simply continue (delete them) or cancel the constraint. Fixed points are *not* removed by this process. For optimal designs you can also replace them with new random points within the new candidate set, as shown in the preceding example figure.

Note You only get the **Replace** points option for optimal designs. If you want to replace points removed by constraints from other designs, you can always use **Edit > Add Point** to add points optimally, randomly, or at chosen places. However, if so many points have been removed by a constraint that there are not enough left to fit the current model, optimal addition is not possible. See “Adding and Editing Design Points” on page 3-42.

To view constraints in the Design Editor:

- 1 Right-click the Design Editor display pane to reach the context menu.
- 2 Select **Current > View > 3D Constraints**. (You can also select 2-D constraints view). See the following figure for an example.

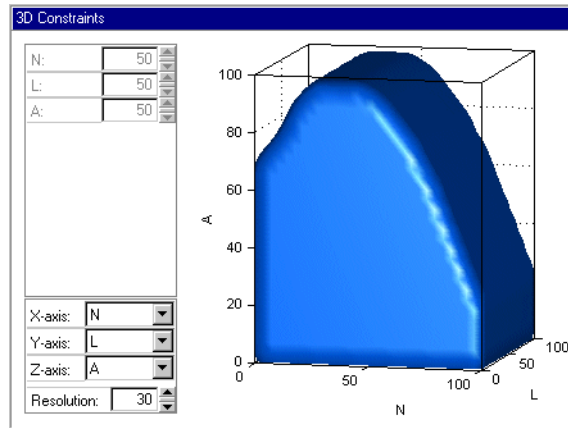

These views are intended to give some idea of the region of space that is currently available within the constraint boundaries.

Constraint Types

- “1-D Table Constraints” on page 3-54
- “2-D Table Constraints” on page 3-59
- “Linear Constraints” on page 3-56
- “Ellipsoid Constraints” on page 3-57

Note These constraint types are the same in the Design Editor and in optimizations in the CAGE Browser part of the Model-Based Calibration Toolbox product.

1-D Table Constraints

1-D table constraints limit the maximum or minimum setting of one factor as a function of another factor. Linear interpolation between user-defined points is used to specify the constraint. You can use the Table Editor tab or the Graphical Editor tab to define the constraint.

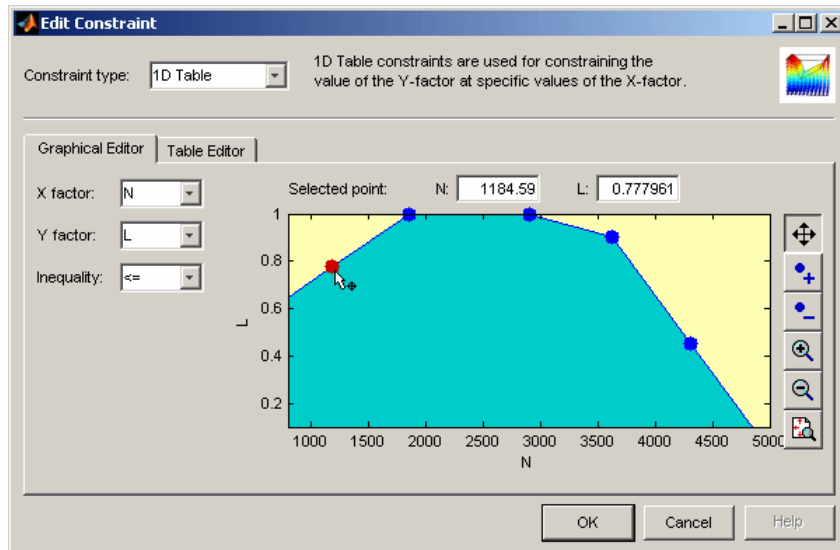
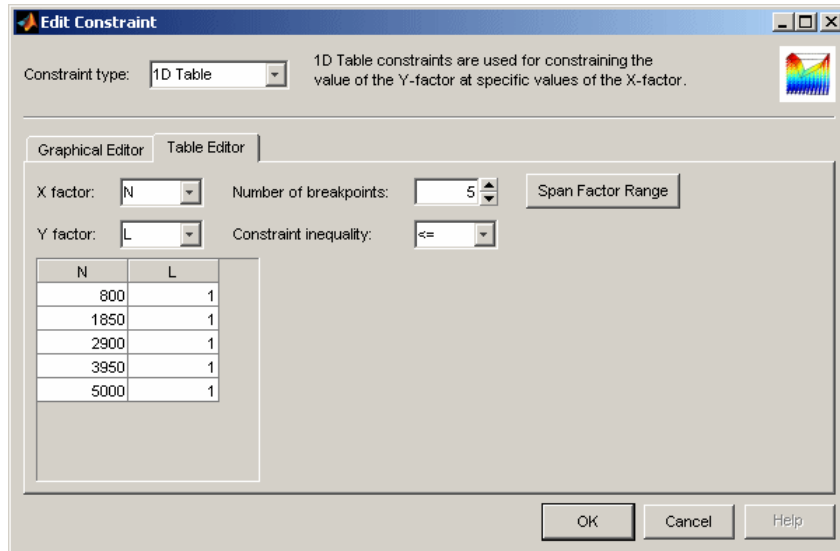

- On either tab, select the appropriate factors to use for X and Y, and choose whether to constrain above or below the defined boundary using the **Inequality** drop-down menu.

- On the **Table Editor** tab you can enter the number of breakpoints, click the button to **Span Factor Range** to space your breakpoints evenly, and you can enter breakpoint values into the table.
- On the **Graphical Editor** tab you can add and remove points, and click and drag the points to define the boundary. You can also enter values in the edit boxes for the selected point.

Linear Constraints

You specify the coefficients of the equation for an (N-1) dimensional hyperplane in the N-factor space. The form of the equation is $A \cdot x = b$ where A is your defined coefficient vector, x is the vector of values of the factor(s) to be constrained, and b is a scalar. For example,

In two dimensions: $A=(1, 2)$, $x=(L, A)$, $b=3$

Then $A \cdot x = b$ expands to

$$1 \cdot L + 2 \cdot A = 3$$

Rearranging this, you can write it as

$$A = -L/2 + 3/2$$

which corresponds to the traditional equation of a 2-D straight line, $y = mx + c$, with $m = -1/2$ and $c = 3/2$. $A \cdot x = b$ is thus the higher dimensional extension of this equation.

The linear constraints work by selecting the region below the defined plane (that is, $A \cdot x \leq b$). To select a region above the plane, multiply all your values by -1: $A \rightarrow -A$, $b \rightarrow -b$.

For example, to select a simple plane where $SPK < 50$ as a constraint boundary, enter 1 next to SPK and 50 next to b. You can set all the other factors to 0 (or you can remove them on the Inputs tab if you are constraining an optimization).

Ellipsoid Constraints

The ellipsoid constraint allows you to define an N-dimensional ellipsoid. You can specify the center of the ellipsoid, the length of each axis, and the rotation of the ellipsoid.

Ellipsoid center. You can specify the center of the ellipsoid by entering values in the **Center point** columns. These are the values, in natural units, that mark where you want the ellipsoid to be centered in each of the factor dimensions. The defaults are the midpoint of each factor range.

Axis length. You specify the size of the ellipsoid by entering values along the diagonal of the matrix. The default values create an ellipsoid that touches the edge of the space in each of the factor dimensions. In general, for an entry value X in the diagonal, the ellipsoid size in that factor is $1/\sqrt{X}$.

If you want a radius of r in a factor, enter $1/(r^2)$. For example, if you want to restrict N to a radius of 2000 from the center point, enter $1/2000^2 = 2.5e-7$, as shown in the example below.

Enter a zero in the diagonal to not constrain with respect to that factor.

Rotation. The matrix entries that are not on the main diagonal control rotation of the ellipsoid.

The following example shows a defined ellipsoid constraint.

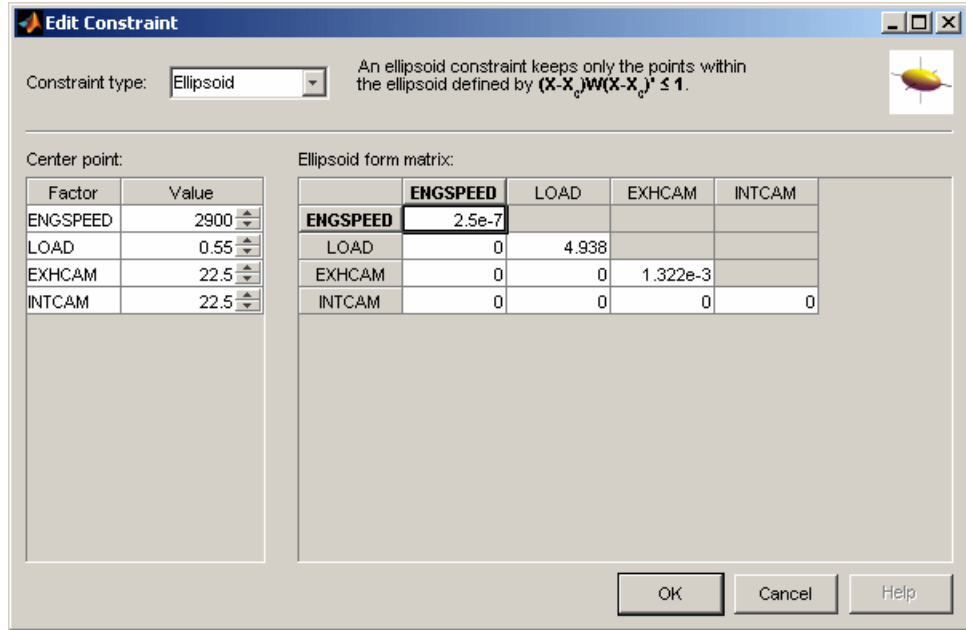

You must enter values in the table to define the ellipsoid. If you leave the values at the defaults, the candidate set is a sphere.

In this example, entering 2.5e-7 in the ENGSPPEED diagonal restricts that axis to $1/\sqrt{2.5e-7} = 2000$. Entering zero in the INTCAM diagonal leaves INTCAM unconstrained (that is, the constraint is a cylinder extending to the ends of the INTCAM factor range). The ellipse is not rotated as the non-diagonal matrix entries are all zero.

A 3-D display to show the shape of this example constraint in the Design Editor can be seen below.

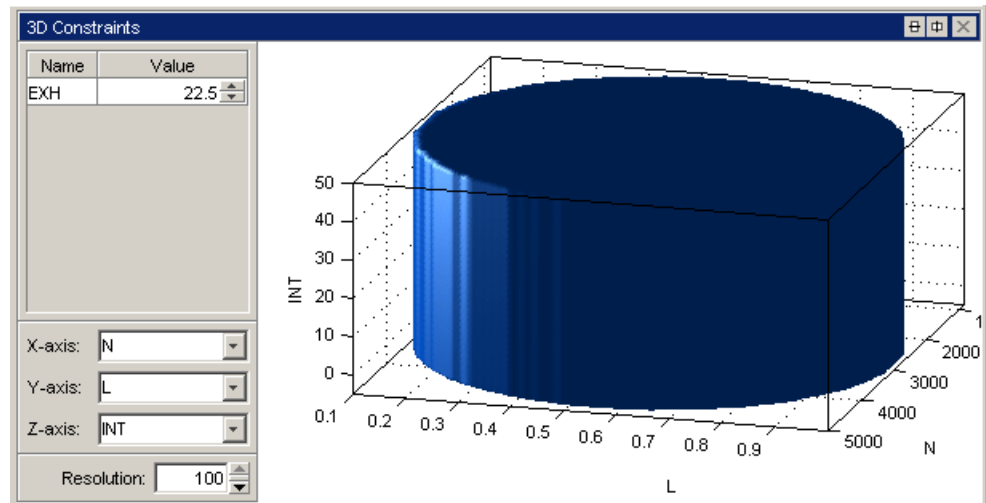

2-D Table Constraints

2-D table constraints are an extension of the 1-D table. Constraint boundary values for a factor are specified over a 2-D grid of two other factors.

- You can specify these grid locations by entering values in the top row and left column, while the matrix of values for the third factor is entered in the rest of the edit boxes. To specify grid values, you can enter values directly or just choose the number of breakpoints for your grid and space them over the factors' ranges, using the controls described below.
- You can specify the number of breakpoints for the X and Y factors.
- You can click **Span Range** to space your breakpoints evenly over the range of X or Y. This is useful if you add some breakpoints, as new points are often all at the maximum value for that factor. It is much quicker to use the **Span Range** button than to change points manually.
- You can specify to keep the region below (\leq) or above (\geq) the constraint boundary, as for the 1-D table, using the **Inequality** drop-down menu for the Z factor.

- You can switch to coded values using the check box. See the example.

The constraint boundary between the defined grid points is calculated using bilinear interpolation.

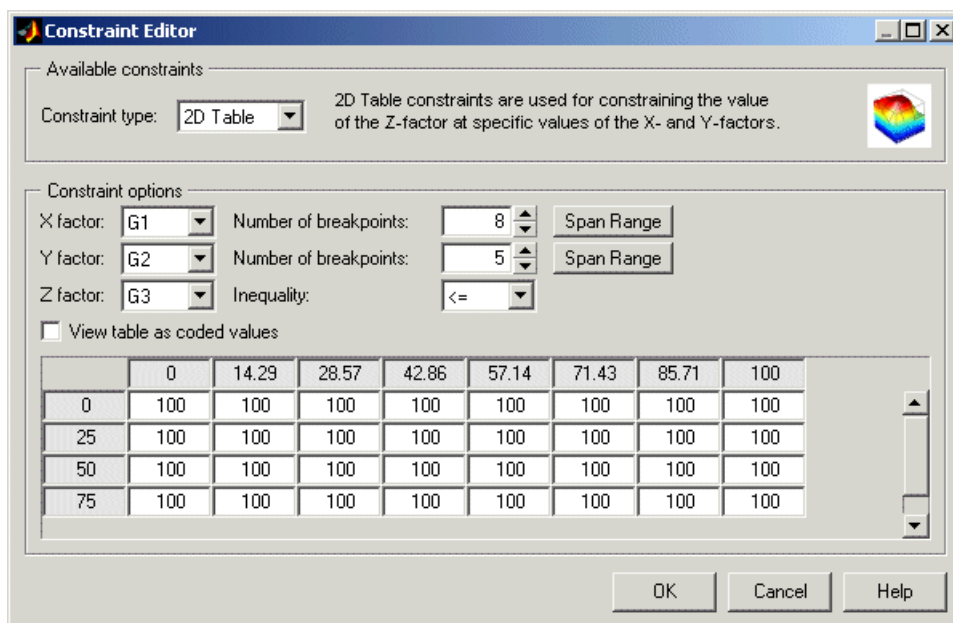

See also “1-D Table Constraints” on page 3-54

Importing Constraints

Select **File > Import Constraints**. The Import Constraints dialog box appears, as shown in the following example.

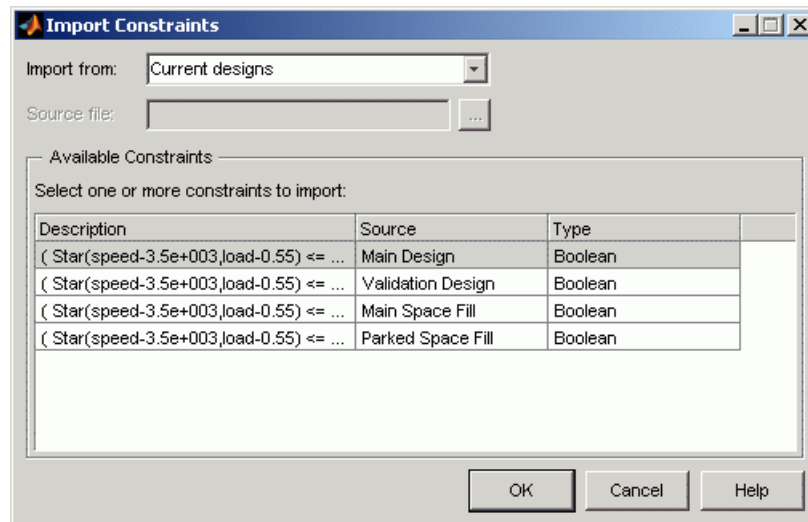

Here you can import constraints for the currently selected design from

- Current designs — import any existing constraints in the design tree
- Design editor file (*.mvd) — extract constraints from a design file
- Boundary constraints (current project) — import boundary constraints from the Model Browser project
- Boundary constraints (*.mat file) — extract boundary constraints from file

Note You can only import design constraints from designs that have the same number of factors and have the same coded range for each factor. For designs of N factors you can import boundary constraints with N or less active factors.

- 1 If importing from a file you can type the filename in the edit box or use the **browse** button to locate the file.
- 2 Click to select constraints in the **Available Constraints** list, or **Ctrl+click** to select multiple constraints.
- 3 Click **OK** to import and apply the constraints.

If importing boundary constraints a dialog box appears (once for each constraint) where you can match up factor names.

Prediction Error Variance Viewer

In this section...

“Introducing the Prediction Error Variance Viewer” on page 3-63

“Display Options” on page 3-65

“Prediction Error Variance” on page 3-66

“Prediction Error Variance for Two-Stage Models” on page 3-68

Introducing the Prediction Error Variance Viewer

You can use the Prediction Error Variance (PEV) viewer to examine the quality of the model predictions. You can examine the properties of designs or global models. When you open it from the Design Editor, you can see how well the underlying model predicts over the design region. When you open it from a global model, you can view how well the current global model predicts. A low PEV (tending to zero) means that good predictions are obtained at that point.

The Prediction Error Variance Viewer is only available for linear models and radial basis functions.

When designs are rank deficient, the Prediction Error Variance Viewer appears but is empty; that is, the PEV values cannot be evaluated because there are not enough points to fit the model.

- From the Design Editor, select **Tools > Prediction Error Variance Viewer**.
- From the global level of the Model Browser, if the selected global model is linear or a radial basis function,
 - Click the  toolbar button to open the Prediction Error Variance Viewer.
 - Alternatively, select **Model > Utilities > Prediction Error Variance Viewer**.

If a model has child nodes you can only select the Prediction Error Variance Viewer from the child models.

Turn PEV value clipping on and off here

Change PEV clipping value here

Prediction Error Variance Viewer
File View Window Help

Input factors:

N	Min: 800	Max: 5000	Pts: 21
L	Min: 0.1	Max: 1	Pts: 21
EXH			22.5
INT			22.5

Clip plot Clipping envelope: 2

Apply constraints

Apply boundary model

Display type:

- 2-D plot
- Surface
- Contour plot
- Movie

Optimality criteria

Criteria	Value	Location of G value:

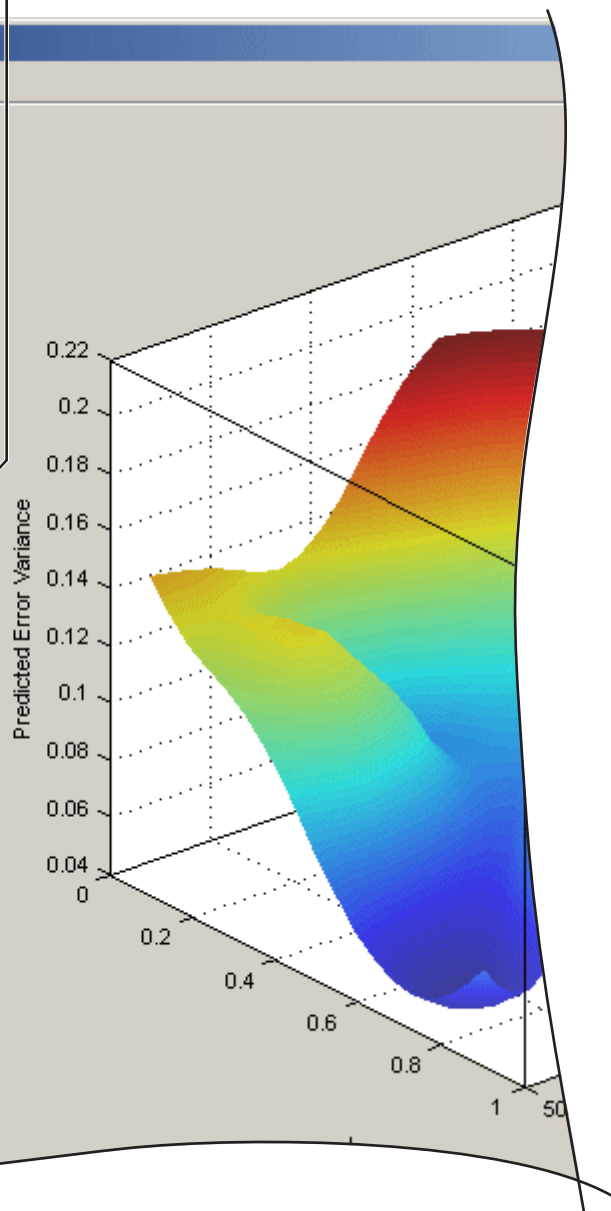

Apply boundary model clipping here

Apply design constraint clipping here

The default view is a 3-D plot of the PEV surface.

The plot shows where the model predictions are best. The model predicts well where the PEV values are lowest.

If you have transformed the output data (eg using a Box-Cox transform), then the Prediction Error Variance Viewer displays the predicted variance of the transformed model.

Display Options

- The **View** menu has many options to change the look of the plots.
- You can change the factors displayed in the 2-D and 3-D plots. The drop-down menus below the plot select the factors, while the unselected factors are held constant. You can change the values of the unselected factors using the buttons or edit boxes in the frame, top left.
- The **Movie** option shows a sequence of surface plots as a third input factor's value is changed. You can change the factors, replay, and change the frame rate.
- You can change the number, position, and color of the contours on the contour plot with the **Contours** button. See the contour plot section (in "Response Surface View" on page 6-51) for a description of the controls.
- You can select the **Clip Plot** check box, as shown in the preceding example. Areas that move above the PEV value in the **Clipping envelope** edit box are removed. You can enter the value for the clipping envelope. If you do not select **Clip Plot**, a white contour line is shown on the plot where the PEV values pass through the clipping value.
- You can also clip with the boundary model or design constraints if available. Select the check boxes **Apply constraint** or **Apply boundary model** to clip the plot.

When you use the Prediction Error Variance Viewer to see design properties, optimality values for the design appear in the **Optimality criteria** frame.

Note that you can choose Prediction Error shading in the Response Feature view (in Model Selection or Model Evaluation). This shades the model surface according to Prediction Error values ($\sqrt{\text{PEV}}$). This is not the same as the

Prediction Error Variance Viewer, which shows the shape of a surface defined by the PEV values. See “Response Surface View” on page 6-51.

Optimality Criteria

No optimality values appear in the **Optimality criteria** frame until you click **Calculate**. Clicking **Calculate** opens the Optimality Calculations dialog box. Here iterations of the optimization process are displayed.

In the **Optimality criteria** frame in the Prediction Error Variance Viewer are listed the D, V, G and A optimality criteria values, and the values of the input factors at the point of maximum PEV (**Location of G value**). This is the point where the model has its maximum PEV value, which is the G-optimality criteria. The D, V and A values are functions of the entire design space and do not have a corresponding point.

For statistical information about how PEV is calculated, see the next section “Prediction Error Variance” on page 3-66.

Prediction Error Variance

Prediction Error Variance (PEV) is a very useful way to investigate the predictive capability of your model. It gives a measure of the precision of a model’s predictions.

You can examine PEV for designs and for models. It is useful to remember that:

$$\text{PEV (model)} = \text{PEV (design)} * \text{MSE}$$

So the accuracy of your model’s predictions is dependent on the design PEV and the mean square errors in the data. You should try to make PEV for your design as low as possible, as it is multiplied by the error on your model to give the overall PEV for your model. A low PEV (close to zero) means that good predictions are obtained at that point.

You can think of the design PEV as multiplying the errors in the data. If the design PEV < 1, then the errors are reduced by the model fitting process. If design PEV > 1, then any errors in the data measurements are multiplied.

Overall the predictive power of the model will be more accurate if PEV is closer to zero.

You start with the regression (or design) matrix, for example, for a quadratic in N (engine speed) and L (load or relative air charge):

$$\mathbf{X} = \begin{bmatrix} 1 & L_1 & N_1 & L_1^2 & L_1 N_1 & N_1^2 \\ 1 & L_2 & N_2 & L_2^2 & L_2 N_2 & N_2^2 \\ \dots & \dots & \dots & \dots & \dots & \dots \\ 1 & L_n & N_n & L_n^2 & L_n N_n & N_n^2 \end{bmatrix}$$

If you knew the actual model, you would know the actual model coefficients β . In this case the observations would be:

$$y = \mathbf{X}\beta + \varepsilon$$

where ε is the measurement error with variance

$$\text{var}(\varepsilon) = \text{MSE}$$

However you can only ever know the predicted coefficients:

$$\hat{\beta} = (\mathbf{X}^T \mathbf{X})^{-1} \mathbf{X}^T y$$

which have variance

$$\text{var}\hat{\beta} = (\mathbf{X}^T \mathbf{X})^{-1} \text{MSE}$$

Let x be the regression matrix for some new point where you want to evaluate the model, for example:

$$x = \begin{bmatrix} 1 & L_{new} & N_{new} & L_{new}^2 & L_{new} N_{new} & N_{new}^2 \end{bmatrix}$$

Then the model prediction for this point is:

$$\hat{y} = x\hat{\beta} = x(X^T X)^{-1} X^T y$$

Now you can calculate PEV as follows:

$$\text{PEV}(x) = \text{var}(\hat{y}) = (x(X^T X)^{-1} X^T)(X(X^T X)^{-1} X^T) \text{MSE}$$

$$\text{PEV}(x) = x(X^T X)^{-1} x^T \text{MSE}$$

Note the only dependence on the observed values is in the variance (MSE) of the measurement error. You can look at the PEV(x) for a design (without MSE, as you don't yet have any observations) and see what effect it will have on the measurement error - if it is greater than 1 it will magnify the error, and the closer it is to 0 the more it will reduce the error.

You can examine PEV for designs or global models using the Prediction Error Variance viewer. When you open it from the Design Editor, you can see how well the underlying model predicts over the design region. When you open it from a global model, you can view how well the current global model predicts. A low PEV (tending to zero) means that good predictions are obtained at that point. See "Prediction Error Variance Viewer" on page 3-63.

For information on the calculation of PEV for two-stage models, see "Prediction Error Variance for Two-Stage Models" on page 3-68.

Prediction Error Variance for Two-Stage Models

It is very useful to evaluate a measure of the precision of the model's predictions. You can do this by looking at Prediction Error Variance (PEV). Prediction error variance will tend to grow rapidly in areas outside the original design space. The following section describes how PEV is calculated for two-stage models.

For linear global models applying the variance operator to Equation 6-15 yields:

$$\text{Var}(\beta) = (Z^T W^{-1} Z)^{-1} Z^T W^{-1} \text{Var}(P) W^{-1} Z (Z^T W^{-1} Z)^{-1} \quad \text{so}$$

$$\text{Var}(\beta) = (Z^T W^{-1} Z)^{-1} \quad (3-1)$$

since $\text{Var}(P) = W$. Assume that it is required to calculate both the response features and their associated prediction error variance for the i^{th} test. the predicted response features are given by:

$$\hat{\mathbf{p}}_i = \mathbf{z}_i \hat{\beta} \quad (3-2)$$

where \mathbf{z}_i is an appropriate global covariate matrix. Applying the variance operator to Equation 3-2 yields:

$$\text{Var}(\hat{\mathbf{p}}_i) = \mathbf{z}_i \text{Var}(\hat{\beta}) \mathbf{z}_i^T = \mathbf{z}_i (Z^T W^{-1} Z)^{-1} \mathbf{z}_i^T \quad (3-3)$$

In general, the response features are non-linear functions of the local fit coefficients. Let \mathbf{g} denote the non-linear function mapping θ_i onto \mathbf{P}_i . Similarly let \mathbf{h} denote the inverse mapping.

$$\hat{\theta}_i = \mathbf{h}(\hat{\mathbf{p}}_i) \quad (3-4)$$

Approximating \mathbf{h} using a first order Taylor series expanded about \mathbf{P}_i (the true and unknown fixed population value) and after applying the variance operator to the result:

$$\text{Var}(\hat{\theta}_i) = \dot{\mathbf{h}} \text{Var}(\hat{\mathbf{p}}_i) \dot{\mathbf{h}}^T \quad (3-5)$$

where the dot notation denotes the Jacobian matrix with respect to the response features, \mathbf{P}_i . This implies that $\dot{\mathbf{h}}$ is of dimension $(p \times p)$. Finally the predicted response values are calculated from:

$$\hat{\mathbf{y}}_i = \mathbf{f}(\hat{\theta}_i) \quad (3-6)$$

Again, after approximating \mathbf{f} by a first order Taylor series and applying the variance operator to the result:

$$\text{Var}(\hat{\mathbf{y}}_i) = \left[\frac{\partial \mathbf{f}}{\partial \theta} \right]_{\hat{\theta}} \dot{\mathbf{h}} \text{Var}(\hat{\mathbf{p}}_i) \dot{\mathbf{h}}^T \left[\frac{\partial \mathbf{f}}{\partial \theta} \right]_{\hat{\theta}}^T \quad (3-7)$$

After substituting Equation 3-3 into Equation 3-7 the desired result is obtained:

$$\text{Var}(\hat{y}_i) = \left[\frac{\partial f}{\partial \theta} \right]_{\hat{\theta}} h_{z_i} (Z^T W^{-1} Z)^{-1} z_i^T h \left[\frac{\partial f}{\partial \theta} \right]_{\hat{\theta}}^T \quad (3-8)$$

This equation gives the value of Prediction Error Variance.

Design Evaluation Tool

In this section...

“Introducing the Design Evaluation Tool” on page 3-71

“Table Options” on page 3-73

“Design Matrix” on page 3-73

“Full FX Matrix” on page 3-74

“Model Terms” on page 3-74

“Z2 Matrix” on page 3-74

“Alias Matrix” on page 3-74

“Z2.1 Matrix” on page 3-75

“Regression Matrix” on page 3-75

“Coefficient Information” on page 3-75

“Standard Error” on page 3-77

“Hat Matrix” on page 3-78

“|XX|” on page 3-78

“Raw Residual Statistic” on page 3-79

“Degrees of Freedom Table” on page 3-79

“Design Evaluation Graphical Displays” on page 3-80

“Export of Design Evaluation Information” on page 3-81

Introducing the Design Evaluation Tool

The Design Evaluation tool is only available for linear models.

You can open the Design Evaluation tool from the Design Editor or from the Model Browser windows. From the Design Editor select **Tools > Evaluate Designs** and choose the design you want to evaluate. From the Model

Browser global view, you can click the  button.

Design Evaluation Tool - [Design]

File View Design Options Window Help

	L	N	A	E
1	-0.999	-1.000	-1.016	-0.027
2	-0.993	-1.000	1.017	-0.998
3	-0.328	-1.000	-0.982	-1.000
4	-0.433	-1.000	0.202	0.724
5	-0.352	-0.600	-0.356	0.796
6	0.241	-1.000	1.027	-0.089
7	-1.003	-0.801	-0.302	-1.000
8	-0.662	-0.800	0.100	0.786
9	0.299	-0.800	-0.355	0.001
10	0.638	-0.800	0.336	-0.969
11	-1.002	-0.600	-1.035	0.872
12	-0.969	-0.600	0.353	-0.046
13	-0.380	-0.600	-0.325	0.905
14	-0.344	-0.600	1.037	-1.000
15	0.292	-0.599	-1.013	-1.000
16	0.280	-0.600	0.999	0.723
17	1.072	-0.600	-0.965	-0.988
18	-1.007	-0.200	-0.321	-1.000
19	-0.924	-0.201	1.051	-0.153

Design matrix
Full FX matrix
Model terms
 Z_2 matrix
Alias matrix
 $Z_{2,1}$ matrix
Regression matrix
Coefficient information
Standard error
Hat matrix
 $|X'X|$
Raw residual statistics

Coded Units Natural Units

Export
 Export to workspace
 Export to mat file...
 Variable name:

 Export

Degrees of Freedom Table

Source	D.O.F.
Model	34
Residual	16
Replication	0
Lack of fit	16
Total	50

Current Matrix Information
 Rank: 4
 Condition: 1.5358
 Xc : design/actual factor test points matrix for the experiment, in coded units.

No colormap enabled. No filter enabled.

In the Design Evaluation tool you can view all the information on correlations, covariance, confounding, and variance inflation factors (VIFs). You can investigate the effects of including or excluding model terms aided by this information (you must remove them in the Stepwise window). Interpretation is aided by color-coded values based on the magnitude of the numbers. You can specify changes to these criteria.

When you open the Design Evaluation tool, the default view is a table, as shown in the preceding example. You choose the elements to display from the list on the right. Click any of the items in the list described below to

change the display. Some of the items have a choice of buttons that appear underneath the list box.

To see information about each display, click the  toolbar button or select **View > Matrix Information**.

Table Options

You can apply color maps and filters to any items in a table view, and change the precision of the display.

To apply a color map or edit an existing one:

- 1 Select **Options > Table > Colors**. The Table Colors dialog box appears.
- 2 Select the check box **Use a colormap for rendering matrix values**.
- 3 Click the **Define colormap** button. The Colormap Editor dialog box appears, where you can choose how many levels to color map, and the colors and values to use to define the levels. Some tables have default color maps to aid analysis of the information, described below.

You can also use the **Options > Table** menu to change the precision (number of significant figures displayed) and to apply filters that remove specific values or values above or below a specific value from the display.

The status bar at bottom left displays whether color maps and filters are active in the current view.

When evaluating several designs, you can switch between them with the **Next design** toolbar button or the **Design** menu.

Design Matrix

Xn/Xc: design/actual factor test points matrix for the experiment, in natural or coded units. You can toggle between natural and coded units with the buttons on the right.

Full FX Matrix

Full model matrix, showing all possible terms in the model. You can include and exclude terms from the model here, by clicking on the green column headings. When you click one to remove a term, the column heading becomes red and the whole column is grayed.

The Full FX matrix is the same as the Jacobian for linear models if all terms included. Jacobian only includes 'in' terms. In the general case, jacobian is expressed:

$$(i, j) = df/dp_j (x_i)$$

In the case of linear models and RBFs this simplifies to:

$$(i,j) = j^{\text{th}} \text{ term evaluated at } i^{\text{th}} \text{ data point} = \text{Jacobian matrix.}$$

Model Terms

You can select terms for inclusion in or exclusion from the model here by clicking. You can toggle the button for each term by clicking. This changes the button from in (green) to out (red) and vice versa. You can then view the effect of these changes in the other displays.

Note Removal of model terms only affects displays within the Design Evaluation tool. If you decide the proposed changes would be beneficial to your model, you must return to the Stepwise window and make the changes there to fit the new model.

Z₂ Matrix

Z₂: Matrix of terms that have been removed from the model. If you haven't removed any terms, the main display is blank apart from the message "All terms are currently included in the model."

Alias Matrix

Like the Z₂ matrix, the alias matrix also displays terms that are not included in the model (and is therefore not available if all terms are included in the

model). The purpose of the alias matrix is to show the pattern of confounding in the design.

A zero in a box indicates that the row term (currently included in the model) is not confounded with the column term (currently not in the model). A complete row of zeros indicates that the term in the model is not confounded with any of the terms excluded from the model. A column of zeros also indicates that the column term (currently not in the model) could be included (but at the cost of a reduction in the residual degrees of freedom).

A: the alias matrix is defined by the expression

$$A = (X'X)^{-1}X'Z_2$$

Z2.1 Matrix

As this matrix also uses the terms not included in the model, it is not available if all terms are included.

$Z_{2,1}$: Matrix defined by the expression $Z_{2,1} = Z_2 - XA$

Regression Matrix

Regression matrix. Consists of terms included in the model. $n \times p$ matrix where n is the number of test points in the design and p is the number of terms in the model.

Coefficient Information

When you select **Coefficient information**, six buttons appear below the list box. Covariance is displayed by default; click the buttons to select any of the others for display.

Covariance

Cov(b): variance-covariance matrix for the regression coefficient vector b .

$$Cov(b) = (X'X)^{-1}$$

Correlation

Corr(b): correlation matrix for the regression coefficient vector b.

$$\text{Corr}(b)_{ij} = \frac{\text{Cov}(b)_{ij}}{\sqrt{\text{Cov}(b)_{ii}}\sqrt{\text{Cov}(b)_{jj}}}$$

By default **Correlation** has an active color map to aid analysis. Values below -0.9 are red, -0.9 to -0.7 are orange, -0.7 to 0.707 are black, 0.707 to 0.9 are orange, and greater than 0.9 are red. You can view and edit the color map using **Options > Table > Colors**.

Partial VIFs

Variance Inflation Factors (VIFs) are a measure of the nonorthogonality of the design with respect to the selected model. A fully orthogonal design has all VIFs equal to unity.

The Partial VIFs are calculated from the off-diagonal elements of Corr(b) as

$$\text{VIF}_{ij} = \frac{1}{(1 - \text{Corr}(b)_{ij}^2)} \text{ for } p \geq i > j > 1$$

Partial VIFs also has a default color map active (<1.2 black, >1.2<1.4 orange, >1.4 red). A filter is also applied, removing all values within 0.1 of 1. In regular designs such as Box-Behnken, many of the elements are exactly 1 and so need not be displayed; this plus the color coding makes it easier for you to see the important VIF values. You can always edit or remove color maps and filters.

Multiple VIFs

Measure of the nonorthogonality of the design. The Multiple VIFs are defined as the diagonal elements of Corr(b):

$$\text{VIF}_i = \{\text{Corr}(b)^{-1}\}_{ii}$$

Multiple VIFs also has a default color map active (<8 black, 8><10 orange, >10 red). A filter is also applied, removing all values within 0.1 of 1. Once again this makes it easier to see values of interest.

2 Column Corr.

Corr(X); correlation for two columns of X.

$$w_{ij} = \frac{x_{ij} - \bar{x}_j}{\sqrt{\sum_{i=1}^N (x_{ij} - \bar{x}_j)^2}}$$

Let W denote the matrix of w_{ij} values. Then the correlation matrix for the columns of X (excluding column 1) is Corr(X), defined as

$$\text{Corr}(X) = W'W$$

2 Column Correlation has the same default color map active as **Correlation**.

Single Term VIFs

Measure of the nonorthogonality of the design. The Single Term VIFs are defined as

$$VIF_{ij} = \frac{1}{(1 - \text{Corr}(X)_{ij}^2)} \text{ for } p \geq i > j > 1$$

Single term VIFs have a default color map active (<2 black, 2>red) and values within 0.1 of 1 are filtered out, to highlight values of interest.

Standard Error

σ_j : Standard error of the j^{th} coefficient relative to the RMSE.

Hat Matrix

Full Hat matrix

H: The Hat matrix.

$$H = QQ'$$

where Q results from a QR decomposition of X. Q is an $n \times n$ orthonormal matrix and R is an $n \times p$ matrix.

Leverage values

The leverage values are the terms on the leading diagonal of H (the Hat matrix). Leverage values have a color map active (<0.8 black, 0.8>orange<0.9, >0.9 red).

|X'X|

D; determinant of X'X.

D can be calculated from the QR decomposition of X as follows:

$$D = \left[\prod_{i=1}^p (R_{1,ii}) \right]^2$$

where p is the number of terms in the currently selected model.

This can be displayed in three forms:

$$|X'X|$$

$$\log(|X'X|)$$

$$|X'X|^{(1/p)}$$

Raw Residual Statistic

Covariance

Cov(e): Variance-covariance matrix for the residuals.

$$\text{Cov}(e) = (I - H)$$

Correlation

Corr(e) : Correlation matrix for the residuals.

$$\text{Corr}(e)_{ij} = \frac{\text{Cov}(e)_{ij}}{\sqrt{(\text{Cov}(e)_{ii})} \sqrt{(\text{Cov}(e)_{jj})}}$$

Degrees of Freedom Table

To see the Degrees of Freedom table (and the information about each display), click the  toolbar button or select **View > Matrix Information**.

Source	D.O.F.
Model	5
Residual	14
Replication	0
Lack of fit	14
Total	19

Source	D.F.
Model	p
Residual	n-p
Replication	by calculation
Lack of fit	by calculation
Total	n

Replication is defined as follows:

Let there be n_j (>1) replications at the j^{th} replicated point. Then the degrees of freedom for replication are

$$\sum_j (n_j - 1)$$

and Lack of fit is given by $n - p$ - degrees of freedom for replication.

Note: replication exists where two rows of X are identical. In regular designs the factor levels are clearly spaced and the concept of replication is unambiguous. However, in some situations spacing can be less clear, so a tolerance is imposed of 0.005 (coded units) in all factors. Points must fall within this tolerance to be considered replicated.

Design Evaluation Graphical Displays

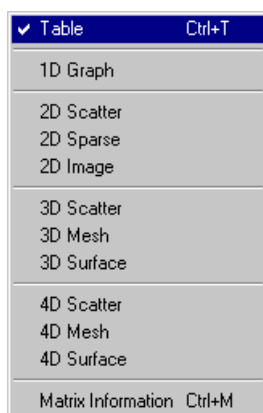

The Design Evaluation tool has options for 1-D, 2-D, 3-D, and 4-D displays. You can switch to these by clicking the toolbar buttons or using the **View** menu.

Which displays are available depends on the information category selected in the list box. For the Design matrix, (with sufficient inputs) all options are available. For the Model terms, there are no display options.

You can edit the properties of all displays using the **Options** menu. You can configure the grid lines and background colors. In the 2-D image display

you can click points in the image to see their values. All 3-D displays can be rotated as usual. You can edit all color map bars by double-clicking.

Export of Design Evaluation Information

All information displayed in the Design Evaluation tool can be exported to the workspace or to a .mat file using the radio buttons and **Export** button at the bottom right. You can enter a variable name in the edit box.

Data

This section discusses the following topics:

- “Using Data” on page 4-2
- “The Data Editor” on page 4-5
- “Data Loading and Merging” on page 4-18
- “Creating Variables” on page 4-24
- “Creating Filters” on page 4-27
- “Storage” on page 4-30
- “Test Groupings” on page 4-34
- “Data Selection Wizard” on page 4-37
- “Matching Data to Designs” on page 4-44
- “Data Loading Application Programming Interface” on page 4-52

Using Data

This section describes all aspects of loading, manipulating, and selecting data in the Model Browser. The Data Editor provides a powerful graphical interface for dealing with data:

- You use the Data Editor for loading, filtering, grouping, and editing data, and you can define new variables. You can match data to designs. You can reach the Data Editor from every node in the model tree, so you can also examine and export your modeling data. The Data Editor contains various graphical interfaces for these tasks:
 - Data Import Wizard for loading and merging data
 - Variable Editor, Filter Editor, Test Filter Editor, and Test Notes Editor are dialog boxes for creating and editing new variables and data filters.
 - Storage dialog box for storing new variables, data filters, and plot settings
 - Test Groupings dialog box can be used for plotting and manipulating data groups.
 - Within the Data Editor there are 2-D, 3-D, and multiple data plots for viewing data, and cluster plots for viewing data and design points.
 - You use the cluster plots views within the Data Editor for matching data to experimental designs. You can set tolerances for automatic selection of the nearest data points to the specified design points, or select data points manually.
- You use the Data Wizard to select data for modeling. You can also set up matching data to designs by setting tolerances and automatically opening the cluster plots views within the Data Editor. You reach the Data Wizard from test plan level.

You can load and merge data from the following:

- From files (Excel®, Concerto, MATLAB)
- From the workspace

See “Data Loading and Merging” on page 4-18.

You can also write your own data-loading functions. See “Data Loading Application Programming Interface” on page 4-52.

Within “The Data Editor” on page 4-5, you can do the following:

- View plots, edit and add data records. See “Data Editor Views” on page 4-7.
- Define new variables. See “Creating Variables” on page 4-24.
- Apply filters to remove unwanted records, filter by test, and apply notes to tests that fulfill set criteria. See “Creating Filters” on page 4-27.
- Store and retrieve user-defined variables and filters. See “Storage” on page 4-30.
- Define test groupings to collect data into groups.
- Match data to experimental designs using the cluster plots views.
- Export data and modeling output to file and to the workspace.

You use the Data Wizard to do the following:

- Select the data set and design to use for modeling.
- Select the data signals to use for model input factors (one-stage, or local and global for two-stage).
- Select matching tolerances (if matching data to a design).
- Select data signals for response model input factors.

There is a tutorial to guide you through using the Data Editor. See “Data Manipulation for Modeling” in the Getting Started documentation.

Tip for Fast Data Editor Access

When you open the Data Editor from the test plan level, a Cluster Plot is displayed. If you want to open the Data Editor frequently from the test plan level, it will save time if you previously had a Cluster Plot view open when you last used the Data Editor.

The Data Editor retains memory of the types of views open when you last used the Data Editor. If the previous views did not include a Cluster Plot view,

then when you open the Data Editor from the test plan level the existing views are saved and replaced with a Cluster Plot view and a Cluster Information list view. The views revert to the previous views when you close the Data Editor. This process takes longer to display than if you had an existing Cluster Plot view (the Cluster Information list view is not required).

The Data Editor

In this section...

“Introducing the Data Editor” on page 4-5

“Data Editor Views” on page 4-7

“Data Editor Toolbar and Menus” on page 4-14

Introducing the Data Editor

To reach the Data Editor,

- From the test plan node, choose **TestPlan > Select Data**.
- Alternatively, from the project node, do one of the following:
 - Choose **Data > New Data, Copy Data, or Edit Data**.
 - Select any of the equivalent toolbar buttons.
 - Double-click a data set in the **Data Sets** pane.
- From any modeling node, click the View Modeling Data toolbar button.

As can be seen in the following example, you can split the view to display several plots at once. As in the Design Editor, you use the right-click context menu to split the views, or use the toolbar buttons or the **View** menu.

You can choose 2-D plots, 3D plots, multiple data plots, data tables, and list views of filters, variables, test filters, and test notes.

See “Data Editor Views” on page 4-7 for details on the functions available in each type of view.

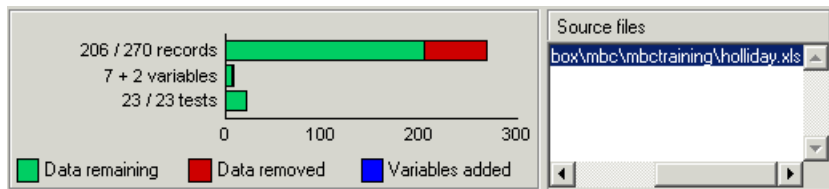
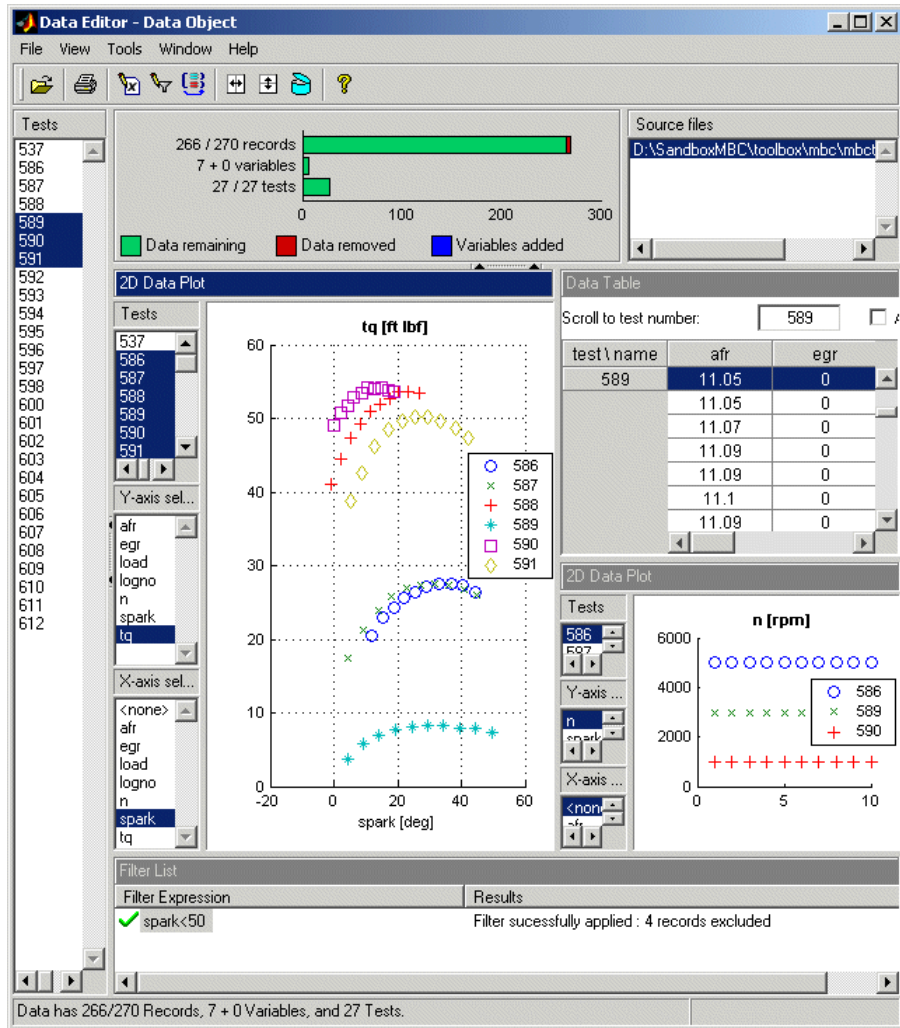

The list box at the top right contains the source file information for the data, and other information is displayed on the left: the numbers of records, variables, and tests it contains. See the preceding example. The bars and figures show the proportion of records removed by any filters applied, and the number of user-defined variables is shown. For this example with two user-defined variables added to a data set originally containing seven variables, you see '7 + 2 variables.'

The **Tests** list pane on the left is constant. Tests selected here apply to 3-D plots, multiple data plots, and tables. It does not apply to 2-D plots because they have their own independent test controls. If you are viewing read-only local modeling data, the selected test is shown in the **Tests** pane and remains synchronized if you change test in the Model Browser.

See "Data Editor Toolbar and Menus" on page 4-14 for other controls.

By default new data sets are called Data Object. You can change the names of data sets at the project node by select-clicking a data set in the **Data Sets** list, or by pressing **F2** (as when selecting to rename in Windows Explorer).

To edit data plot properties (2-D, 3-D, or multiple), you can right-click the plot and select **Viewer Options > Properties**. Here you can choose to show the legend and the grid. You can choose the line style if you want to connect the data points and the data marker point style, if any. **Reorder X Data** (2-D plots) redraws the line joining the points in order from left to right. The line might not make sense when drawn in the order of the records.

Note Dismissing the Data Editor automatically brings up the Data Wizard if you entered it from the test plan level.

Data Editor Views

You can open multiple different views at the same time in the Data Editor, as shown in the following example. You can display 2-D plots, 3-D plots, multiple data plots, cluster plots, data tables, and list views of your filters, variables, and test notes. Use the toolbar buttons, the **View** menu, or right-click a view title bar to split views and change view types.

Functions of different views are described in the following sections:

- “2-D Plots” on page 4-9
- “3-D Plots” on page 4-10
- “Multiple Data Plots” on page 4-10
- “Cluster Plots” on page 4-11
- “List Views — Variables, Filters, Test Filters, Test Notes, and Clusters” on page 4-12
- “Table View” on page 4-12
- “Notes View” on page 4-13

2-D Plots

In the 2-D plot view you can select combinations of variables and tests to plot from the list boxes on the left. Multiple selection of tests and y-axis variables is possible — as show in the following figure, multiple tests are selected to view several tests simultaneously.

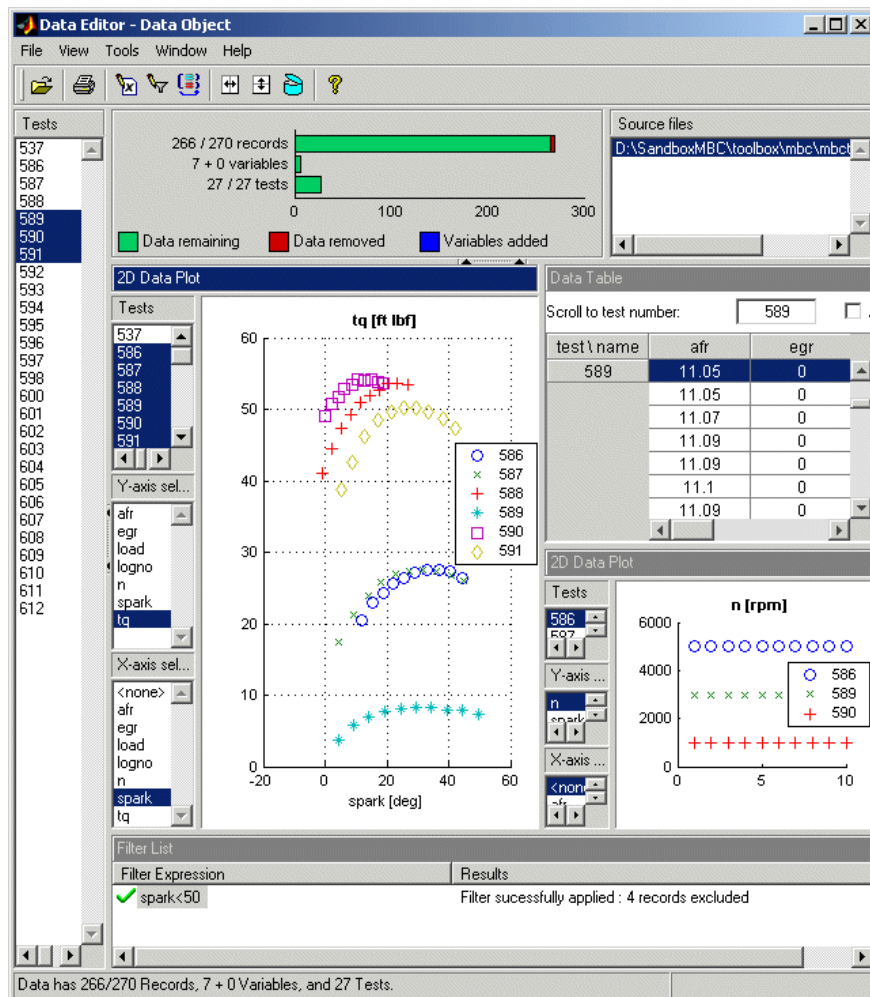

See “Data Editor Toolbar and Menus” on page 4-14. Note that you use the 2-D plot view controls for selecting the tests to display. This is unlike the other plots (3-D and multiple data plots), which you control by using the **Tests** list box, always visible on the left of the Data Editor.

To edit data plot properties, you can right-click the plot and select **Viewer Options > Properties**. Here you can choose to show the legend and the grid. You can choose the line style if you want to connect the data points and the data marker point style, if any. **Reorder X Data** redraws the line joining the points in order from left to right. The line might not make sense when drawn in the order of the records. You can use the **Show Bad Data** check box to plot bad data (that is, outliers you have removed).

Click points to select outliers, and remove them by selecting **Tools > Filters > Remove Outliers** (or use the keyboard shortcut **Ctrl+A**). Select **Tools > Filters > Restore Outliers** (or use the keyboard shortcut **Ctrl+Z**) to open a dialog box where you can choose to restore any or all removed points.

3-D Plots

In 3-D data plot views you can select the variables for each axis from the drop-down menus, and rotate the plot by clicking and dragging. To edit data plot properties, you can right-click the plot and select **Viewer Options > Properties**. Here you can choose the color and style of the axes, whether to show the grid in each axis, and perspective or orthographic axes projection.

Multiple Data Plots

Here you can add as many 2-D plots as desired to the same view, plotting the same selection of tests in a variety of different plots. Use the right-click context menu to add and remove plots, select plot variables, and edit plot properties. You can select single or multiple Y variables to plot against a single X variable (or no X variable) in the Plot Variables dialog box. Select tests to display in the list on the left of the Data Editor, as for 2-D and 3-D plots and the table view.

Note that you can select different plot properties and variables for each plot within the Multiple Data Plots view, as shown in the example following.

Click to select a plot (or right-click) before selecting **Viewer Options > Plot Variables** or **Plot Properties**. For each plot you can use the same plot properties options as for the single 2-D data plots. You can choose to show the legend and the grid. You can choose the line style if you want to connect the data points and the data marker point style, if any. **Reorder X Data** redraws the line joining the points in order from left to right. The line might not make sense when drawn in the order of the records. You can use the **Show Bad Data** check box to plot bad data (that is, outliers you have removed).

Click points to select outliers, and remove them by selecting **Tools > Filters > Remove Outliers** (or use the keyboard shortcut **Ctrl+A**). Selected outliers are outlined in red, as shown in the following example.

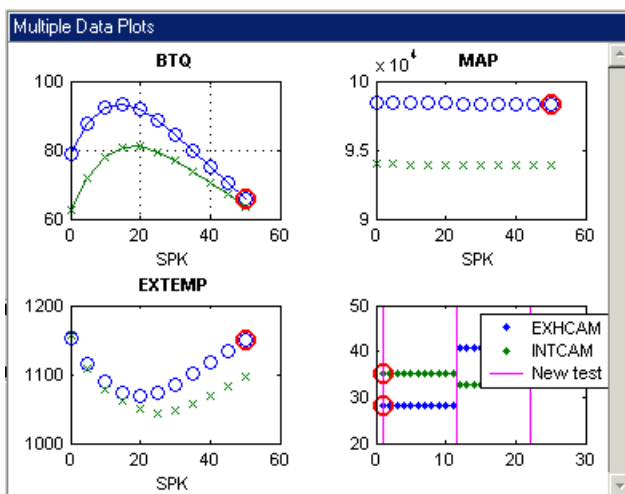

Select **Tools > Filters > Restore Outliers** (or use the keyboard shortcut **Ctrl+Z**) to open a dialog box where you can choose to restore any or all removed points.

Cluster Plots

You use these views for matching data to design points. Use the cluster information list view with the cluster view to examine your data and design. Click points in the cluster view to select them across the Data Editor — that is, the selected points are displayed in the table view and other data plot views (except 2-D plots, which have separate controls).

See “Matching Data to Designs” on page 4-44 for detailed information on cluster plot controls.

List Views – Variables, Filters, Test Filters, Test Notes, and Clusters

These views show lists and information such as variable and filter definitions, the notes applied to filtered tests, and the data and design points in selected clusters. Variable and Filter List views show the definitions of each variable or filter. Double-click to select particular filters or variables to edit. See “Creating Variables” on page 4-24 and “Creating Filters” on page 4-27.

The Test Notes List view shows the rules used to define notes on the data, along with the actual note, the color of the note, and the number of tests to which that note applies. The specified rule is applied to each test in turn to decide if that test should be noted: e.g., $\text{mean}(\text{TQ}) > 0$ evaluates the mean torque for each test and notes those tests where the value is greater than zero. The list of individual tests and notes appears in the “Notes View” on page 4-13.

In the Cluster List view you can choose to include or exclude design and data points by using the check boxes in cluster list views. See “Matching Data to Designs” on page 4-44 for more information on using these.

Table View

In the Table view, you can view your data, edit, and add records.

Points you have selected in plots (by clicking) are outlined in red in the table. Points you have removed as outliers are light red in the table with a filter icon next to the row number. Edited cells become blue.

Select **View > Viewer Options** or right-click the title bar to reach these options.

- **Duplicate Selected Records** — First select one or more records, then use this option to duplicate them. Each duplicate appears directly underneath the parent record. Edit duplicates to create new records. You must first select **Allow Editing** to enable this option.

- **Undo Edits in Selected Region** — You can click and drag to highlight a region, then use this option to reverse any edits in the highlighted area. You must first select **Allow Editing** to enable this option.
- **Allow Editing** — Toggles editing, and, as a side effect, causes all records to be shown, including those which are filtered out. Records which are filtered out appear light red in the table, with a filter icon next to the row number. You can alter records by clicking a cell and then typing a new value. Edited cells become blue. Editing the value of a cell may cause that row to be filtered out. If so, the background colour of the row will change after the cell has been edited.
- **Select Columns To Display** — Opens a dialog box where you can use the check boxes to select the columns to display in the table. Select a column, then press **Ctrl+A** to select all columns, and then you can select or clear all check boxes with one click. You can click and drag column headers in the table view to rearrange columns.

Notes View

This view shows a list of all tests in the data, along with those notes that apply to particular tests. Each note that applies to one or more tests has its own column in the view. You can sort the columns in the list by clicking the column header (once to sort ascending and once more to sort descending) allowing you to quickly identify the tests that satisfy a given note definition — this facility could be used to screen incoming data for problem tests.

You can click a particular test in the Notes view list to select that test across the Data Editor. Select a test in the Notes view, and that test is displayed in the table view, 3-D plot, and multiple data plots views (but not the 2-D plots, which have their own test selection controls). If you select multiple tests, they are all shown in the data plots, but only the first test in the list is highlighted in the Table view.

Data Editor Toolbar and Menus

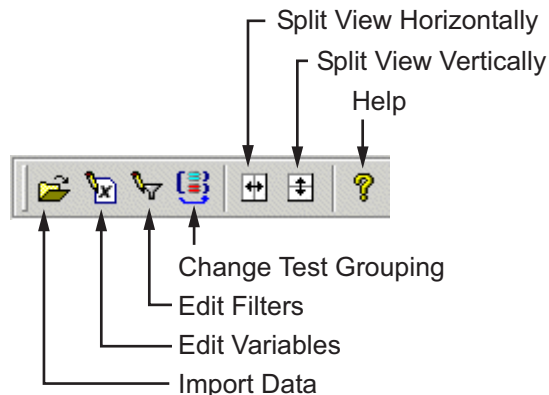

- Import Data — See “Loading Data from File” on page 4-18; also in the **File** menu.
- Edit Variables — Opens the Variable Editor.
- Edit Filters — Opens the Filter Editor.
- Change Test Grouping — Opens the Test Groupings dialog box; also in the **Tools** menu.
- Split View Horizontally — Divides the currently selected plot into two plots side by side. Also in the **View** menu.
- Split View Vertically — Divides the currently selected plot into two plots one above the other. Also in the **View** menu.
- Open Storage Window — Opens “Storage” on page 4-30 where you can store and retrieve variables, filters, and plot settings.

The **Window** and **Help** menus are the same as everywhere in the Model Browser. See “Window Menu” on page 2-10 and “Help Menu” on page 2-10.

File Menu

- **Import**
 - **File** — See “Loading Data from File” on page 4-18.
 - **Workspace** — See “Loading Data from the Workspace” on page 4-20.
 - **Excel** — Loads Excel files.
- **Export**
 - **Workspace** — Exports data to the workspace.
 - **Excel** — Exports data to an Excel file.
- **Print** — Prints your currently selected plot.
- **Close** — Closes the Data Editor.

View Menu

- **Current View**
 - Here you can choose from **2-D Data Plot**, **3-D Data Plot**, **Multiple Data Plots**, **Data Table**, **Variable Definitions**, **Filter Definitions**, **Test Filter Definitions**, and **Test Note Definitions**, **Notes View**, **Cluster View**, **Cluster Information**. A tick shows the type of view currently selected.
- **Viewer Options** — These change depending on the currently selected view, and are duplicated in the right-click menu in each view.
 - **Properties** — Only for data plots (2-D, 3-D, or multiple), not table or list views. Opens a properties dialog box for the current plot. Here you can change settings for grids, lines, markers, legends, and axes. For 2-D and multiple data plots you can choose whether to plot bad data (that is, outliers you have removed with the **Tools** menu).
 - Multiple data plot views have several specific options. You can select **Add Plot** to add another subplot to the current view, or **Remove All Plots** to clear the current view. For the selected subplot (right-click the plot, or click first and use the menu) you can select **Plot Variables** to set up axes or **Remove Plot** to delete.

- **Split View** — Divides the currently selected view and adds the selected option. You can choose from the same options available under **Current View**.
- **Split View Horizontally** — Divides the currently selected plot into two plots side by side. The new plot is a 1-D plot by default; you can select other views using the right-click context menu. Also in the toolbar.
- **Split View Vertically** — Divides the currently selected plot into two plots one above the other. Also in the toolbar.
- **Delete Current View** — Deletes the currently selected view.
- **Print to Figure** — Copies the currently selected view to a Figure window.

See Toolbar above.

Tools Menu

Note that if you are viewing modeling data in the Data Editor (from a modeling node) you cannot change the data, so editing and user-defined variables and filtering are not enabled; you cannot use the **Tools** menu to alter your modeling output.

- **Variables**
 - **Add** opens the Variable Editor. Here you can add new variables to the data set by typing into the edit box.
 - **Edit** is only enabled if you already have user-defined variables. This also opens the Variable Editor with an additional list on the left containing your defined variables. Select these from the list and edit in the edit box. You can also add new variables here by clicking the button to add a new item to the list.

The toolbar button Edit Variables performs the same functions.
- **Filters**
 - **Add** and **Edit** both open the Filter Editor, in a similar way to the variable items. Here you can remove records by imposing constraints on the data. Also in the toolbar.

- **Remove Outliers** — Removes points you have selected in plots (outlined in red). Use the check box to **Show Bad Data** (in the Plot Properties dialog box) to see removed points on plots.
- **Restore Outliers** — Opens a dialog box where you can choose any or all removed points to restore.
- **Test Filters** — **Add** and **Edit** both open the Test Filter Editor.
- **Test Notes** — **Add** and **Edit** both open the Test Note Editor.
- **Change Test Groupings** — Opens the Test Groupings dialog box; also in the toolbar.
- **Tolerances** — Opens the Tolerance Editor. These settings are for matching data to designs using the cluster views. See “The Tolerance Editor” on page 4-49.
- **Open Storage**— Opens Storage where you can store and retrieve variables, filters, and plot settings.

Data Loading and Merging

In this section...

“Introducing Data Loading” on page 4-18

“Loading Data from File” on page 4-18

“Loading Data from the Workspace” on page 4-20

“Tailor-Made Excel Sheets” on page 4-22

Introducing Data Loading

Data can be loaded and merged from files, from the workspace, and from tailor-made Excel sheets, as described in the following sections.

A test plan can only use a single data set, so if you want to use more than one source file, you need to use the merge functions to combine data variables in order to incorporate desired variables into one model.

Note that you can also write your own data-loading functions. See “Data Loading Application Programming Interface” on page 4-52. This includes a description of the correct structure for importing data from the workspace. This is the same structure of data as when you export to the workspace.

Loading Data from File

From the project node choose **Data > New Data**. The Data Editor appears.

- Click the Open File button in the toolbar  to load data from a file.
- Alternatively, choose **File > Import > File**.

The Data Import Wizard appears, to help you select a file.

Alternatively, from the test plan node,

- 1** Select **TestPlan > Select Data**. The Data Wizard appears.
- 2** Click **Load new data set** and the Data Import Wizard appears.

Note If you already have some data loaded, the Data Import Wizard can merge new data into the existing data set.

The Data Import Wizard

- 1 To import data from a file, enter the file pathname in the edit box, or use the Browse button to find and select the data file. Double-click to load the file.

The drop-down menu contains the file types recognized by the Model Browser (Excel, Delimited text files, MATLAB). The default Auto tries to determine the type of file by looking at the file extension. For text files, see “Text File Formats” on page 4-20.

- 2 For Excel files with multiple sheets, you must next select the sheet you want to use and click **OK**.
- 3 The Import Wizard now displays a summary screen showing the total number of records and variables imported, and you can view each variable’s range, mean, standard deviation, and units in the list box. You can edit variable names and units in this list. Click **Finish** to accept the data, unless you have data to merge. See “Merging Data” on page 4-19.

The Data Import Wizard disappears and the view returns to the Data Editor (or the Data Wizard if you are selecting data from a test plan — see “Data Selection Wizard” on page 4-37).

Merging Data

- 1 If you already have some data loaded, you cannot click **Finish** but must click **Next** instead. This brings you to the data merging screen of the wizard.
- 2 Here you must choose one of the radio buttons:
 - Merge extra channels (more variables)
 - Merge extra records (more data, same variables)
 - Overwrite old data (use only the new data)

- 3** Click **Next**. The wizard summary screen appears, showing the results of the merge. You can click **<Prev** to go back and change merging options.
- 4** Click **Finish** to accept the data and return to the Data Editor.

Note Obviously the merge might not succeed if the data sets do not contain the same variables. A message appears if the merge is impossible when you click **Next** and you must make another choice.

Text File Formats

Select **Delimited Text File** from the **Open As** list to read delimited text files into MBC. These files can be delimited by tabs, |, commas or spaces. They may optionally contain a variable name header and units header line.

Select **Delimited Text Sweep File** from the **Open As** list to read delimited text files with multiple blocks of data into MBC. These files can be delimited by tabs, |, commas or spaces. Each block of data may optionally contain a variable name header and units header line. The first block's names and headers are used, subsequent rows of non-numeric data are stripped out. The data can be split into multiple blocks where each block contains data for a separate sweep. Within each block, a column that consists of a value in the first row and empty values in the remaining rows for initial columns will be assumed as meaning that for these columns each row should take its value from the first row in the block. Note that the data is imported as a single array and you must use the Test Groupings window to decide how to sort the data into sweeps. See "Test Groupings" on page 4-34.

Loading Data from the Workspace

- 1** From the project node choose **Data > New Data**.

The Data Editor appears.

You can import variables from the MATLAB workspace by choosing **File > Import > Workspace**.

See "Data Editor Toolbar and Menus" on page 4-14.

The Loading Data from Workspace dialog box appears.

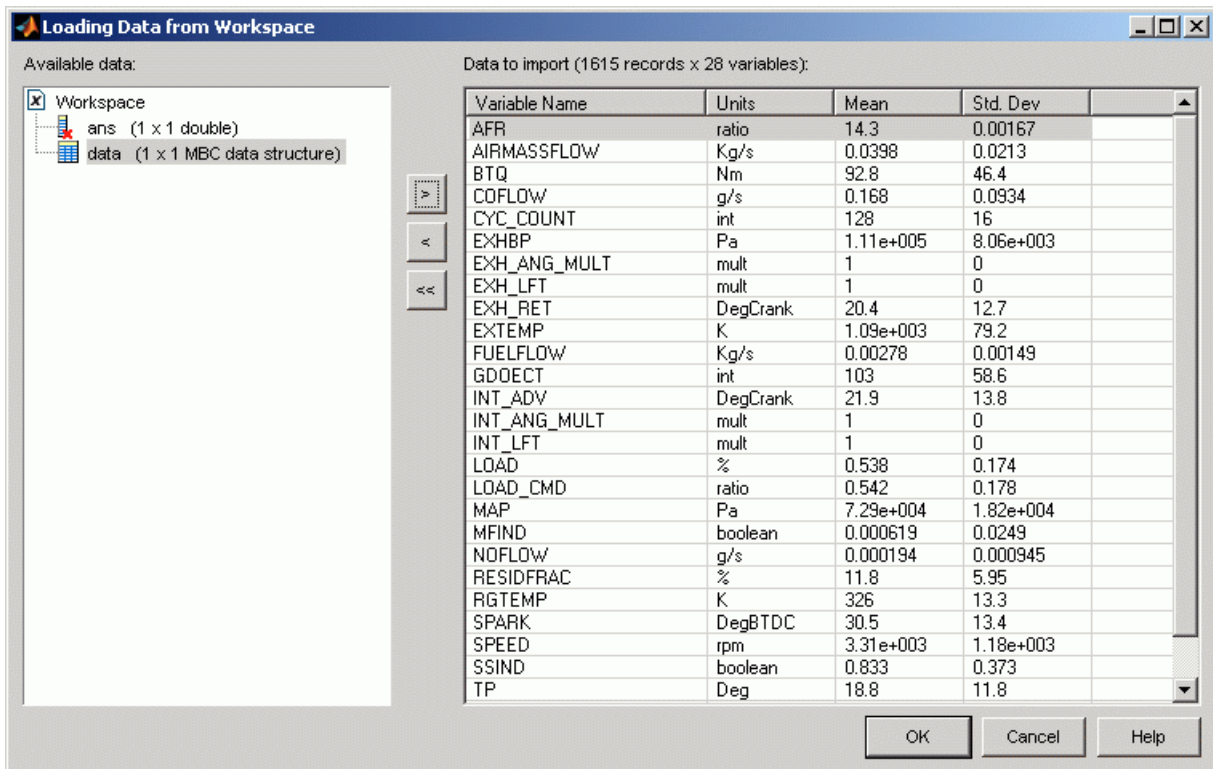

Variables in the workspace are displayed in hierarchical form in the top left pane.

- 1 Select a variable to import in the tree at top left.
- 2 Click the **Add** button.

The number of records and variables appears in the **Output Data** pane. You can add variables (one at a time) as many times as you like (as long as there are no name conflicts; suffixes “_1” are added to repeated names).

You can double click to edit variable names and units.

3 You can use the **Remove** button to remove selected variables one at a time from the right list, or click or **Remove all** to remove all variables at once.

4 Click **OK** to accept the data to import and return to the Data Editor.

Data Merging

If you already have data loaded, the Data Merging Wizard appears, where you must choose one of three radio buttons:

- Merge extra channels (more variables)
- Merge extra records (more data, same variables)
- Overwrite old data (use only the new data)

Click **Next**. The wizard summary screen appears, showing the results of the merge. You can click **<Prev** to go back and change merging options.

Note Obviously the merge might not succeed if the data sets do not contain the same variables. A message appears if the merge is impossible when you click **Next**, and you must make another choice.

Click **Finish** to accept the data and return to the Data Editor.

Tailor-Made Excel Sheets

The Data Editor can create a tailor-made Excel sheet for you to fill with data and then import. This sheet will be in the format the Data Editor expects to import data.

1 Select **File > Import Excel**.

Excel is opened with a new sheet created, containing the labeled rows **Name**, **Unit**, and **Data**.

2 Copy your data and variable names into this sheet, then click **Next** in the wizard to import into the Data Editor.

If the data has been entered in the columns in a way that the Data Editor expects, a summary screen shows you information about the numbers, ranges, means, units, and standard deviations of the records and variables you can import.

3 Click **Finish** to import the data.

Creating Variables

In this section...

“How to Create Variables” on page 4-24

“New Variables” on page 4-24

How to Create Variables

You create variables by doing the following:

- Clicking the  toolbar button
- Selecting **Tools > Variables > Add**
- Alternatively, by selecting an existing **Variable List** view by clicking in it, then pressing **Insert**

The Variable Editor appears. See below for instructions.

You can also load user-defined variables from Storage.

New variables you create in the Variable Editor can be viewed in the Data Editor by using the right-click menu in any view to select **Current View > Variable List**. Alternatively, select the menu item **View > Split View > Variable List** to add this new view to the currently selected plot.

You can edit existing variables

- Directly, by select-clicking in the **Variable Expression** pane or pressing **F2** (as in renaming in Windows Explorer)
- By double-clicking, which opens the Variable Editor
- By choosing **Tools > Variables > Edit**
- You can delete variables by selecting them in the **Variable Expression** pane and pressing **Delete**

New Variables

You can define new variables in terms of existing variables:

- Define the new variable by writing an equation in the edit box at the top of the Variable Editor dialog box.

You can type directly in the edit box or add variable names by double-clicking them. In the case of variable names especially, this latter method avoids typing mistakes. Variable names are case sensitive.

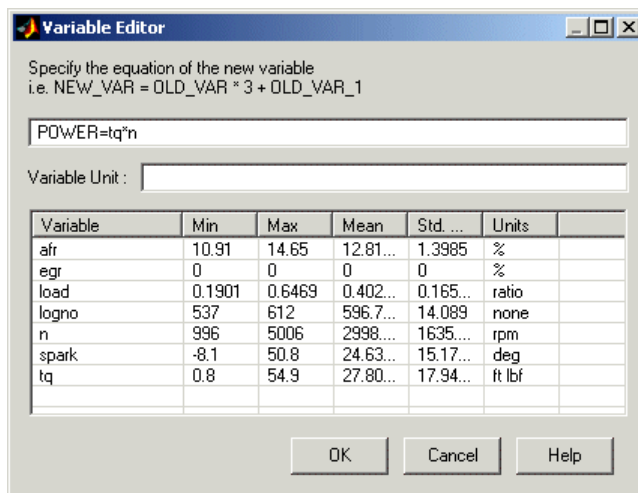

The preceding example shows a definition for a new variable called `POWER` that is defined as the product of two existing variables, `tq` and `n`, by entering `POWER = tq x n`.

- Click **OK** to add the new variable to the current data set.

Note The computation of variable values is vectorized (see in the *MATLAB Programming Fundamentals* documentation) and occurs prior to filtering and clustering. The result must be either a vector the same length as the dataset or a scalar, in which case the value is repeated for every record. The intention is that variables are used on a record-by-record basis.

Note that the Variable Editor looks different depending on whether you opened it to create a new variable or edit an existing one. The example above

shows the editor when adding a new variable. If you open the editor to edit a variable there is an additional list on the left. You can choose which of your existing variables to edit from this list, or click the button to add a new item to the list if you want to add a new variable.

Creating Filters

In this section...

“How to Create Filters” on page 4-27

“Test Filters and Test Notes” on page 4-28

“Filter Editor” on page 4-28

How to Create Filters

You can create filters

- By clicking the toolbar button 
- By selecting **Tools > Filters > Add**
- Alternatively, by selecting an existing **Filter List** view by clicking in it, then pressing **Insert**

The Filter Editor appears. See below for instructions.

You can also load user-defined filters from Storage.

New filters you create in the Filter Editor can be viewed in the Data Editor by using the right-click menu in any view to select **Current View > Filter List**. Alternatively, select the menu item **View > Split View > Filter List** to add this new view to the currently selected plot. Their effects are shown graphically in the bars at the top of the Data Editor — removed data is shown in red.

After you create them, filters can be edited in the same way as variables,

- Directly, after you select-click them in a **Filters List** pane, or by pressing **F2**
- Using **Tools > Filters > Edit**, which opens the Filter Editor
- By double-clicking, which also opens the Filter Editor
- Delete filters by selecting them and pressing **Delete**.

Test Filters and Test Notes

Similarly you can add test filters (to filter out entire tests, instead of individual observations) and test notes (to mark every test that fulfills set criteria). The Test Filter Editor and Test Notes Editor can be reached from the **Tools** menu. You can view these filters in the Data Editor in the same way as the other filters by selecting **Test Filter List** or **Test Notes List** as the type of view. You define, edit, store, and delete these filters in the same way, and they can also be loaded from Storage.

For examples, see “Gasoline Engine Calibration”.

Filter Editor

A filter is a constraint on the data set used to exclude some records. You define the filter using logical operators on the existing variables.

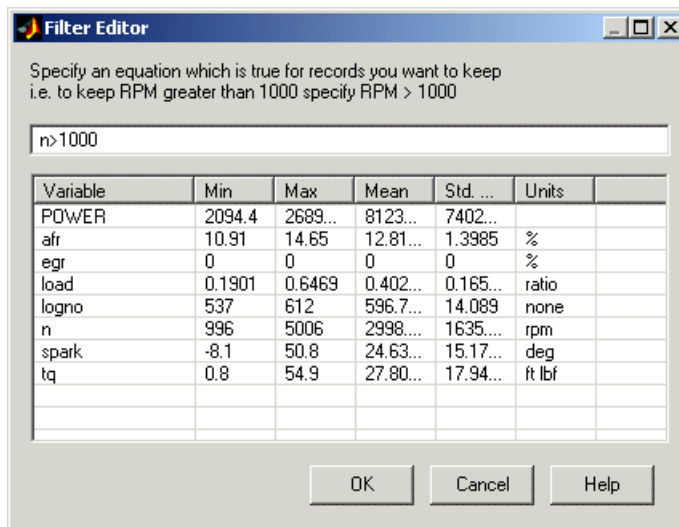

In the preceding example, $n > 1000$, the effect of this filter is to keep all records with speed (n) greater than 1000.

Click **OK** to impose new filters on the current data set.

Note that the Filter Editor looks different depending on whether you opened it to create a new filter or edit an existing one. The example above shows the editor when adding a new filter. If you open the editor to edit a filter there is an additional list on the left. You can choose which of your existing filters to edit from this list, or click the button to add a new item to the list if you want to add a new filter.

Storage

Storage allows you to store plot preferences, user-defined variables, filters, and test notes so that they can be applied to other data sets loaded later in the session.

You can open the Storage window from the Data Editor window in either of these ways:

- Using the menu **Tools > Open Storage**
- Using the toolbar button 

The toolbar buttons **Store Current Variables** and **Store Current Filters**, **Test Filters**, or **Test Notes** allow you to put all user-defined variables and filters from the current session into Storage. They appear in the Storage window.

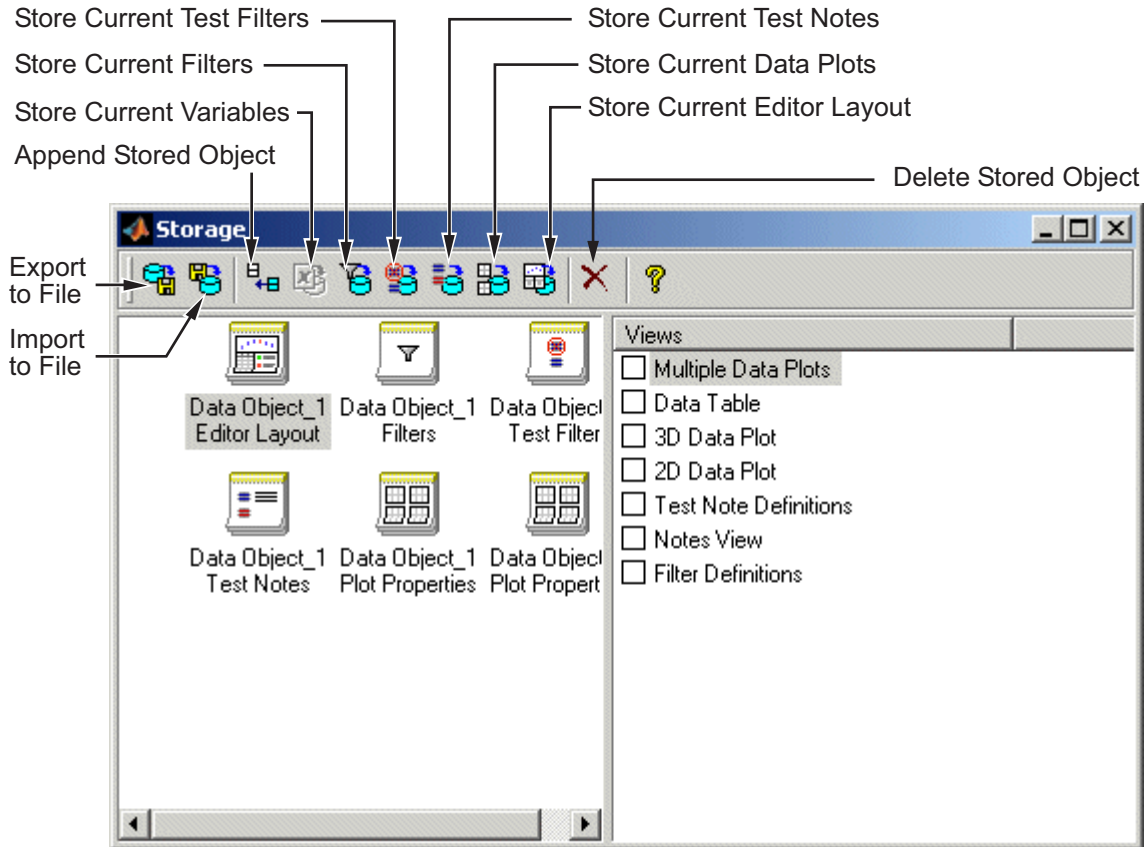

All stored user-defined variables and filters appear here regardless of which project is open — once created and brought into Storage, they remain there. If you do not delete them, they are there indefinitely. You can also store plot settings for multiple data plot views with the toolbar button Get Current Data Plots. All the toolbar functions are described below.

You can select Export to File to send the stored objects to a file. You might do this to move the objects to a different user or machine. Select Import from File to bring such variables and filters into Storage, and use Append Stored Object to add items from Storage to your current project.

You can edit the names of stored objects, by select-clicking as in Windows Explorer, or by clicking once and pressing **F2**.

Note that if you enter the data editor from a modeling node you cannot append variables or filters, as modeling data is read only.

The toolbar buttons in Storage allow the following functions:

- Export to File sends Storage objects to file so they can be sent to another user or machine. Objects remain in Storage indefinitely unless deleted; export is only for transporting elsewhere.
- Import from File loads Storage objects from file; it does not overwrite current objects.
- Append Stored Object appends the currently selected Storage object to those already in the Data Editor window. Double-clicking an object in Storage also appends it to the current session (except Data Editor Layout, which replaces all the current views with the stored layout). If you double-click an object in the left pane the entire object is appended. The pane on the right displays the details of the current object selected in the left pane (variables, filters, or plot properties). In the right pane you can double-click to add these elements individually. For example, you could add a single plot out of several, or a single variable. You can also hold down **Shift** to make multiple selections here.
 - Variables and filters will appear in variable and filter list views. Note that the views are not a requirement for appending variables or filters.
 - Stored Plot Properties (plotted variables, grid style, legend, line style, and so on) apply to multiple data plot views. If you have more than one multiple data plot view open, the stored plot properties are appended to the currently selected view (with the highlighted title bar), or to all views if none are currently selected. The plots stored in a Plot Properties object are added to multiple data plot views as additional plots — they do not overwrite existing plots. You cannot append stored plot properties if you do not have a multiple data plot view open.
- Store Current Variables creates a Storage object containing definitions of all current user-defined variables.

- Store Current Filters creates a Storage object containing definitions of all current filters. Similarly, Store Current Test Filters and Store Current Test Notes create Storage objects containing test filters and test notes.
- Store Current Data Plots creates a Storage object containing the current settings for multiple data plot views (variables plotted and styles for grids, lines, and legends). The settings are taken from the currently selected multiple data plot view. If there are multiple views and none are selected the settings from all the plots are concatenated into a single Plot Properties object.
- Store Current Data Editor Layout creates a Storage object containing the current settings for all the views. Saving a set of views and then double-clicking this object in Storage can be a very quick way to achieve a variety of plots and list views in a new session.

Delete Stored Object deletes the currently selected Storage object.

Test Groupings

The Define Test Groupings dialog box collects records of the current data set into groups; these groups are referred to as *tests*. Test groupings are used to define hierarchical structure in the data for two-stage modeling.

You access the dialog box from the Data Editor by doing one of the following:

- Using the menu **Tools > Change Test Groupings**
- Using the toolbar button 

When you enter the dialog box, no plot is displayed.

- 1 Select a variable in the list box to use in defining groups within the data.
- 2 The **Add Variable** button () adds the currently selected variable in the **Variables** list to the list view on the left. Alternatively, double-click variables to add them.

You can now use this variable to define groups in the data.

In the following example, the variable *n* is being used to define groups. The maximum and minimum values of *n* are displayed.

The **Tolerance** is used to define groups: on reading through the data, when the value of *n* changes by more than the tolerance, a new group is defined. You can change the tolerance by typing directly in the edit box.

You can define additional groups by selecting another variable and choosing a tolerance. Data records are then grouped by *n* or by this additional variable changing outside their tolerances.

You can plot variables without using them to define groups by clearing the **Group By** check box.

You can remove variables from consideration by selecting the unwanted variable in the list view (the selection is highlighted in blue) and clicking the Remove Variable button .

The following plot shows the scaled values of all variables in the list view (the color of the **Tolerance** text corresponds to the color of data points in the plot). Vertical pink bars show the tests (groups). You can zoom the plot by **Shift**-click-dragging or middle-click-dragging the mouse.

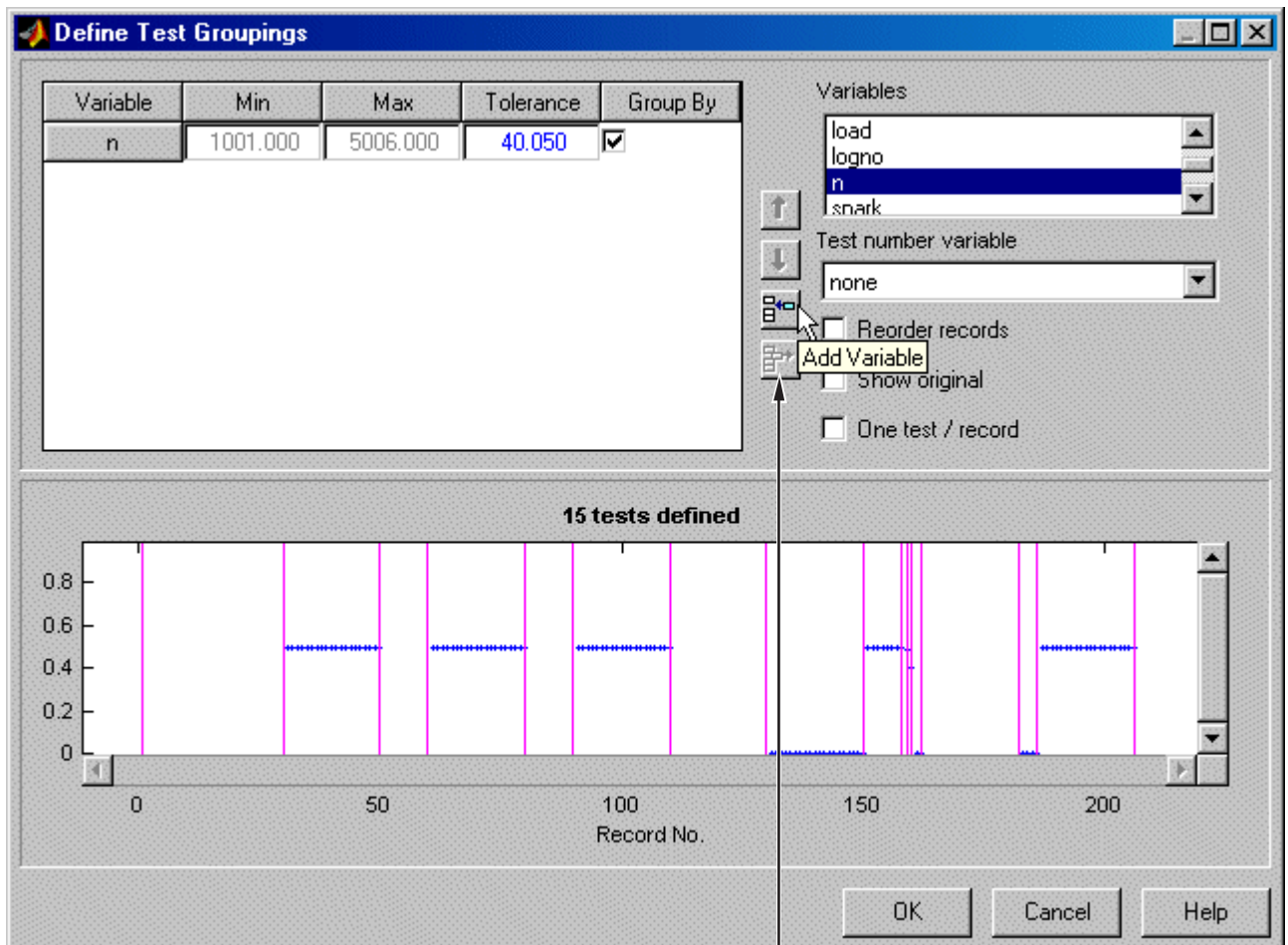

Remove variable

Test number variable contains a drop-down menu showing all the variables in the current data set. You can select any of these to number the tests (for

example, `lognumber` could be useful (instead of 1,2,3...) if the data was taken in numbered tests and you want access to that information during modeling).

Every record in a test must share the same test number to identify it, so when you are using a variable to number tests, the value of that variable is taken in the first record in each test.

Test numbers must be unique, so if any values in the chosen variable are the same, they are assigned new test numbers for the purposes of modeling. (This does not change the underlying data, which retains the correct `lognumber` or other variable.)

Reorder records allows you to reorder records in the data set. This sorts records before grouping. Otherwise, the groups are defined using the order of records in the original data set.

Show original displays the original test groupings if any were defined.

One test/record defines one test per record, regardless of any other grouping. This is required if the data is to be used in creating one-stage models.

Clicking **OK** accepts the test groupings defined and dismisses the dialog box.

Data Selection Wizard

In this section...

“Opening the Data Selection Wizard” on page 4-37

“Step 1: Select Data Set” on page 4-37

“Step 2: Select Input Signals” on page 4-38

“Step 3: Select Response Models” on page 4-40

“Step 4: Set Tolerances” on page 4-41

Opening the Data Selection Wizard

After setting up a new test plan, *if no data has been selected in that test plan*, to open the Data Selection Wizard, do either of the following:

- Choose **Select Data** from the test plan node (toolbar button or **TestPlan** menu item)
- Double-click the Responses block in the test plan diagram

Step 1: Select Data Set

Use the first screen of the wizard to select the data set to build models from. You can also select whether to use all the data set or to match the data to a design, if any designs are in use in the test plan. Designs appear in the left list box, data sets on the right, and you can click the button to load a new data set.

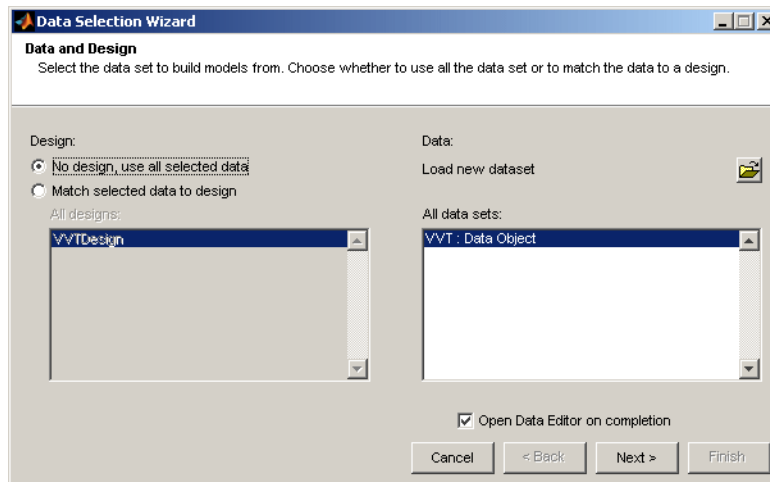

Step 2: Select Input Signals

Select the input signals for the model (on all stages of the hierarchical model) from the list box of data signals on the right, and match them to the correct model variables using the big button with the arrow. Double-clicking an item in the data signals list selects that signal for the currently selected input factor (with the range if the **Copy range** check box is selected) and then moves to the next input.

If you entered the correct signal name at the model setup stage, the appropriate signal is automatically selected as each model input factor is selected. This can be time-saving if there are many data signals in a data set. If the signal name is not correct, you must click to select the correct variable for each input.

Select the check box **Copy range** if you want to use the range of the selected data signal for the model input range. Ranges are not automatically copied, although stored templates have the ranges that were set when the template was saved.

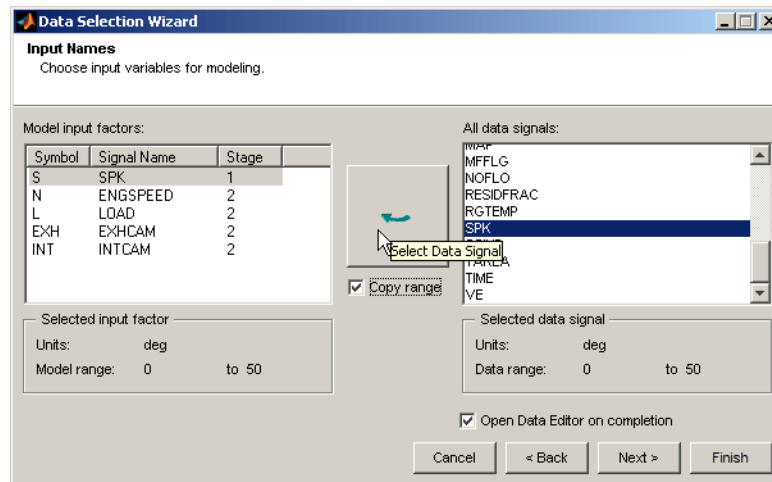

If you want to exit without selecting response models, you can click **Finish**. For example, you may want to create boundary models or designs without building response models. If you do not want to inspect or edit the data, clear the check box **Open Data Editor on completion**.

To continue to selecting response models, click **Next**.

Step 3: Select Response Models

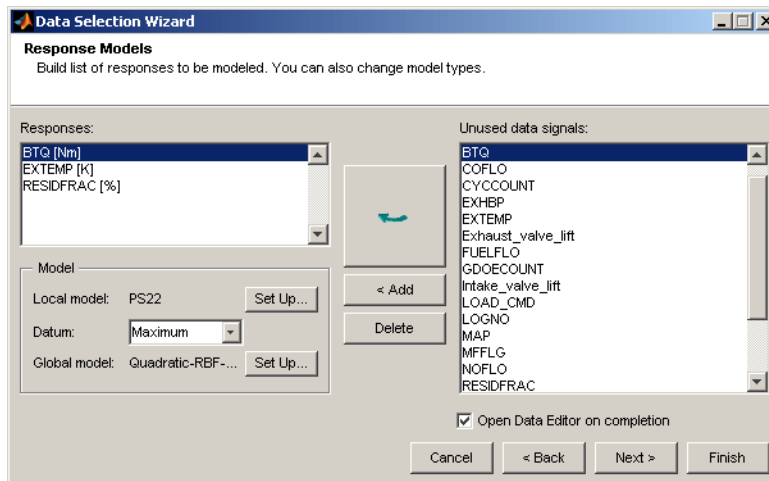

Use the following controls to set up your models:

- If starting with an empty **Responses** list box, select the desired response in the **Unused data signals** list, and click **Add**.

If you are using a test plan template, responses may already be specified in the **Responses** list box. If you want to change a response, select a signal and click the large button with the arrow to replace the current selected response. The previous response appears in brackets to inform you what has changed.

When there is already a response in the list box, clicking **Add** does not replace the selection but increases the number of responses. The replace button (with the arrow) is not available when the **Responses** box is empty.

- You can use **Delete** to remove selected responses.
- You can select Datum models (if the local model supports them), and you can use the **Set Up** buttons to change the local and global models. See “Local Model Setup” on page 5-4, “Global Model Setup” on page 5-66, and “Datum Models” on page 5-88 for details.

If the check box **Open Data Editor on completion** is selected, when you click **Finish** the Data Editor opens to select data for modeling. The models,

however, are not built until you close the Data Editor. Clear the check box **Open Data Editor on completion** if you have already inspected the data, and want to use all the data for modeling. When you click **Finish** the models are built.

You can only click **Next** if you are matching data to a design. See “Step 4: Set Tolerances” on page 4-41.

Step 4: Set Tolerances

You only reach Step 4 if you are matching data to a design. Setting tolerances is only relevant if you are matching data to a design. You can only match data to designs for global models.

You can also edit tolerances later using the **Tools** menu in the Data Editor window. See “The Tolerance Editor” on page 4-49 for definitions of clusters.

Set **Input factor tolerances** for each variable to determine the size of the tolerance in each dimension. This is used for selecting data. The tolerance in each dimension determines the size of “clusters” centered on each design point. Data points that lie within tolerance of a design point are included in that cluster. Data points that fall inside the tolerance of more than one design point form a single cluster containing all those design and data points. If no data points fall within tolerance of a particular design point, they remain unmatched. Default tolerance values are related to variable ranges.

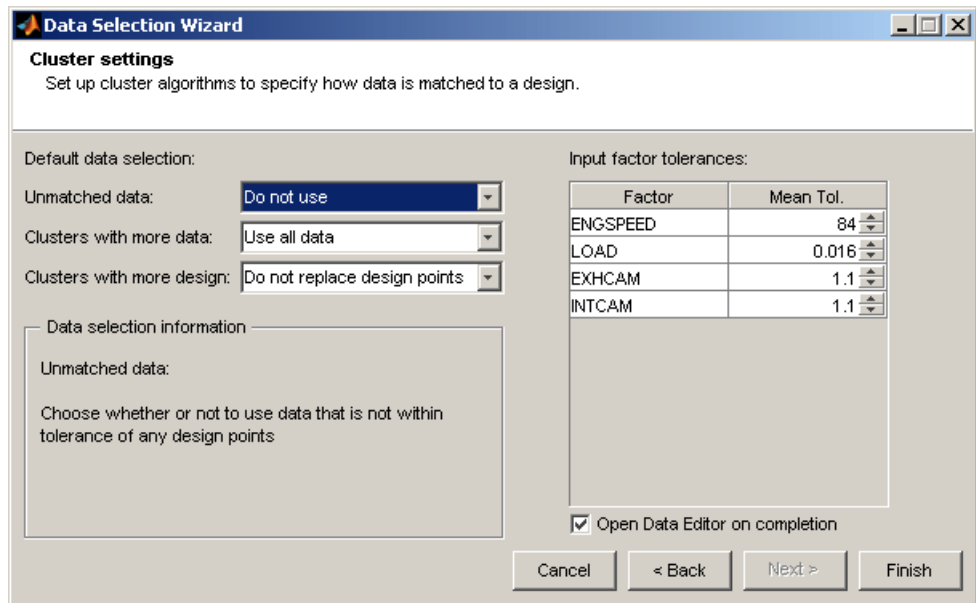

The choices you make in the **Default data selection** options determine how the cluster algorithm is first run to select matching data and design points. This only affects the status of the check boxes for data and design points when you first see the Cluster Plot view in the Data Editor. You can always alter the results of this later in the Cluster Information list view, where you can manually select the data and design points you want to use.

When you exit the Data Editor these selections determine what data is used for modeling and how design points are augmented and replaced. Selected data is used for modeling and added to the design. Data you have decided to exclude is not used for modeling or added to the design.

- **Unmatched data** — Use or Do not use

Data that does not lie within tolerance of any design point is unmatched. You can decide what to do with these. If you select **Use**, this data is selected for modeling and added to your design.

If you select **Do not use**, then unmatched data is not used for modeling or added to the design; it is excluded data.

- **Clusters with more data** — Use all data or Use closest match only

This refers to clusters containing more data points than design points. If you choose `Use all data`, all the data points in these clusters are selected for modeling and added to the design, replacing the design points in those clusters.

If you choose `Use closest match only`, then a one-to-one match of the data point closest to each design point is selected, and these are the only points that are selected for modeling and added to the design (replacing a design point each).

- **Cluster with more design** — Do not replace design points or Replace design with closest

All data from these clusters is selected for modeling. The setting here only affects selections for the design.

Where clusters contain more design points than data points, you can choose to leave the design unchanged by selecting `Do not replace design points`.

If you choose `Replace design with closest`, this replaces the design points where possible with the closest data point and leaves the rest of the design points unchanged.

Remember you can override any of these selections manually in the Data Editor; changes are only applied when you close the Data Editor after matching. The cluster plots view in the Data Editor window appears by default when you close the Data Wizard while you are matching data to designs. See the next section, “Matching Data to Designs” on page 4-44.

Matching Data to Designs

In this section...
“Introducing the Cluster Plot View” on page 4-44
“How to Use the Cluster Plot View” on page 4-46
“The Tolerance Editor” on page 4-49
“What Will Happen to My Data and Design?” on page 4-50

Introducing the Cluster Plot View

The Cluster Plot view is designed for matching data to experimental designs for global models. Here you can select data for modeling. You can use an iterative process: make a design, collect some data, match that data with your design points, modify your design accordingly, then collect more data, and so on. You can use this process to optimize your data collection process in order to obtain the most robust models possible with the minimum amount of data.

Use the Cluster Plot view and associated Cluster Information List view to select data for modeling. All data you select is also added to a new design called **Actual Design**. You can use the matching process to produce an **Actual Design** that accurately reflects your current data. You can then use this new design to decide the best points to use if you want to augment your current design in order to collect more data.

The following example shows the Data Editor displaying a Cluster Plot view and Cluster Information List view. You can right-click to change and add views as for the rest of the Data Editor displays.

Data Editor

File View Tools Window Help

200 / 200 records
8 + 0 variables
200 / 200 tests

Legend: ■ Data remaining ■ Data removed ■ Variables added

Source files: Workspace

Cluster Plot

Statistics

Design Points	200
Matched De...	170
Unmatched ...	30
Data in Design	0
Data Points	200
Matched Data	170
Unmatched ...	30
Excluded Data	0
Clusters	170
Green Clusters	170
Blue Clusters	0

Current Cluster

Design...	1
Data P...	1
Design...	195
Test N...	195

X-axis factor: load Y-axis factor: speed

Matched Data Matched Design Excluded Data
 Unmatched Data Unmatched Design Data in Design
 Equal Data and Design More Data than Design Less Data than Design

Cluster Information

Test Number	Design Indices in Tolerance	load	spe	Design Index	Test Numbers in Tolerance	load	spe
<input checked="" type="checkbox"/> 195	195	0.6426	637	<input checked="" type="checkbox"/> 195	1	0.6347	648

Data has 200/200 Records, 8 + 0 Variables, and 200 Tests.

For instructions, see the following section, “How to Use the Cluster Plot View” on page 4-46.

How to Use the Cluster Plot View

For a step-by-step guide to matching data to a design using an example project, see “Matching Data to Designs” on page 4-44 in the Getting Started documentation.

You can **Shift**+click (or center+click) and drag to zoom in on clusters of interest, as shown in the following example. Double-click the plot to return to full size.

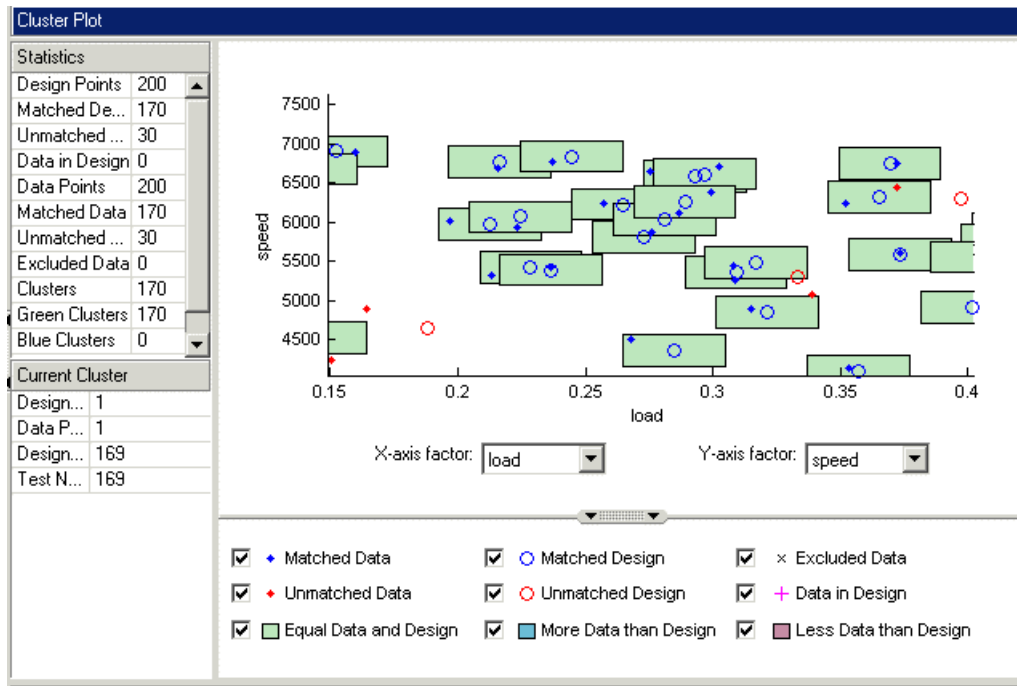

We suggest the following sequence as a guideline for matching data to designs using the Cluster Plot:

- 1** It is unlikely that you will get the tolerances right immediately. Open the Tolerance Editor using the **Tools** menu and try different values for different variables. These values determine the size of clusters centered on each design point. Data points that lie within tolerance of any design point in a cluster are matched to that cluster. See “The Tolerance Editor” on page 4-49 for cluster definitions.
- 2** For matching data to designs, you might want to clear the check box in the Cluster Plot for green clusters (with equal data and design points). These clusters are matched; you are more likely to be interested in unmatched points and clusters with uneven numbers of data and design points. Removing the green clusters allows you to focus on these points of interest. If you want your new Actual Design to accurately reflect your current data, your aim is to get as many data points matched to design points as possible, that is, as few red clusters as possible. See “Red Clusters” on page 4-48.
- 3** You can see the values of variables at different points by clicking and holding. Selected points have a pink border. Once points are selected, you can change the plot variables using the X- and Y-axis factor drop-down menus to track those points through the different dimensions.

This can give you a good idea of which tolerances to change in order to match points. Remember that points that do not form a cluster can appear to be perfectly matched when viewed in one pair of dimensions; you must view them in other dimensions to find out where they are separated beyond the tolerance value. Use this tracking process to decide whether you want particular pairs of points to be matched, and then change the tolerances until they form part of a cluster.

Remember that points you select in the cluster view are selected across the Data Editor, so if you have other data plots or a table view open you can investigate the same points in different views.

- 4** Once you have found useful values for the tolerances by trial and error, you can make selections of points within clusters that have uneven numbers of data and design points. These clusters are blue (more data than design) or red (more design than data). Select any cluster by clicking it. The details of every data and design point contained in the selected cluster appear in the Cluster Information List view. Choose the points you want to keep or discard by selecting or clearing the check boxes next to each point in the Cluster Information List view. Notice that your selections can cause

clusters to change color as you adjust the numbers of data and design points within them.

- 5** You can also select unmatched points by right-clicking and selecting **Viewer Options > Select Unmatched Data**. All unmatched points then appear in the Cluster Information List view. You can decide whether to include or exclude them in the same way as points within clusters, by using the check boxes in the Cluster Information List view. If you decide to exclude data points (within clusters or not) they appear on the plot as black crosses (if the **Excluded Data** check box is selected for display).

Note that it is a single fast operation to multiple-select points before selecting or clearing a check box, rather than selecting points individually. To do this, use **Shift**+click to select multiple points and hold the **Shift** key when clicking one of the check boxes.

You can right-click and select **Viewer Options > Show Labels** to see design and data point numbers on the plot (also in the View menu).

Continue this process of altering tolerances and making selections of points until you are satisfied that you have selected all the data you want for modeling. All selected data is also added to your new Actual Design, except that in red clusters.

Red Clusters

These contain more design points than data points. These data points are not added to your design, because the algorithm cannot choose the design points to replace, so you must manually make selections to deal with red clusters if you want to use these data points in your design. If you don't care about the Actual Design (for example, if you do not intend to collect more data) and you are just selecting data for modeling, then you can ignore red clusters. The data points in red clusters are selected for modeling. For information about the effects of your selections, see "What Will Happen to My Data and Design?" on page 4-50.

The Tolerance Editor

You can open the Tolerance Editor by selecting **Tools > Tolerances**.

Here you can edit the tolerance for selecting data points. You can choose values for each variable to determine the size of tolerance in each dimension.

- Data points within the tolerance of a design point are included in that cluster.
- Data points that fall inside the tolerance of more than one design point form a single cluster containing all those design and data points.
- Excluded data (shown as black crosses) that lies within tolerance appears in the Cluster Information list when that cluster is selected. You can then choose whether to use it or continue to exclude it.
- Data in Design (pink crosses) is the only type of data that is not included in clusters.

Note Tolerances are set for global variables. Data used for matching uses test means of global variables, not individual records, unlike other Data Editor views. Click points to inspect values of global variables.

Using the Tolerance Editor is the same process as setting tolerances within the Data Wizard. In the Data Wizard you can also choose in advance what to do with unmatched data and clusters with uneven numbers of data and design points. These choices affect how the cluster algorithm is first run; you can always change selections later in the Data Editor. See “Step 4: Set Tolerances” on page 4-41.

Note If you modify the data in any way while the cluster plot view is open (e.g., by applying a filter) the cluster algorithm will be rerun. You might lose your design point selections.

See the next section, “What Will Happen to My Data and Design?” on page 4-50, for information about what happens to your data set and design when you close the Data Editor after data selection in the cluster plot view.

What Will Happen to My Data and Design?

As with everywhere else in the Data Editor, the changes you make are only applied to the data set when you exit. When you close the Data Editor, your choices in the cluster plots are applied to the data set and a new design called **Actual Design** is created. All the changes are determined by your check box selections for data and design points.

Note All data points with a selected check box are selected for modeling. All data points with a cleared check box are excluded from the data set.

All data points with a selected check box are put into the new **Actual Design** *except* those in red clusters. See below.

When you close the Data Editor, these changes are applied:

- Green clusters — equal number of data and design points

The design points are replaced by the equal number of data points. These points become fixed design points (red in the Design Editor table) and appear as Data in Design (pink crosses) when you reopen the Data Editor.

This means that these points are not included in clusters when matching again. These fixed points are also not changed in the Design Editor when you add points, although you can unlock fixed points if you want. This can be very useful if you want to optimally augment a design, taking into account the data you have already obtained.

- Blue clusters — more data than design points

The design points are replaced by all the data points.

Note Design points with selected check boxes in green or blue clusters are the points that will be replaced by your selected data points. You may have cleared the check boxes of other design points in these clusters, and these points will be left unchanged.

- Red Clusters — more design than data points

Red clusters indicate that you should make a decision if you want your new **Actual Design** to reflect your most current data. The algorithm cannot choose the design points to replace with the data points, so no action is taken. Red clusters do not make any changes to the design when you close the data editor. The existing design points remain in the design. The data points are included or excluded from the data set depending on your selections in the Cluster Information list, but they are not added to the design.

- **Unmatched Design Points**

These remain in the design.

- **Unmatched Data Points**

If you have selected the check boxes for unmatched data, they become new fixed design points, which are red in the Design Editor. When you reopen the Data Editor these points are Data in Design, which appear as pink crosses. Note that in the Data Wizard you could choose **Use** to select all these initially, or you could choose **Do not use**, which clears all their check boxes. See “Step 4: Set Tolerances” on page 4-41.

- **Data in Design**

These remain in the design.

- **Excluded Data**

These data points are removed from the data set and are not displayed in any other views. If you want to return them to the data set you can only do so by selecting them in the Cluster Plot view.

Data Loading Application Programming Interface

Data Loading API Specification

You can use the data loading API (application programming interface) to write your own data loading function, plug these functions into the toolbox, and subsequently use data loaded by these functions within the toolbox. To allow this, there are several stages that need to be followed as described below. For an example, see `xregReadConcerto.m` (in the `mbctools` directory).

Data Function Prototype

A function to successfully load data has the following prototype:

```
[OK, msg, out] = dataLoadingFcn(filename, protoOut)
```

Input Arguments

`filename` is the full path to the file to be loaded.

`protoOut` is an empty structure with the fields expected in the return argument `out`. This allows the data loading API to be easily extended without the need for data loading functions to change when the toolbox changes.

Output Arguments

The first return argument, `OK`, allows the function to signal that it has successfully loaded the data file. A value of 1 signals success, and 0 failure. If the function fails, it can return a message, `msg`, to indicate the reason for the failure. This message is displayed in a warning dialog box if the function fails. If the function is successful, the return argument `out` contains the data necessary for the toolbox.

`out.varNames` is a cell array of strings that hold the names of the variables in the data (1 x n or n x 1).

`out.varUnits` is a cell array of strings that hold the units associated with the variables in `varNames` (1 x n or n x 1). This array can be empty, in which case no units are defined.

`out.data` is an array that holds the values of the variables ($m \times n$).

`out.comment` is an optional string holding comment information about the data.

Data Function Check In

Once you have written the function, you need to check it into the toolbox, using the `mbccheckindataloadingfcn` function. This function has the following prototype:

```
OK= mbccheckindataloadingfcn(fun, filterSpec, fileType, filename)
```

`fun` is a string that is the function to call to load the data. This function must be on the MATLAB path.

`filterSpec` is a 1×2 element cell array that contains the extensions that this function loads and the descriptions of those files. This cell array is used in the `uigetfile` function, for example, `{ '*.m;*.fig;*.mat;', 'All MATLAB Files' }` or `{ '*.m', 'M-files (*.m)' }`. MBC attempts to decide automatically which sort of file is loaded, based on the extension. In the case of duplicate extensions, the first in the list is selected; however, it is always possible to override the automatic selection with a user selection. You will see a warning message if there is any ambiguity.

`fileType` is a string that describes the file type, for example, 'MATLAB file' or 'Excel file'.

Setting Up Models

This section discusses the following topics:

- “What Models Are Available?” on page 5-2
- “Local Model Setup” on page 5-4
- “Boundary Model Setup” on page 5-46
- “Global Model Setup” on page 5-66
- “New Response Models and Datum Models” on page 5-87
- “Build Alternative Models to Compare” on page 5-90
- “Parallel Model Building” on page 5-95

What Models Are Available?

The following table shows the model types available for one-stage and two-stage modeling.

Model Type	One Stage and Two Stage Global	Two Stage: Local
Linear model	Yes	Yes
Radial basis function (RBF)	Yes	
Hybrid RBF	Yes	
Interpolating RBF	Yes	
Multiple linear models	Yes	
Free knot spline	Yes, one factor only	Yes, one factor only
Neural net (requires Neural Network Toolbox™ software)	Yes	
Average fit		Yes
Multiple models*		Yes
Growth models		Yes, one factor only
Polynomial**		Yes, one factor only
Polynomial spline**		Yes, one factor only
Truncated power series		Yes, one factor only
User defined#	Yes (the example is one factor only)	Yes
Transient#	Yes (the example is two factors only)	Yes

*Multiple Models gives you access to global model types for your local model.

** Polynomial and polynomial spline are two special case linear models for local models with one input factor. You can use polynomial and polynomial

spline models (with more settings) for local models with more factors by choosing Linear Models.

User defined and transient models must be checked into the toolbox before you can use them. They will be available only for the number of factors you specified. There is an example user-defined model for a single factor preregistered with the toolbox. The example transient model provided must have exactly two factors, one of which must be time. See “Local Model Class: User-Defined Models” on page 5-26 and “Local Model Class: Transient Models” on page 5-35 for details.

Local Model Setup

In this section...

- “Introducing Local Model Setup” on page 5-4
- “Local Model Class: Polynomials and Polynomial Splines” on page 5-5
- “Local Model Class: Truncated Power Series” on page 5-9
- “Local Model Class: Free Knot Spline” on page 5-11
- “Local Model Class: Growth Models” on page 5-12
- “Local Model Class: Linear Models” on page 5-19
- “Local Model Class: Average Fit” on page 5-20
- “Local Model Class: Multiple Models” on page 5-22
- “Local Model Class: User-Defined Models” on page 5-26
- “Local Model Class: Transient Models” on page 5-35
- “Covariance Modeling” on page 5-42
- “Correlation Models” on page 5-44
- “Transforms” on page 5-44

Introducing Local Model Setup

The available models depend on the number of input factors. Polynomial, polynomial spline, truncated power series, free knot spline, and growth models are for one factor only.

You can choose additional response features at this stage using the **Response Features** tab. These can also be added later. The Model Browser automatically chooses sufficient response features for the current model.

See each local model type for statistical details and available response features.

See also

- “Covariance Modeling” on page 5-42

- “Correlation Models” on page 5-44
- “Transforms” on page 5-44

Local Model Class: Polynomials and Polynomial Splines

Polynomials

At the local level, if you have one input factor, you can choose Polynomial directly from the list of local model classes. Here you can choose the order of polynomials used, and you can define a datum model for this kind of local model (see below).

If there is more than one input factor, you can choose Linear Models from the Local Model Class list, then you can choose Polynomial or Hybrid Spline. This is a different polynomial model where you can change more settings such as Stepwise, the Term Editor (where you can remove any model terms) and you can choose different orders for different factors (as with the global level polynomial models). See “Local Model Class: Linear Models” on page 5-19.

Different response features are available for this polynomial model and the Linear Models: Polynomial choice. You can view these by clicking the **Response Features** tab on the Local Model Setup dialog box. Single input polynomials can have a datum model, and you can define response features relative to the datum. See “Datum Models” on page 5-88.

The following response features are permitted for the polynomial model class:

- Location of the maximum or minimum value (when using datum models; note that the datum model is not used in reconstructing).
- Value of the fit function at a user-specified x-ordinate. When datum models are used, the value is relative to the datum (for example, $mbt - x$).
- The n^{th} derivative at a user-specified x-ordinate, for $n = 1, 2, \dots, d$ where d is the degree of the polynomial.

See the global model section “Polynomials” on page 5-67 for a general description of polynomial models.

Polynomial Spline

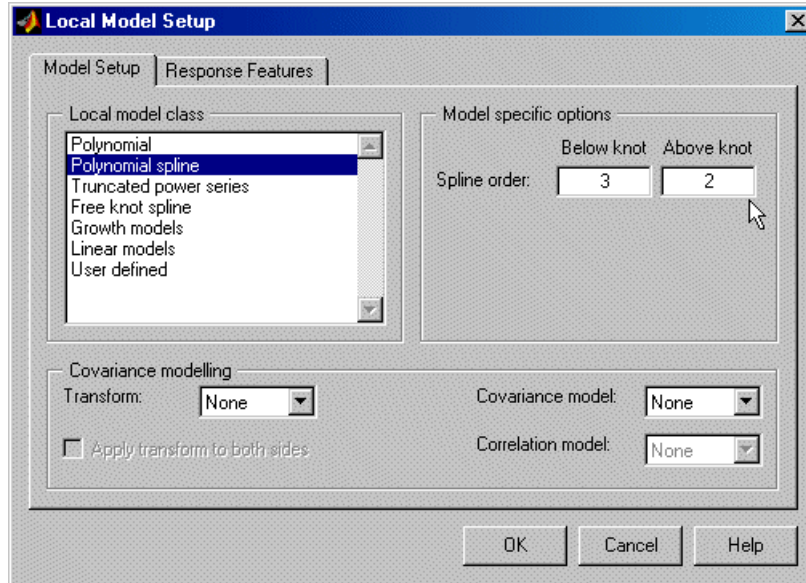

A spline is a piecewise polynomial, where different sections of polynomial are fitted smoothly together. The location of each break is called a knot. Polynomial splines are essential for modeling torque/spark curves.

This model has only one knot. You can choose the orders of the polynomials above and below the knot. See also “Hybrid Splines” on page 5-68. These global models also use splines, but use the same order polynomial throughout.

Polynomial splines are only available for single input factors. The following example shows a typical torque/spark curve, which requires a spline to fit properly. The knot is shown as a red spot at the maximum, and the curvature above and below the knot is different. In this case there is a cubic basis function below the knot and a quadratic above.

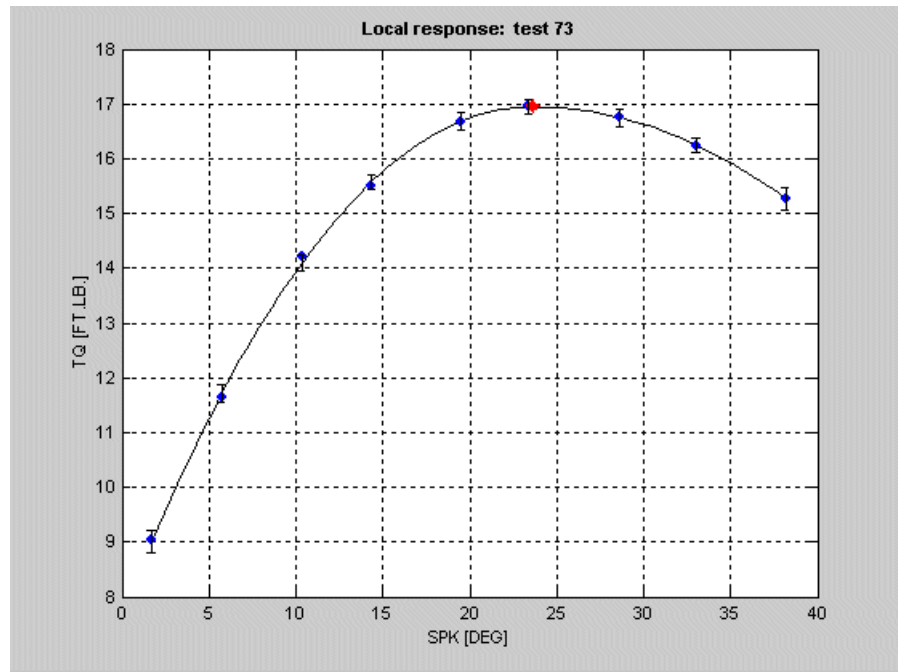

To model responses that are characterized in appearance by a single and well defined stationary point with asymmetrical curvature either side of the local minimum or maximum, we define the following spline class,

$$y_{ij} = \beta_0 + \sum_{a=2}^c \beta_{Low_a} (x_j - k)_+^a + \sum_{b=2}^h \beta_{High_b} (x_j - k)_-^b$$

where k is the knot location, β denotes a regression coefficient,

$$(x_j - k)_- = \min\{0, (x_j - k)\}, (x_j - k)_+ = \max\{0, (x_j - k)\}$$

where c is the user-specified degree for the left polynomial, h is the user-specified degree for the right polynomial, and the subscripts Low and High denote to the left (below) and right of (above) the knot, respectively.

Note that by excluding terms in $(x_j - k)_-$ and $(x_j - k)_+$ we ensure that the first derivative at the knot position is continuous. In addition, by definition the constant β_0 must be equal to the value of the fit function at the knot, that is, the value at the stationary point.

For this model class, response features can be chosen as

- Fit constants $\{\beta_0, \beta_{Low_2}, \dots, \beta_{Low_p}, \beta_{High_2}, \beta_{High_q}\}$
- Knot position $\{k\}$
- Value of the fit function at a user-specified delta

$$\{\Delta a_j = x_j - k\}$$

from the knot position $\{f(\pm \Delta a_j)\}$ if the datum is defined, otherwise the value is absolute.

- Difference between the value of the fit function at a user-specified delta from the knot position and the value of the fit function at the knot

$$\{f(\pm \Delta a_j) - f(k)\}$$

Local Model Class: Truncated Power Series

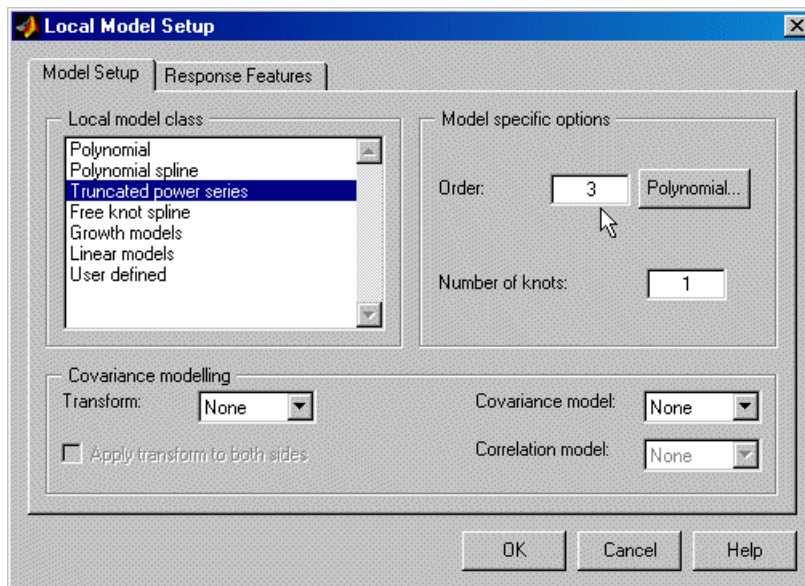

This is only available for a single input factor.

You can choose the order of the polynomial basis function and the number of knots for Truncated Power Series Basis Splines. A spline is a piecewise polynomial, where different sections of polynomial are fitted smoothly together. The point of each break is called a knot. The truncated power series changes the coefficient for the highest power when the input passes above the knot value.

It is *truncated* because the power series is an approximation to an infinite sum of polynomial terms. You can use infinite sums to approximate arbitrary functions, but clearly it is not feasible to fit all the coefficients.

Click **Polynomial** to see (and remove, if you want) the polynomial terms. One use of the remove polynomial term function is to make the function linear until the knot, and then quadratic above the knot. In this case we remove the quadratic coefficient.

See also

- “Polynomial Spline” on page 5-6, where you can choose different order basis functions either side of the knot
- “Hybrid Splines” on page 5-68, a global model where you can choose a spline order for one of the factors (the rest have polynomials fitted)
- “Local Model Class: Free Knot Spline” on page 5-11, free knot splines , where you can choose the number of knots and the order of the basis functions

Truncated Power Series Basis (TPSBS) Splines

A very general class of spline functions with arbitrary (but strictly increasing) knot sequence:

$$\mathbf{k} = \{k_1, k_2, \dots, k_k\}^T$$

$$f(x) = \sum_{i=0}^m \beta_i x^i + \sum_{i=0}^k \beta_{m+i} (x - k_i)_+^m$$

This defines a spline of order m with knot sequence $\mathbf{k} = \{k_1, k_2, \dots, k_k\}^T$

For this model class, response features can be chosen as

- Fit constants $\{\beta_0, \beta_1, \dots, \beta_{m-1+k}\}$
- Knot position vector $\{\mathbf{k}\}$.
- Value of the fit function $\{f(a_j)\}$ at a user-specified value $\{a_j\}$
- Value of the n^{th} derivative of the fit function with respect to x_j $\{f^{(n)}(a_j)\}$ at a user-specified value $\{a_j\}$, with $n = 1, 2, \dots, m-2$

Any of the polynomial terms can be removed from the model.

Local Model Class: Free Knot Spline

These are the same as the “Global Model Class: Free Knot Spline” on page 5-82 (which is also only available for one input factor). See the global free knot splines for an example curve shape.

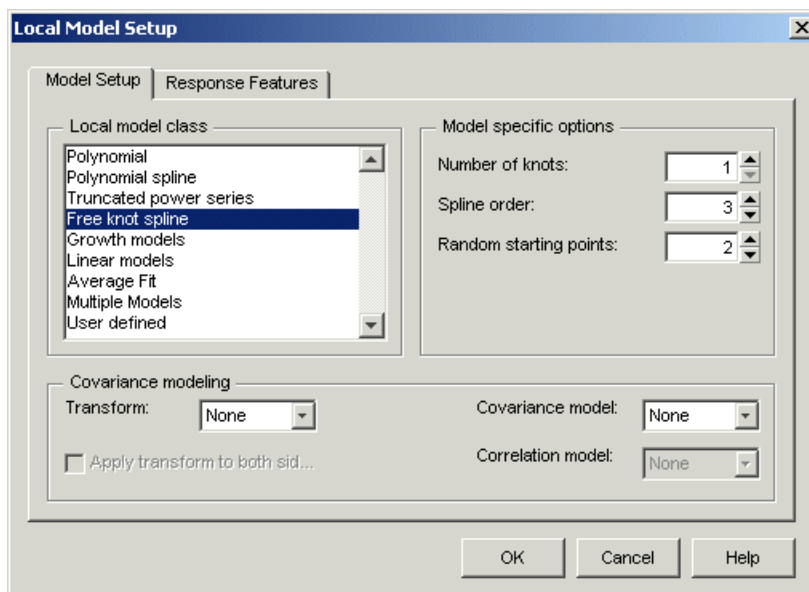

A spline is a piecewise polynomial, where different sections of polynomial are fitted smoothly together. The point of the join is called the knot.

You can choose the number of knots. You can choose the order of polynomial fitted (in all curve sections) from 1 to 3. The default is cubic.

You can set the number of **Random starting points**. These are the number of initial guesses at the knot positions.

See also

- “Polynomial Spline” on page 5-6, where you can choose different order basis functions for either side of the knot

- “Local Model Class: Truncated Power Series” on page 5-9, where you can choose the order of the basis function
- “Hybrid Splines” on page 5-68, a global model where you can choose a spline order for one of the factors (the rest have polynomials fitted)

Free Knot Splines

The $(x_j - k_i)_+^{m-1}$ basis is not the best suited for the purposes of estimation and evaluation, as the design matrix might be poorly conditioned. In addition, the number of arithmetic operations required to evaluate the spline function depends on the location of x_i relative to the knots. These properties can lead to numeric inaccuracies, especially when the number of knots is large. You can reduce such problems by employing *B-splines*.

The most important aspect is that for moderate m the design matrix expressed in terms of B-splines is relatively well conditioned.

For this model class, response features can be chosen as

- Fit constants $\{\beta_{-(m-1)}, \beta_{-m}, \dots, \beta_k\}$
- Knot position vector $\{k\}$.

Value of the fit function $\{f(a_j)\}$ at a user specified value $\{a_j\}$

Local Model Class: Growth Models

Growth models have a number of varieties available, as shown. They are only available for single input factors.

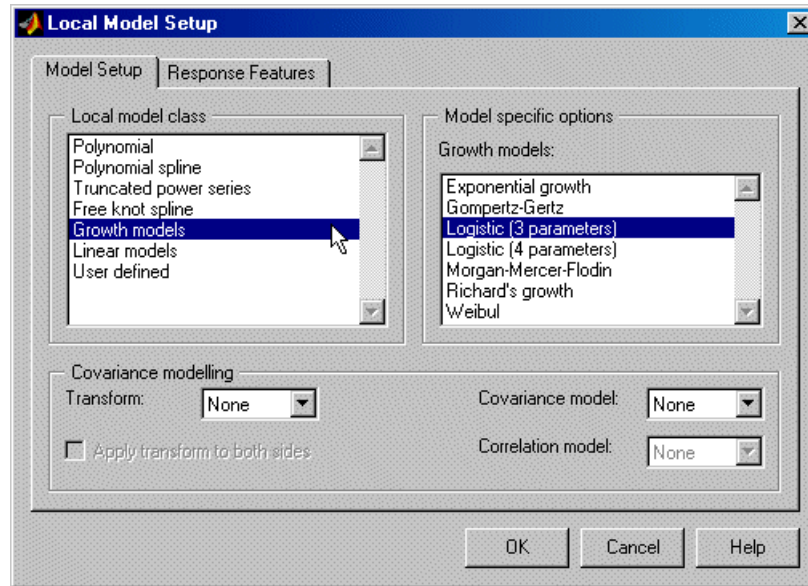

These are all varieties of sigmoidal curves between two asymptotes, like the following example.

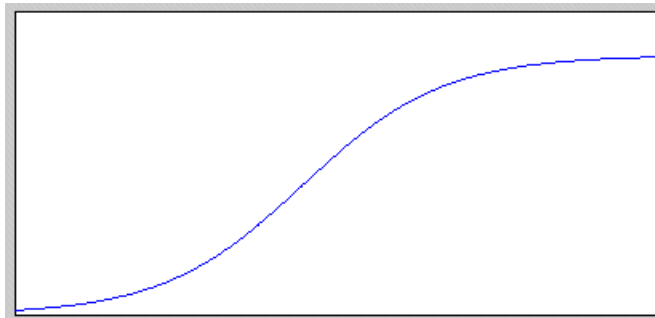

Growth models are often the most appropriate curve shape for air charge engine modeling.

See the following sections for mathematical details on the differences between these growth models:

- “Three Parameter Logistic Model” on page 5-14
- “Morgan-Mercer-Flodin Model” on page 5-15
- “Four-Parameter Logistic Curve” on page 5-15
- “Richards Curves” on page 5-17
- “Weibul Growth Curve” on page 5-17
- “Exponential Growth Curve” on page 5-18
- “Gompertz Growth Model” on page 5-19

Three Parameter Logistic Model

The three parameter logistic curve is defined by the equation

$$y_j = \frac{\alpha}{1 + \exp(-\kappa(x_j - \gamma))}$$

where α is the final size achieved, κ is a scale parameter, and γ is the x-ordinate of the point of inflection of the curve.

The curve has asymptotes $y_j = 0$ as $x_j \rightarrow -\infty$ and $y_j = \alpha$ as $x_j \rightarrow \infty$. Growth rate is at a maximum when $y_j = \alpha/2$, which occurs when $x_j = \gamma$. Maximum growth rate corresponds to

$$\frac{\kappa\alpha}{4}$$

The following constraints apply to the fit coefficients:

$$\alpha > 0, \kappa > 0, \gamma > 0.$$

The response feature vector \mathbf{g} for the 3 parameter logistic function is defined as

$$\mathbf{g} = \left[\alpha \quad \gamma \quad \kappa \quad \frac{\kappa\alpha}{4} \right]^T$$

Morgan-Mercer-Flodin Model

The Morgan-Mercer-Flodin (MMF) growth model is defined by

$$y_j = \alpha - \frac{\alpha - \beta}{\left(1 + (\kappa x_j)^\delta\right)}$$

where α is the value of the upper asymptote, β is the value of the lower asymptote, κ is a scaling parameter, and δ is a parameter that controls the location of the point of inflection for the curve. The point of inflection is located at

$$x = \left[\frac{\delta - 1}{\delta + 1}\right]^{1/\delta}$$

$$y = \frac{\delta - 2}{2\delta}$$

for $\delta \geq 1$

There is no point of inflection for $\delta < 1$. All the MMF curves are sublogistic, in the sense that the point of inflection is always located below 50% growth (0.5a). The following constraints apply to the fit coefficient values:

$$\alpha > 0, \beta > 0, \kappa > 0, \delta > 0$$

$$\alpha > \beta$$

The response feature vector \mathbf{g} is given by

$$\mathbf{g} = \left[\alpha \quad \beta \quad \kappa \quad \delta \quad \frac{\delta - 1}{2\delta} \right]^T$$

Four-Parameter Logistic Curve

The four-parameter logistic model is defined by

$$\beta - \frac{(\alpha - \beta)}{\left(1 + \frac{e^{\gamma\kappa}}{x^\kappa}\right)}$$

with constraints $\alpha, \beta, \kappa, \gamma > 0$, $\beta < \alpha$ and $\beta < \gamma < \alpha$. Again, α is the value of the upper asymptote, κ is a scaling factor, and γ is a factor that locates the x-ordinate of the point of inflection at

$$\exp\left(\frac{\kappa\gamma - \log\left(\frac{1 + \kappa}{\kappa - 1}\right)}{\kappa}\right)$$

The following constraints apply to the fit coefficient values:

- All parameters > 0
- $\alpha > \beta$

This is the available response feature vector:

$$g = \left[\alpha \quad \beta \quad \kappa \quad \gamma \quad \frac{\left(\kappa\gamma - \log\left(\frac{1 + \kappa}{\kappa - 1}\right)\right)}{\kappa} \right]^T$$

Richards Curves

The Richards curves family of growth models is defined by the equation

$$y_j = \alpha \left[1 + (\delta - 1) \exp(-\kappa(x_j - \gamma)) \right]^{\frac{1}{1-\delta}} \quad \delta \neq 1$$

where α is the upper asymptote, γ is the location of the point of inflection on the x axis, κ is a scaling factor, and δ is a parameter that indirectly locates the point of inflection.

The y -ordinate of the point of inflection is determined from

$$\frac{\alpha}{\delta^{1/(\delta-1)}} \quad \delta > 0$$

Richards also derived the average normalized growth rate for the curve as

$$\frac{\kappa}{2(\delta+1)}$$

The following constraints apply to the fit coefficient values:

- $\alpha > 0$, $\gamma > 0$, $\kappa > 0$, $\delta > 0$
- $\alpha > \gamma$
- $\delta \neq 1$

Finally, the response feature vector \mathbf{g} for Richards family of growth curves is defined as

$$\mathbf{g} = \left[\alpha \quad \gamma \quad \kappa \quad \frac{\kappa}{2(\delta+1)} \right]^T$$

Weibul Growth Curve

The Weibul growth curve is defined by the equation

$$y_j = \alpha - (\alpha - \beta) \exp\left(-\left(\frac{\kappa x_j}{\delta}\right)^\delta\right)$$

where α is the value of the upper curve asymptote, β is the value of the lower curve asymptote, κ is a scaling parameter, and δ is a parameter that controls the x-ordinate for the point of inflection for the curve at

$$\left(\frac{1}{\kappa}\right)\left(\frac{\delta-1}{\delta}\right)^{1/\delta}$$

The following constraints apply to the curve fit parameters:

- $\alpha > 0, \beta > 0, \kappa > 0, \delta > 0$
- $\alpha > \beta$

The associated response feature vector is

$$\mathbf{g} = \left[\alpha \quad \beta \quad \kappa \quad \delta \quad \left(\frac{1}{\kappa}\right)\left(\frac{\delta-1}{\delta}\right)^{1/\delta} \right]^T$$

Exponential Growth Curve

The exponential growth model is defined by

$$y_j = \alpha - (\alpha - \beta) \exp(-\kappa x_j)$$

where α is the value of the upper asymptote, β is the initial size, and κ is a scale parameter (time constant controlling the growth rate). The following constraints apply to the fit coefficients:

- $\alpha > 0, \beta > 0, \kappa > 0$
- $\alpha > \beta$

The response feature vector \mathbf{g} for the exponential growth model is defined as

$$\mathbf{g} = [\alpha \quad \beta \quad \kappa]^T$$

Gompertz Growth Model

Another useful formulation that does not exhibit a symmetric point of inflection is the Gompertz growth model. The defining equation is

$$y_j = \alpha \exp\left(-e^{-\kappa(j-\gamma)}\right)$$

where α is the final size achieved, κ is a scaling factor, and γ is the x-ordinate of the point of inflection. The corresponding y-ordinate of the point of inflection occurs at

$$\frac{\alpha}{e}$$

With maximum growth rate

$$\frac{\kappa\alpha}{e}$$

The following constraints apply to the selection of parameter values for the Gompertz model:

$$\alpha > 0, \kappa > 0, \gamma > 0$$

The response feature vector g for the Gompertz growth model is defined as

$$g = \left[\alpha \quad \gamma \quad \kappa \quad \frac{\kappa\alpha}{e} \right]^T$$

Local Model Class: Linear Models

Select **Linear Models** and then click **Setup**.

You can now set up polynomial or hybrid spline models. The settings are exactly the same as the global linear models.

These models are for multiple input factors - for single input factors you can use a different polynomial model from the Local Model Class list, where you

can only change the polynomial order. See “Local Model Class: Polynomials and Polynomial Splines” on page 5-5.

If there is more than one input factor, you can choose Linear Models from the Local Model Class list, then you can choose Polynomial or Hybrid Spline. This polynomial is a different model where you can change more settings such as Stepwise, the Term Editor (where you can remove any model terms) and you can choose different orders for different factors (as with the global level polynomial models).

See “Global Linear Models: Polynomials and Hybrid Splines” on page 5-66 for details.

Note that by default inputs are transformed to $[-1, 1]$ before fitting and evaluating polynomials. This is important as differences in scales between inputs can cause numerical problems. Generally it is a good idea to transform inputs as this alleviates problems with variables of different scales. In some circumstances you may be concerned with the values of polynomials (for example if your strategy requires raw polynomial coefficients). In this case you can clear the **Transform input range** check box to use untransformed units to calculate natural polynomials.

Different response features are available for this Linear Models: Polynomial model and the other Polynomial choice (for single input factors). You can view these by clicking the **Response Features** tab on the Local Model Setup dialog box. Single input polynomials can have a datum model, and you can define response features relative to the datum. See “Datum Models” on page 5-88.

These linear models are labeled Quadratic, Cubic, and so on, on the test plan block diagram, while the single input type of polynomials is labeled Poly2, Poly3, and so on. For higher orders, both types are labeled Poly n .

Local Model Class: Average Fit

You can use this local model class to fit the same model to all tests. Sometimes it is desirable to try to fit a single one-stage model to two-stage data (for example, fitting an RBF over the whole operating region of spark, speed, load, air/fuel ratio and exhaust gas recirculation). However, it can still be useful to be able to examine the model fit on a test-by-test basis. You can use Average Fit for this purpose.

Select **Average Fit** and click **Setup**. The Model Setup dialog box appears.

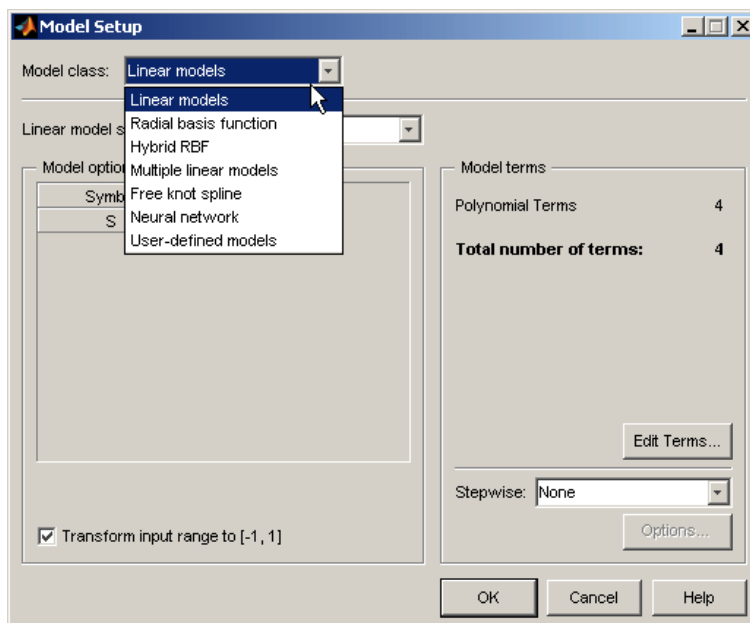

In the **Model class** drop-down menu is a list of available models. This list contains the same models that you would find in the global model setup of a one-stage model. Note the number of inputs changes which models are available. A local model with only one input can access all the models seen in the example above. See “What Models Are Available?” on page 5-2.

The Average Fit local model class allows you to use any of these global model options to fit to all tests. In the same way that global models are fitted to all the data simultaneously, using average fit allows you to fit the same model to every test in your data, instead of fitting a separate local model for each test.

The advantage of this is that you can use these one stage models to fit your data while also being able to view the fit to each test individually. You should set up your global model with an input such as record number or a dummy variable. Make all the variables you want to model local inputs. It does not matter what dummy variable or model type you use for the global input - it is only there to distinguish the Local Average Fit model from a one-stage

model. The dummy global variable has no influence on the model fit. The Average Fit model is fitted in the same way as a one-stage model (across all tests simultaneously) but the main difference is that you can analyze the fit to each test individually. You cannot perform such analysis when fitting one-stage models.

Note No two-stage model is available with local Average Fit models, and you cannot use covariance modeling.

Local Model Class: Multiple Models

You can use multiple models to try a variety of models for your data. These can be useful if you want to try several kinds of models, especially if you think there is a lot of variation between tests in your data. All the models you choose will be fitted and the best one chosen for each test in your data. In this way you can have a variety of local models at once, for example for some tests a spline or radial basis function may fit best, while for others a quadratic would be fine. You can use any model available as one-stage models (including radial basis functions (RBF) and hybrid RBF). You can choose to use the range of the data for each test, instead of a single range for all. You can choose any of the summary statistics as the selection criteria for deciding which model fits best to each test.

You must have at least one global variable, and *no two-stage or response feature models are constructed*. For more information, see “Use Cases for Point-by-Point Models” on page 1-9.

Local multiple model fits automatically run in parallel if you have Parallel Computing Toolbox™ software and the parallel language worker pool is open.

To set up local multiple models:

- 1 Select **Multiple Models** from the model class menu.

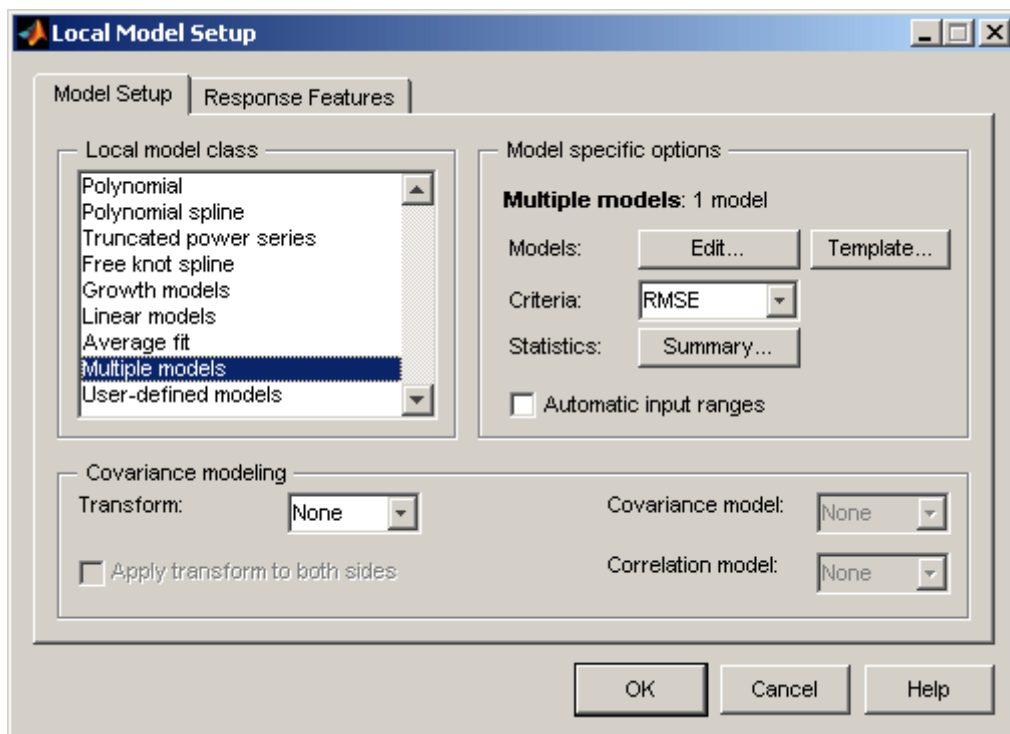

- Click **Edit** to add and change models using the Multi-Model Settings dialog box. This method is similar to the method for using multiple models at the global level, see “Global Model Class: Multiple Linear Models” on page 5-80. Controls are described in step 2.
- Click **Template** to open the “Build Alternative Models to Compare” on page 5-90. In this dialog box, you can choose a template to build a selection of models. There are predefined templates for polynomials, radial basis functions, hybrid radial basis functions, or free knot splines, and you can also save your own templates of any models you choose.
- The **Criteria** you select from the drop-down list of statistics is used to automatically choose the best model type for each test. You can also control the choice of model for each test after the models are fitted, using the **Utilities** submenu in the local model view. See “Analyzing Point-by-Point Models” on page 1-10.

- Click **Summary** to select statistics that appear in the **Diagnostic Statistics Summary Table** in the local model view.
 - Select the check box **Automatic input ranges** to use data-based ranges for each test. Otherwise, the range for every local model is the range you set up in the test plan. Using data-based ranges for each test is helpful when the local input ranges for local tests vary between tests. This option is useful for diesel modeling as often there are a number of inputs at the local level (e.g., main injection timing, pilot injection timing, rail pressure, boost pressure and EGR are common variables). The ranges of these variables vary over the global input space (e.g., torque and speed or fuel and speed). Adjusting the ranges for each test means that the inputs are scaled for modeling leading to better conditioned models.
- 2** Use the Multi-Model Settings dialog box to add and edit model types.

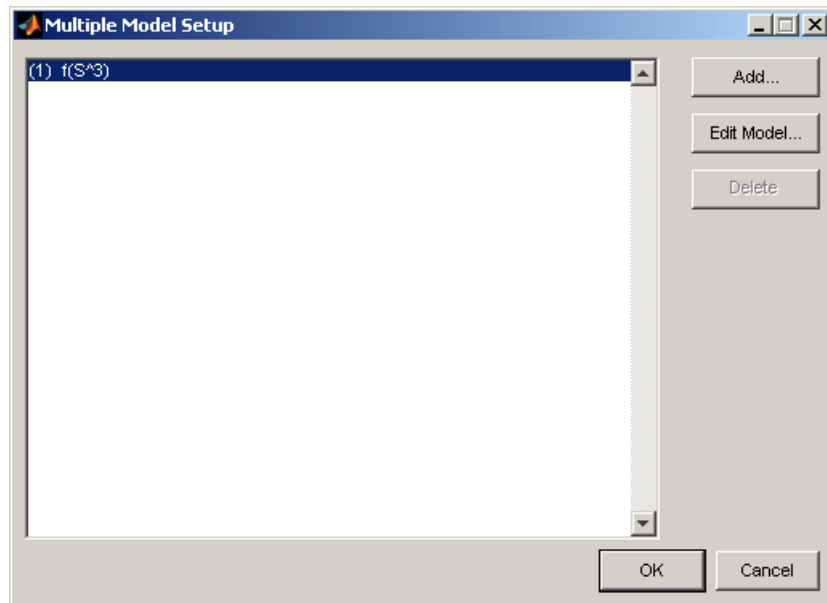

Click **Add** to reach the Model Setup dialog box where you can add a model type. Click **Edit Model** to change the settings for any selected model in the list.

The selection criteria used is the **Criteria** drop-down menu option (such as RMSE or PRESS RMSE) in the Local Model Setup dialog box.

- 3 Use the Model Setup dialog box to choose each model type in turn. In this dialog box, you can choose from all the global models that would be available for a one-stage model with the same number of inputs as your current local model. The following figure shows the options for a single input local model.

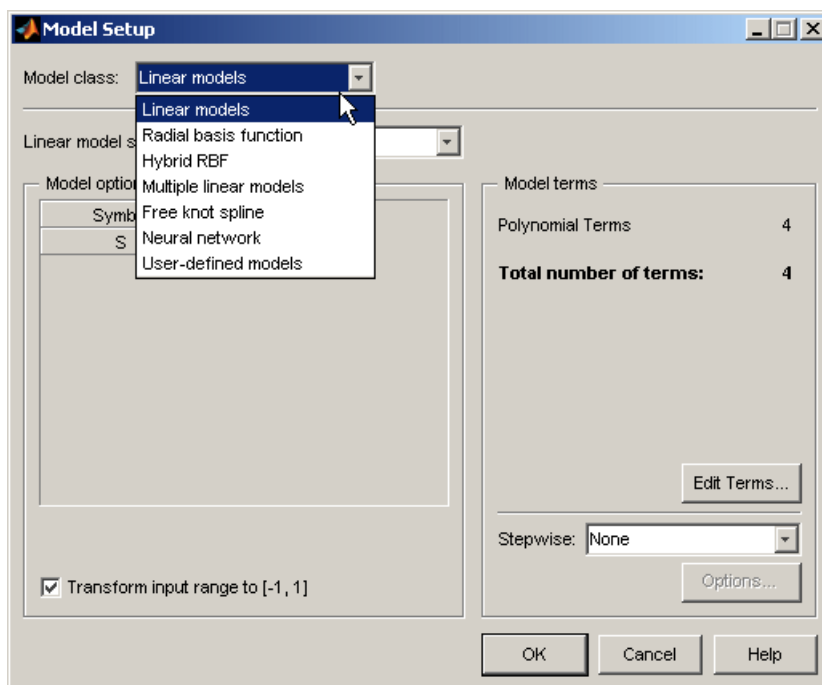

You can choose and set up these models using the same global model options. Click **OK** to add the model to your Multi-Model and return to the Multi-Model Settings dialog box.

After you add the required models to your list and dismissed the dialog boxes, all the models you have chosen are fitted to each test individually, and the best fit to each test is chosen by the selection criteria you picked.

For more information on what you can do with local multiple models, including modeling tools for creating, analyzing and exporting multiple models to CAGE for optimized calibration, see “Set Up a Point-by-Point Model” on page 1-7.

Local Model Class: User-Defined Models

You can create user-defined models to use for local, global or one-stage models.

The user-defined model type allows you to define your equation in a file to use for fitting in the toolbox.

To create and check in a user-defined model:

- 1 Copy the user-defined template file (`functemplate.m`) to a location on the MATLAB path (but not under `matlabroot\toolbox\mbc`). Find the file at this location:

```
<matlabroot>\toolbox\mbc\mbcmodels\@xregusermod\functemplate.m
```

- 2 Modify the copy of the template file for your model. You must code all the compulsory functions. The template comments describe all the compulsory and optional functions.

It is not compulsory to modify every optional section. If you do not wish to use an optional section, leave it unmodified.

- 3 Check your model into the toolbox with this command:

```
m = checkin(xregusermod, 'MfileName', TestInputData)
```

Note Your user-defined models can have as many factors as you choose.

After you check in your user-defined models, they appear as options on the Model Setup dialog box when you are using data with the right number of factors.

To remove your checked-in model from the toolbox, enter:

```
remove(xregusermod, 'MfileName')
```

Note If any of your global models are user-defined you cannot use MLE (maximum likelihood estimation) for your two-stage model.

You can examine this example user-defined model file as a guide:

```
<MATLAB root>\toolbox\mbc\mbcmodels\@xregusermod\weibul.m
```

This file defines the local model Weibul (Growth Model) in the toolbox and hence should not be changed. Make sure you do not overwrite the file. If you alter the file, save it under another name.

The following sections explain how to examine and check in the Weibul model:

- “Examine the Example User-Defined Model” on page 5-27
- “Check the Model into the Toolbox” on page 5-33
- “Verify That the Model Is Checked In” on page 5-33
- “Recover from Editing Errors” on page 5-34

Examine the Example User-Defined Model

This example demonstrates how to create a user-defined model for the Weibul function:

$$y = \alpha - (\alpha - \beta) \cdot \exp(-(\kappa \cdot x)^\delta)$$

1 Open the following example file

```
<MATLAB root>\toolbox\mbc\mbcmodels\@xregusermod\weibul.m
```

Observe that the file is called by the toolbox using

```
varargout= weibul(m,x,varargin)
```

Where the variables are given by

m = the xregusermod object

x = input data as a column vector for fast eval

The first function in the template file is a vectorized evaluation of the function. First, the model parameters are extracted:

```
b= double(m);
```

Then, the evaluation occurs:

```
y = b(1) - (b(1)-b(2)).*exp(-(b(3).*x).^b(4));
```

Note The parameters are always referred to and declared in the same order.

Compulsory Local Functions. You must edit these local functions as follows:

Enter the number of input factors. For functions $y = f(x)$ this is 1.

```
function n= i_nfactors(U,b)
n= 1;
```

Enter the number of fitted parameters. In this example there are four parameters in the Weibul model.

```
function n= i_numparams(U,b)
n= 4;
```

The following local function returns a column vector of initial values (`param`) for the parameters to be fitted. The initial values can be defined to be data dependent; hence there is a flag to signal if the data is not worth fitting (`OK`). In `weibul.m` there is a routine for calculating a data-dependent initial parameter estimate. If no data is supplied, the default parameter values are used.

```
function [param,OK]= i_initial(U,b,X,Y)
param= [2 1 2 5]';
OK=1;
```

Optional Local Functions. You can use the following optional local functions to set additional parameters

- 1** You can state lower and upper bounds for the model parameters. These bounds appear in the same order that the parameters are declared and used throughout the template file.

```
function [LB,UB,A,c,nlcon,optparams]=i_constraints(U,b,varargin)
LB=[eps eps eps eps]';
UB=[1e10 1e10 1e10 1e10]';
```

You can also define linear constraints on the parameters. This code produces the constraint $(-\alpha+\beta)$ is less than or equal to zero:

```
A= [-1 1 0 0];
c= [0];
```

`nlcon` defines the number of nonlinear constraints (here declared to be zero). If the number of nonlinear constraints is not zero, the nonlinear constraints are calculated in `i_nlconstraints`.

```
nlcon= 0;
```

`optparams` defines any optional parameters. No optional parameters are declared for the cost function.

```
optparams= [];
```

- 2** `i_foptions` defines the fit options. The fit options are always based on the input `fopts`. See MATLAB help on the function `optimset` for more information on fit options. When there are no constraints, the toolbox uses the MATLAB function `lsqnonlin` for fitting, otherwise `fmincon` is used.

```
function fopts= i_foptions(U,b,fopts)

fopts= optimset(fopts,'Display','none');
```

- 3** `i_jacobian` can supply an analytic Jacobian to speed up the fitting algorithm.

```
function J= i_jacobian(U,b,x)

x = x(:);
J= zeros(length(x),4);
```

```
a=b(1); beta=b(2); k=b(3); d=b(4);

ekd= exp(-(k.*x).^d);
j2= (a-beta).*(k.*x).^d.*ekd;

J(:,1)= 1-ekd;
J(:,2)= ekd;
J(:,3)= j2.*d./k;
J(:,4)= j2.*log(k.*x);
```

- 4** `i_labels` defines the labels used on plots. You can use LaTeX notation and it is formatted.

```
function c= i_labels(U,b)
c={'\alpha', '\beta', '\kappa', '\delta'};
```

- 5** `i_char` is the display equation string and can contain LaTeX expressions. The current values of model parameters appear.

```
function str= i_char(U,b)

s= get(U,'symbol');
str=sprintf('%.3g - (%.3g-%.3g)*exp(-(%s*x)^{%.3g})',...
    b([1 1 2 3]), detex(s{1}), b(4));
```

- 6** `i_str_func` displays the function definition with labels appearing in place of the parameters (not numerical values).

```
function str= i_str_func(U,b, TeX)

s= get(U,'symbol');
if nargin == 2 || TeX
    s = detex(s)
end
% This can contain TeX expressions supported by HG text objects
lab= labels(U);
str= sprintf('%s - (%s - %s)*exp(-(%s*%s)^{%s})',...
    lab{1},lab{1},lab{2},lab{3},s{1},lab{4});
```

- 7** `i_rfnames` defines response feature names. This example shows a defined response feature that is not one of the parameters (in this case it is also nonlinear).

`rname` does not need to be defined (it can return an empty cell array).

```
function [rname, default] = i_rfnames(U,b)
% response feature names
rname= {'inflex'};

if nargin>1
    default = [1 2 5 4]; %{'Alpha','Beta','Inflex','Delta'};
end
```

- 8** `i_rfvals` defines response feature values. This example defines the response feature labeled as INFLEX in previous step. The Jacobian matrix is also defined here as `dG`.

```
function [rf,dG]= i_rfvals(U,b)
%I_RECONSTRUCT nonlinear reconstruction
%
% p = i_reconstruct(m,b,Yrf,dG,rfuser)
% Inputs
%   Yrf   response feature values
%   dG    Jacobian of response features with respect to
%          parameters
%   rfuser index to the user-defined response features
%          so you can find out which response features
%          are which. rfuser(i) = 0 if the rf is a parameter.
%
% If all response features are linear in model parameters
% then you do not need to define 'i_reconstruct'.

% this is an example of how to implement a nonlinear response
% feature definition

K = b(3);
D = b(4);
if D>=1
    rf= (1/K)*((D-1)/D)^(1/D);
else
```

```

        rf= NaN;
    end

    if nargin>1
        % Jacobian of response features with respect to model
        % parameters
        if D>=1
            dG= [0, 0, -((D-1)/D)^(1/D)/K^2,...
                1/K*((D-1)/D)^(1/D)*(-1/D^2*log((D-1)/D)+...
                (1/D-(D-1)/D^2)/(D-1)];
        else
            dG= [0, 0, 1 1];
        end
    end
end

```

- 9 The `i_reconstruct` local function allows the model parameters to be reconstructed from the response features that have been given. If all response features are linear in the parameters, then you do not need to define this function. The code first identifies which response features (if any) are user defined.

```

function p= i_reconstruct(U,b,Yrf,dG,rfuser)
%I_RECONSTRUCT nonlinear reconstruction
%
% p = i_reconstruct(m,b,Yrf,dG,rfuser)
% Inputs
%   Yrf   response feature values
%   dG    default Jacobian of response features
%   rfuser index to the user-defined response features so you can find
%   out which response features are which. rfuser(i) = 0 if the
%   rf is a parameter.
%
% If all response features are linear in model parameters then you do not
% need to define 'i_reconstruct'.

% reconstruct linear response features using this line
p= Yrf/dG';

% find which response feature is a nonlinear user-defined response feature
f= rfuser>size(p,2);

```

```

if ~any(rfuser==3)
    % need to use delta (must be > 1) for reconstruction to work
    p(:,4)= max(p(:,4),1+16*eps);

    p(:,3)= ((p(:,4)-1)./p(:,4)).^(1./p(:,4))./Yrf(:,f);
end

```

Check the Model into the Toolbox

After you create a user-defined model file, save it somewhere on the path.

You must *check in* the model. The check in process ensures that the model you have defined provides an interface that allows the toolbox to evaluate and fit it. If the checkin procedure succeeds, the toolbox registers the model and is makes it available for fitting when you use appropriate input data.

At the command line, with the example file on the path, you need to create a model and some input data, then call `checkin`. For the user-defined Weibul function, call `checkin` with the example model, its name, and some appropriate data.

```
checkin(xregusermod, 'weibul', [0.1:0.01:0.2]');
```

This returns some command-line output, and a figure appears with the model name and variable names displayed over graphs of input and model evaluation output. The final command-line output (if `checkin` is called with a semicolon as above) is

```

Model successfully registered for
Model-Based Calibration Toolbox software.

```

Verify That the Model Is Checked In

To verify a user-defined model is checked in to the toolbox:

- 1 Start the Model Browser and load data that has the necessary format to evaluate your user-defined model.
- 2 Set up a Test Plan with N Stage1 input factors, where N is the number of input factors defined in `i_nfactors`.

- 3 Open the Local Model Setup dialog box, and select **User-defined models** in the Local Model Class list. Your user-defined model should appear in the right list.

To verify that the `weibul` example user-defined model is checked in:

- 1 Open `gasoline_project.mat`, and select the PS22 test plan node in the tree.
- 2 Double-click the Local Model icon in the test plan diagram.
- 3 In the Local Model Setup dialog box, select **User-defined models** in the Local Model Class list. The `Weibul` user-defined model appears in the right list, as checked in.

Recover from Editing Errors

If you modify the file that defines a checked-in model that you are currently using, the Model Browser tries to continue.

If the user-defined model has serious errors (e.g., you have altered the number of inputs or parameters, model evaluation, or the file cannot be found), the Model Browser changes the status of the current model to 'Not fitted'.

To recover from this state, first correct the problem in the file. Then (for Local Models) you can select **Model > Fit Local** to refit. You do not need to check the model in again, but if you have problems the error messages produced during a checkin may be useful in diagnosing faults.

If there is a minor fault with the file, then the Model Browser continues, using default values. Minor errors can include items such as label definitions, e.g., faults in `i_char`, `i_label`, `i_str_func`, or `i_foptions`. A message appears in the command window providing details of these faults.

Local Model Class: Transient Models

Transient models can be used for local, global or one-stage models. The toolbox support transient models with multiple input factors where time is one of the factors. You can define a dynamic model using Simulink software and an file that describes parameters to be fitted in this model. The toolbox provides an example called `fuelPuddle` which is already checked in to the toolbox. You can use this example for modeling. The example provided requires two input factors. The process of creating and checking in your own transient models is described in the following sections using this example.

- “Create Folders” on page 5-35
- “Create Simulink Model” on page 5-36
- “Create a User-Defined Transient Model File” on page 5-38
- “Compulsory Local Functions” on page 5-38
- “Optional Local Functions” on page 5-40
- “Check In to Toolbox” on page 5-40
- “Using and Removing Transient Models” on page 5-41

Locate the example Simulink model:

```
<MATLAB root>\toolbox\mbc\mbcsimulink\fuelPuddle
```

and the example user-defined transient model file:

```
<MATLAB root>\toolbox\mbc\mbcmodels\@xregtransient\fuelPuddle.m
```

Create Folders

You can define a dynamic model using a Simulink model and a user-defined transient model file that describes parameters to be fitted in this model. You must create folders for these files that are on the MATLAB path. Then, you must check the files into the Model-Based Calibration Toolbox product before you can use them for modeling.

- 1 Create a new folder and add it to the MATLAB path.

For example: `D:\MyTransient`.

Put your Simulink model in this folder. See “Create Simulink Model” on page 5-36.

- 2 Inside the new folder, create a folder called `@xregtransient`. (e.g., `D:\MyTransient\@xregtransient`). You *must* call this folder `@xregtransient`.

Put your user-defined transient model file in the new `@xregtransient` folder. This file must have the same name as your Simulink model. See “Create a User-Defined Transient Model File” on page 5-38.

Create Simulink Model

Create a Simulink model to represent your transient system.

Simulink inports represent the model inputs. Time is the first input to the model in Model-Based Calibration Toolbox software, but it is not an inport in the model. The model output is represented by a Simulink output. Only *one* scalar output is supported in the Model Browser.

Your Simulink model must have some free parameters that Model-Based Calibration Toolbox software will fit by nonlinear least squares. The same variable names used in the model must also be used in the user-defined transient model file.

The Simulink model for the `fuelPuddle` example appears in the following figure. You will examine the example file (`fuelPuddle.m`) in a later section.

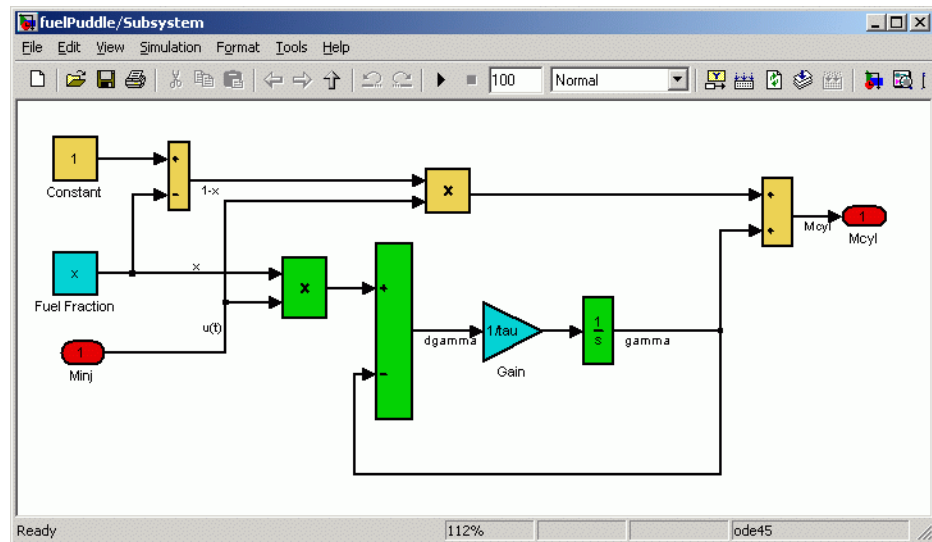

The block labels are not important. The model returns a single scalar output (here labeled “Mcy1”).

The toolbox defines the model parameters in the Model Workspace. You can see this in the Model Explorer. A vector of all parameters called p is also available.

Model Requirements. For both continuous and discrete models, the following rules apply:

- For Simulink models with a Fixed Step solver the step size is set to the sample time of the data.
- For Variable step solvers the simulation step size is set by the Simulink model.
- You see an error if the size of the output from simulating the Simulink model does not match the size of the input data provided by the toolbox.

Create a User-Defined Transient Model File

You must define a transient model file for your Simulink model, and this file must have the same name as your Simulink model.

- 1 Copy the transient model template file, found at:

```
<MATLAB root>\toolbox\mbc\mbcmodels\@xregtransient\functemplate.m
```

Copy the file to the new *MyTransientFolder*\@xregtransient folder you created.

- 2 Modify the copy of the template file for your model.

The commented code describes the compulsory and optional functions available in the template file.

You do not have to modify every section. If you do not want to use an optional section, leave it unmodified, and the defaults will be sufficient.

Open the example file `fuelPuddle.m` (for the `fuelPuddle` model) to examine the code described in the following sections. Find the file here:

```
<MATLAB root>\toolbox\mbc\mbcmodels\@xregtransient\fuelPuddle.m
```

Compulsory Local Functions

You must specify the following local functions:

- 1 Specify the parameters of the Simulink model that will be fitted.

```
function vars= i_simvars(m,b,varargin);  
vars = {'tau','x'};
```

This local function must return a cell array of strings. These are the parameter names that the Simulink model requires from the workspace. These strings *must* match the parameter names declared in the Simulink model.

- 2 If your Simulink model requires constant parameters to be defined, do so here:

```
function [vars,vals]= i_simconstants(m,b,varargin);
vars = {};
vals = [];
```

These are constant parameters required by the Simulink model from the workspace, and are not fitted. These parameters must be the same as those in the Simulink model, and all names must match. Here `fuelPuddle` requires no such parameters, and hence we return an empty cell array and empty matrix.

3 Specify Initial conditions for the integrators.

```
function [ic]= i_initcond(m,b,X);
ic=[];
```

Initial conditions are based on the current parameters, and inputs could be calculated here. Leaving `ic = []` means that Simulink uses the definition of initial conditions in the Simulink model.

4 Specify the number of input factors, including time.

```
function n= i_nfactors(m,b);
n= 2;
```

Time is the first input for transient models. `fuelPuddle` has the input `X = [t, u(t)]`, and so the number of input factors is 2.

5 This local function returns a column vector of initial values for the parameters that are to be fitted.

```
function [b0,OK]= i_initial(m,b,X,Y)
b0= [0.5 0.1]';
OK=1;
```

You must check `nargin` before using `X` and `Y` as this local function is called with 2 or 4 parameters: `(m,b)` or `(m,b,X,Y)`.

You could do some calculations here to estimate good initial values from the `X`, `Y` data. The initial values can be defined to be data dependent, hence there is an `OK` flag to signal if the data is not worth fitting. The example defines some default initial values for `x` and `tau`.

Optional Local Functions

You do not need to edit the remaining local functions unless they are required. The comments in the code describe the role of each function. You use these functions most often when you are creating a user-defined model (see “Local Model Class: User-Defined Models” on page 5-26).

These labels are used on plots:

```
function c= i_labels(m,b)
b= {'\tau','x'};
```

You can use LaTeX notation, and it is correctly formatted. By default, the variable names defined in `i_simvars` are used to specify parameter names.

Check In to Toolbox

Having created a Simulink model and the corresponding function file, you must save each on the path, as described in “Create Folders” on page 5-35.

To ensure that the transient model you have defined provides an interface that allows the toolbox to evaluate and fit it, you *check in* the model. If this procedure succeeds, the toolbox registers the model and makes it available for fitting when you use appropriate input data.

At the command line, with both template file and Simulink models on the path, create some input data, then call `checkin`. The procedure follows.

- 1 Create some appropriate input data. The particular data used is not important; you are using it only to check whether the model can be evaluated.

For the `fuelPuddle` example, enter the following input at the command line:

```
TestInputData = [0:0.1:10; ones(1,101)]';
```

- 2 Call `checkin` with the transient model, its name, and the data. For the example, enter:

```
m = checkin(xregtransient,'fuelPuddle',TestInputData)
```

The string you use for your new transient model name will appear in the Model Setup dialog box when you set up transient models using the appropriate number of inputs.

`xregtransient` creates a transient model object suitable for use in checking in and removing from the toolbox.

A successful checkin creates some command-line output, and a figure appears with the model name and variable names displayed over graphs of input and model evaluation output. The final command line output (if `checkin` is called with a semicolon as in the previous example) is

```
Model successfully registered for
Model-Based Calibration Toolbox software
```

Note You may see errors if you modify the file or model that defines a checked-in transient model that you are currently using in the Model Browser. See “Recover from Editing Errors” on page 5-34.

Using and Removing Transient Models

The `fuelPuddle` model is already checked in for you to use. Open the Model Browser and load data that has the necessary format to evaluate this transient model (two local inputs). Time input data must be increasing.

Create a Test Plan with two local input factors (the same number of input factors required by the `fuelPuddle` model). The Local Model Setup dialog box now offers the following options:

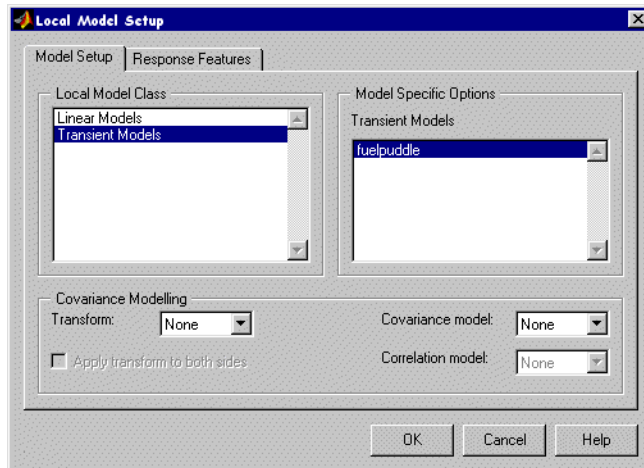

Select the `fuelpuddle` model, and click **OK**.

On building a response model with `fuelPuddle` as the local model, the toolbox fits the two parameters `tau` and `x` across all the tests.

Removing Checked-In Models. To remove a checked-in model, close the Model Browser, and type the following command at the command line:

```
remove(xregtransient, 'ModelName')
```

When you restart the toolbox you will see that this command removes the checked-in transient model.

Covariance Modeling

This frame is visible no matter what form of local model is selected in the list.

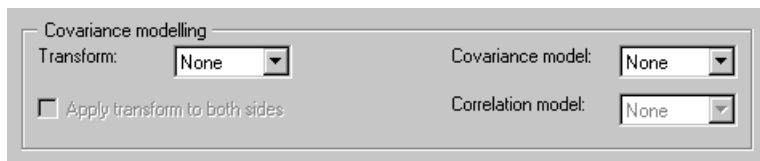

Covariance modeling is used when there is heteroscedasticity. This means that the variance around the regression line is not the same for all values of the predictor variable, for example, where lower values of engine speed have a smaller error, and higher values have larger errors, as shown in the following example. If this is the case, data points at low speed are statistically more trustworthy, and should be given greater weight when modeling. Covariance models are used to capture this structure in the errors.

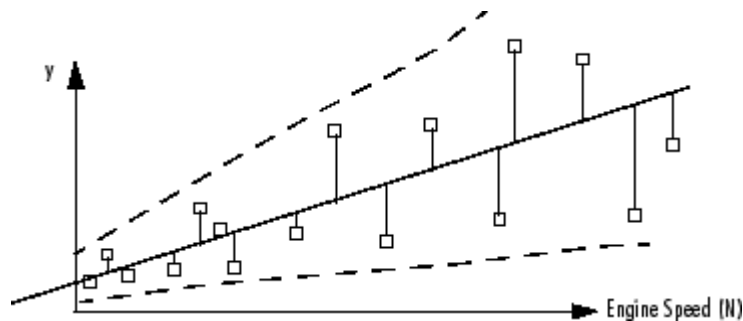

You can fit a model by finding the smallest least squares error statistic when there is homoscedasticity (the variance has no relationship to the variables). Least squares fitting tries to minimize the least squares error statistic

$$\sum \epsilon_i^2, \text{ where } \epsilon_i^2$$

is the error squared at point i .

When there is heteroscedasticity, covariance modeling weights the errors in favor of the more statistically useful points (in this example, at low engine speed N). The weights are determined using a function of the form

$$\sum \frac{\epsilon_i^2}{W_i}$$

where W_i is a function of the predictive variable (in this example, engine speed N).

There are three covariance model types.

Power

These determine the weights using a function of the form $W_i = \hat{y}^\alpha$. Fitting the covariance model involves estimating the parameter α .

Exponential

These determine the weights using $W_i = e^{\alpha \hat{y}}$.

Mixed

These determine the weights using $W_i = \alpha + \hat{y}^\beta$. Note that in this case there are two parameters to estimate, therefore using up another degree of freedom. This might be influential when you choose a covariance model if you are using a small data set.

Correlation Models

These are only supported for equally spaced data in the Model-Based Calibration Toolbox product. When data is correlated with previous data points, the error is also correlated.

There are three methods available.

- MA(1) - The Moving Average method has the form $\varepsilon_n = \alpha_1 \xi_{n-1} + \xi_n$.
- AR(1) - The Autoregressive method has the form $\varepsilon_n = \alpha_1 \varepsilon_{n-1} + \xi_n$.
- AR(2) - The Autoregressive method of the form $\varepsilon_n = \alpha_1 \varepsilon_{n-1} + \alpha_2 \varepsilon_{n-2} + \xi_n$
 ξ is a stochastic input, $\xi_n \sim N(0, \sigma_\xi^2)$.

Transforms

The following example shows the transforms available.

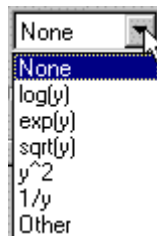

Input transformation can be useful for modeling. For example, if you are trying to fit

$$y = e^{a+bx+cx^2}$$

using the log transform turns this into a linear regression:

$$\log(y) = a + bx + cx^2$$

Transforms available are logarithmic, exponential, square root, y^2 , $\frac{1}{y}$, and Other. If you choose Other, an edit box appears and you can enter a function.

Apply transform to both sides is only available for nonlinear models, and transforms both the input and the output. This is good for changing the error structure without changing the model function. For instance, a log transform might make the errors relatively smaller for higher values of x . Where there is heteroscedasticity, as in the Covariance Modeling example, this transform can sometimes remove the problem.

Boundary Model Setup

In this section...
“About Boundary Models” on page 5-46
“Creating a New Boundary Model” on page 5-48
“Setting Up Local, Global and Response Boundary Models” on page 5-49
“Plotting Boundary Models” on page 5-55
“Combining Best Boundary Models” on page 5-58
“Editing Boundary Model Fit Options” on page 5-61
“Saving and Exporting Boundary Models” on page 5-65

About Boundary Models

From the test plan level, to create and edit boundary models, select **TestPlan > Boundary Models**, or the toolbar button **Edit Boundary Models**. The Boundary Editor appears.

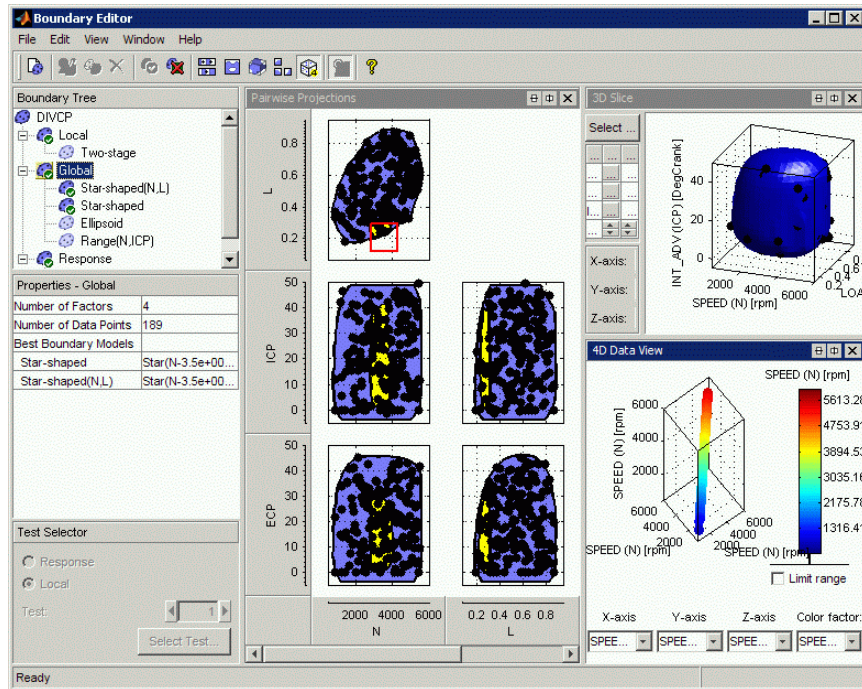

In this editor, you can construct boundary models from your data. *Boundary models* are nonparametric surfaces you can use as a visual aid to understanding complex operating envelopes. You can use boundaries to guide modeling and constrain optimizations.

These boundary models are integrated with the rest of the toolbox functionality. You can view them in the Model Selection window (in the cross section view and response surface view) and in CAGE in optimizations, tradeoff, model views and the Surface Viewer. You can import boundary models into the Design Editor to use as constraints. You can also use them to clip models to view only the area of interest, to constrain models and designs to realistic engine operating envelopes, or to designate the most valid areas for optimization, tradeoff and calibration.

Before you use the Boundary Editor, you should understand how it works to achieve the best results:

- The toolbox saves boundary models implicitly as part of your test plan. Therefore, you do not need to save them separately before closing the Boundary Editor.
- From the Boundary Editor you can export boundary models to Simulink.
- From the Model Browser you can export boundary models with all your other models, from the test plan level. Use the **File** menu to export either to CAGE, to the Workspace or as an exported model file (.exm). See “Export Models to MATLAB, Simulink, and CAGE” on page 6-117.

For local boundary models only, export from the test plan by selecting **TestPlan > Export Point-by-Point Models**.

- You can use the function `ceval` to evaluate a boundary model exported to the Workspace. For example, if your exported model is `M`, then `ceval(M, X)` evaluates the boundary model attached to `M` at the points given by the matrix `X` (values less than zero are inside the boundary). See “Evaluate Boundary Models in the Workspace” on page 6-127 for more details.
- You can import boundary models to use as constraints in the Design Editor.

Creating a New Boundary Model

From the Model Browser test plan level, to create and edit boundary models, select **TestPlan > Boundary Models**, or the toolbar button **Edit Boundary Models**. The Boundary Editor appears.

To create a new boundary model:

- 1** In the Boundary Editor, get started by clicking **New Boundary Model**  in the toolbar, or select **File > New Boundary**.

You cannot access these options for leaf nodes. You can only add new boundary models at the root node and at the second-level nodes (local, global or response).

- 2** For two-stage models, the Choose Level dialog box appears. Select a radio button to specify whether you want to model the boundary of the **Local**, **Global**, or **Response** values, and click **OK**.

Note You can skip this step if you first select the Local, Global or Response nodes in the Boundary Tree and then create a new model. You get a new model appropriate for your current tree selection.

- 3** The controls available depend on the type of boundary model. See “Setting Up Local, Global and Response Boundary Models” on page 5-49.

Setting Up Local, Global and Response Boundary Models

- “What Are Local, Global and Response Boundary Models?” on page 5-49
- “Setting Up Global and Response Boundary Models” on page 5-50
- “Setting Up Local Boundary Models” on page 5-52
- “Adding, Duplicating and Deleting Boundary Models” on page 5-55

What Are Local, Global and Response Boundary Models?

Response boundary models are built to cover the combination of the local and global variable spaces.

Global boundary models are built in the global variable space.

If you only select the global variables as active inputs to model, the differences between a global boundary model and a response boundary model are:

- For the response boundary model, the data includes all records.
- For the global boundary model, the data is one point per test (the average value of the global variables for that test).

Local boundary models fit the boundary of the local inputs. Local boundary models can be either two-stage or point-by-point global evaluation type.

- *Two-stage boundary models* fit the local boundary model parameters as a function of the global inputs. The toolbox uses an interpolating RBF for the function of the global inputs. For example, $\text{min_spark} = f_1(\text{speed},$

load) and $\text{max_spark} = f_2(\text{speed}, \text{load})$. This is useful for modeling borderline spark, for example.

Two-stage boundaries are valid at any operating point.

- *Point-by-point boundary models* are separate boundary models fitted to the data collected at each operating point. Point-by-point boundary models are only valid at the observed operating points. The toolbox uses the global input values are used to select which local boundary model to use.

Setting Up Global and Response Boundary Models

When you set up a **Global** or **Response** boundary model, the Boundary Model Setup dialog box opens, displaying the controls shown in the following figure.

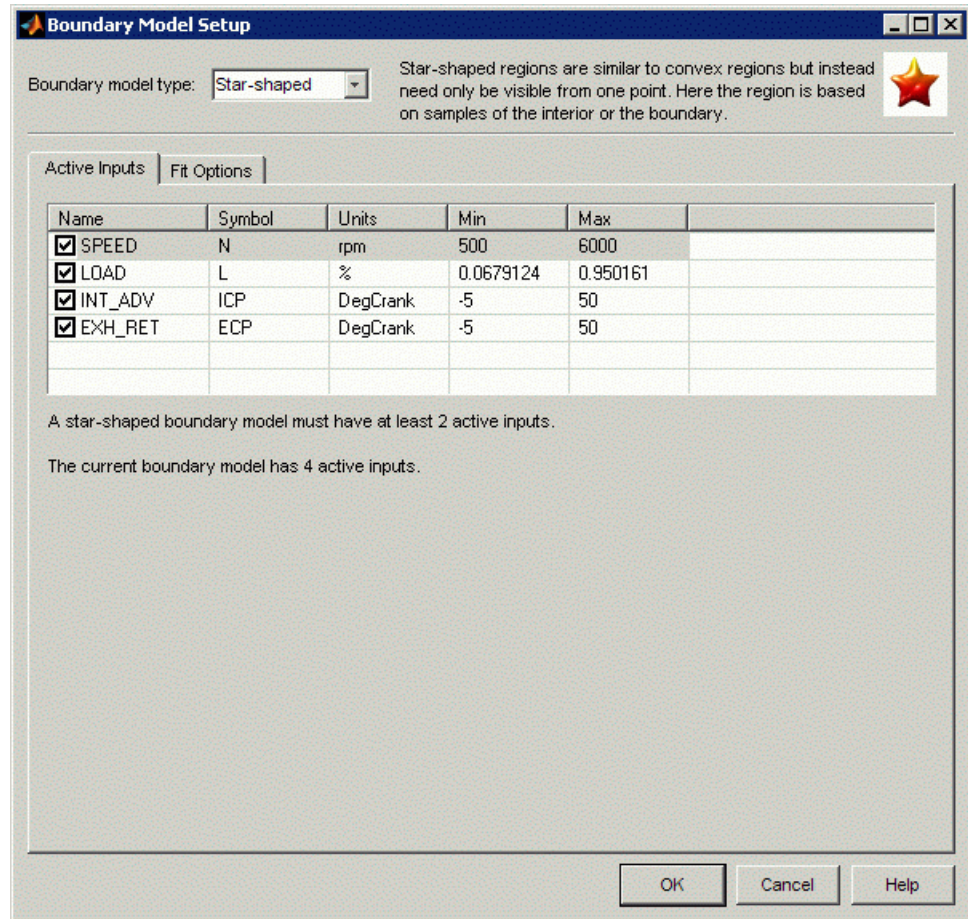

- 1 Select a type of boundary model: Range, Star-shaped, Ellipsoid, or Convex Hull.
 - The Range model finds the furthest extent of points for each variable and draws a hyper-rectangle to enclose all points.
Range is the only type that you can use with only one input.
 - The Ellipsoid model forms an ellipse to enclose all points.
 - The Convex Hull model forms the minimal convex set containing the data points.

- The **Star-shaped** model is a more complex model with various settings that determine how your boundary model is calculated. This calculation occurs in three stages: determining the center of the data; deciding which points are on the boundary, and interpolating between those points. The star-shaped model is the only model type that can fit non-convex regions.
- 2** Select a set of input factors to model using the **Active Inputs** check boxes. The required and selected number of inputs is displayed underneath. You may find it useful to build boundary models using subsets of input factors. You can then combine them for the most accurate boundary. This approach can be more effective than including all inputs.
 - 3** The **Fit Options** tab is only enabled if your selected boundary type has any options you can set.
 - Range models do not have any further settings you can alter.
 - Star-shaped, convex hull, and ellipsoid models have a variety of parameters you can alter, see “Editing Boundary Model Fit Options” on page 5-61. Try the defaults before experimenting with these.
 - 4** Click **OK**, and the toolbox calculates the boundary model.

Setting Up Local Boundary Models

For **Local** boundary models you can set up a two-stage boundary or a point-by-point boundary. When you set up a local boundary model, the Local Boundary Model Setup dialog box opens.

Two-Stage Boundaries. To set up a two-stage boundary model:

- 1** Leave the default setting **Two-stage** in the **Global evaluation** list. You see the following controls.

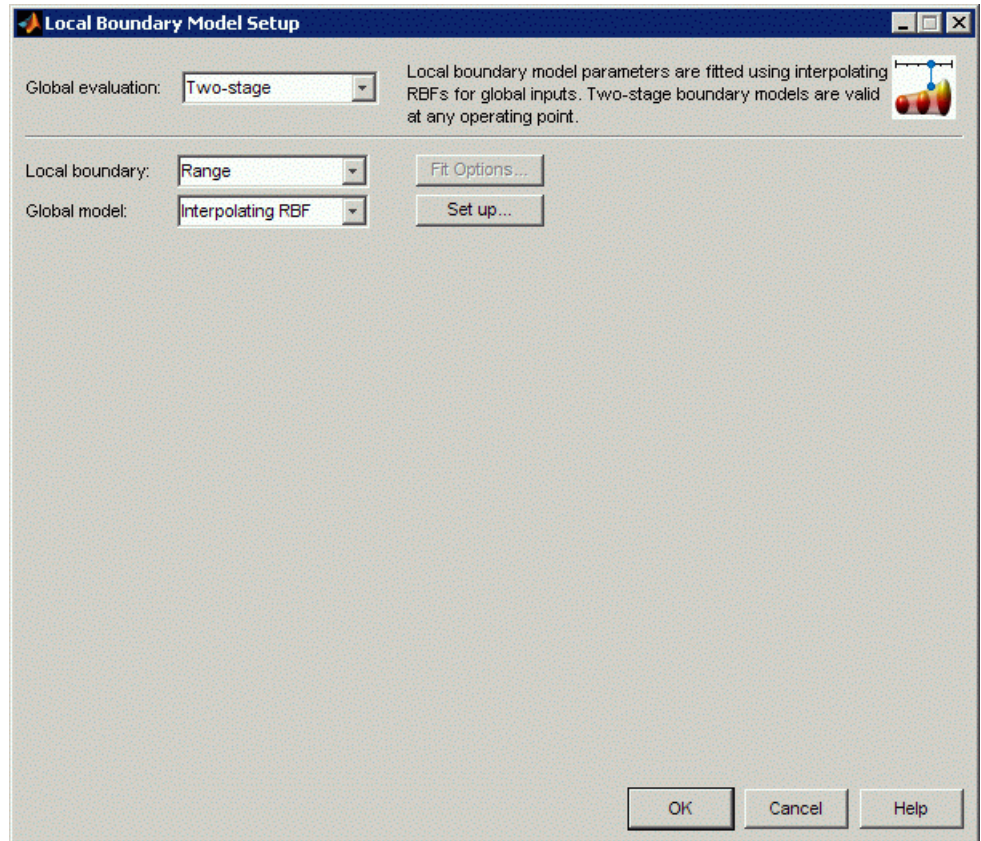

- 2 You can select **Range** or **Ellipsoid** for the **Local Boundary** (to fit to the local inputs).

You can select **Ellipsoid** only for more than one local variable. You can select **Fit Options** only for **Ellipsoid** models. Click **Fit Options** to see the parameters you can alter. Try the defaults before experimenting with these. See “Editing Boundary Model Fit Options” on page 5-61.

- 3 The **Global model** must be an interpolating RBF that interpolates across the global inputs between these local boundaries. You can click **Set Up** to change the parameters for the interpolating RBF.
- 4 Click **OK**, and the toolbox calculates the boundary model.

Point-by-Point Boundaries.

To set up a point-by-point boundary model:

- 1 Select **Point-by-point** in the **Global evaluation** list. You see the controls shown in the following figure.

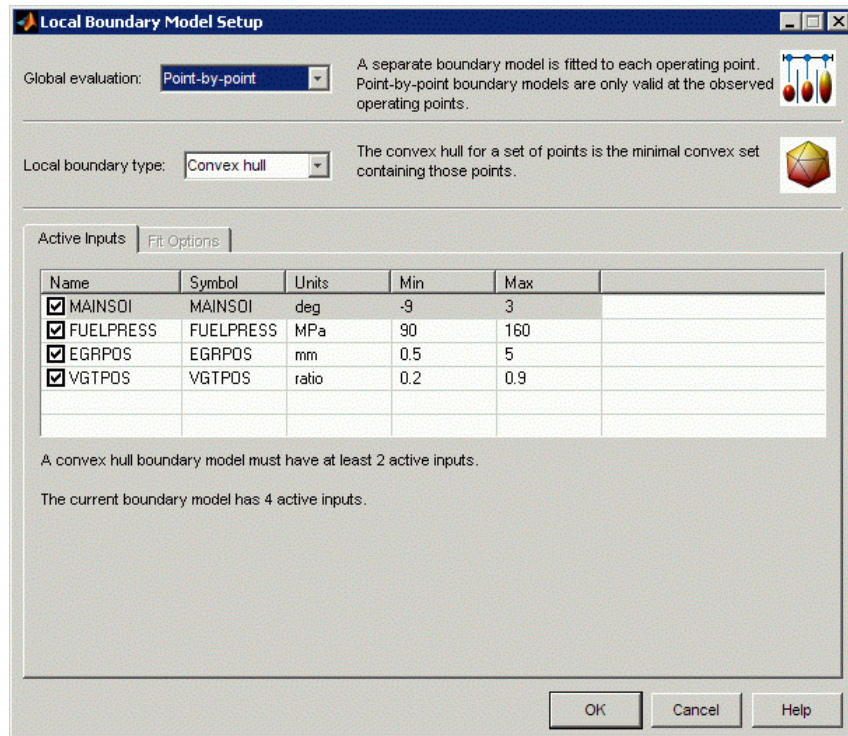



- 2 Select the boundary settings. The available settings for point-by-point boundary models are the same as for global or response boundary models:
 - a Select a **Local boundary type**: Range, Star-shaped, Ellipsoid, or Convex Hull.
 - b Select a set of input factors to model using the **Active Inputs** check boxes.

- c Optionally, view or edit settings on the **Fit Options** tab, if enabled for your boundary type.

See “Setting Up Global and Response Boundary Models” on page 5-50 for more details.

- 3 Click **OK**, and the toolbox calculates the boundary model.

Adding, Duplicating and Deleting Boundary Models

-  New boundary model (also in the **File** menu)— Opens a setup dialog box, and, when you click **OK**, adds a new child node (containing a fitted boundary model) to the current node. This button is not enabled at leaf nodes. Similarly to the model tree in the Model Browser, the new child nodes are different depending on the location of your current selection in the tree.
 - For one-stage test plans, new child nodes of the root (top) node are boundary models (leaf nodes).
 - For two-stage test plans, new child nodes differ depending on the parent node. From the top or root node, you can choose a new child node of either local, global, or response type. From local, global or response nodes, new child nodes are boundary models of the same type as their parent nod — local, global or response. You can add as many boundary models of each type as you want.
- These toolbar buttons are only available for leaf nodes: (also in the **Edit** menu):
 -  Duplicate boundary model — Duplicates the current node.
 -  Delete boundary model — Deletes the current node.

Plotting Boundary Models

Use the following tools to plot and highlight boundary models and points:

-  1-D Slice — Shows a 1-D slice through your model and data. This function also appears in the **View** menu.

- You can select values for variables in the edit boxes. These values determine the point at which the slice through the boundary is plotted.
- You can change the tolerance values in the **Tolerance** edit boxes next to each variable to set the width of the slice. Data points within the tolerances will be displayed with the slice. This display is very similar to the one in the Cross Section model selection view, where the Tolerance either side of the displayed model slice determines how near data points must be to the model slice to be displayed. See “Cross Section View” on page 6-60 for comparison.
- You can click and hold on data points to view the values of the inputs at that point, and the distance from the boundary. Double-click a data point to move the slice view to that point, or click **Select Data Point** to choose a particular point.

-  **2-D View** — Shows a 2-D slice through your model and data. This function also appears in the **View** menu. You can choose which variables to plot on the X and Y drop-down menus. Similarly to the 1-D Slice view, you can change the values and tolerances of the other variables in the edit boxes to determine where the boundary slice is plotted and how much data is also displayed.

You can click and hold on data points to view the values of the inputs at that point, and the distance from the boundary. Double-click a data point to move the slice view to that point, or click **Select Data Point** to choose a particular point.



-  **3-D Slice** — Shows a 3-D slice of your model and data. This function also appears in the **View** menu. You can choose which variables to use for the three axes using the drop-down menus and set the resolution of the grid (number of points) to display in the value edit boxes for each factor. You can set the value of other variables in the edit boxes as for the 2-D view.

You can click and hold on data points to view the values of the inputs at that point, and the distance from the boundary. Double-click a data point to move the slice view to that point, or click **Select Data Point** to choose a particular point.

-  **Pairwise View** — Shows a pairwise projection of your boundary and data. This function also appears in the **View** menu. Clicking this button

displays a plot of the entire range for each pair of variables in turn. You can click and drag to select a region. Do not click on points, instead, click in the blue or white regions and then drag to define a region. The same region is then highlighted in yellow in each projection, so you can see how your data is distributed in each dimension.

Note If some points appear to be outside the boundary, select **View > Set Resolution** to increase the resolution of the pairwise plots. Increasing the number of evaluation points displays more detail, but takes longer to calculate.

-  4–D Data Projection — A 3–D plot of the data points colored by a fourth factor. You can use the drop-down menus to select plot and color bar inputs. This function also appears in the **View** menu.
-  Highlight Boundary Points — Highlights in red all data points that are on the boundary surface. This highlighting applies to all views. The points highlighted red (on the boundary) should have a **Distance** value of zero (distance to the boundary) when you click and hold on these points. Due to rounding errors, the value may not be exactly zero, although it will be very small. This button is only enabled for leaf nodes. Highlight Boundary Points is also in the **View** menu and the right-click context menu on views.
- Highlight Validation Points — If your testplan has validation data, plots all validation data as triangles, and highlights in red all validation points that outside the boundary surface. This highlighting applies to all views. Highlight Validation Points is also in the **View** menu and the right-click context menu on views.
- In the **View** menu:
 - Under **Current View** and **Split View** there are submenus where you can select any of the views available in the toolbar—1D, 2D, 3D slices, the pairwise view, and the 4D data view.
 - You can select graph size (for views with multiple graphs).
 - You can set resolution for the pairwise view.

- You can toggle boundary point highlighting on and off.
- You can split the currently selected view horizontally and vertically, and close the current view, as in the Design Editor and Data Editor.

All these options are available in the right-click context menu on the views.

Combining Best Boundary Models

You can select a single boundary model node as *best* or you can combine models by including them in your best selections. You may find it useful to build boundary models using subsets of inputs and different boundary types. You can then can combine these models to achieve the most accurate boundary. This approach can be more effective than including all inputs.

Note Only models selected as best are exported. You *must* select one or more models as best, or you cannot export boundary models.

Look at the tree icons to see which boundary models are included as best. Included tree nodes have a check mark on their icon. In the following example, Response is included in best, and the child node Star-shaped is not included.



For two-stage or point-by-point test plans, the **Local**, **Global**, and **Response** nodes are included in best by default (even though they are empty to begin with). You can include or exclude any tree node except the root node.



Each parent node displays the combination of child nodes that you have selected as best (if any; otherwise the parent node is empty.) Use the toolbar and **Edit** menu items **Add to Best** and **Remove From Best** to include only the nodes you require at the root node.

For example, if you pick two leaf nodes and select **Add to Best** for each, the parent node shows a combination of the two boundary models. You may want

your final model to combine boundaries of different types, e.g., a star-shaped and a range boundary. You can view the results at the parent node: the combined model is clipped to fit within the ranges defined by both boundaries. You can combine as many leaf nodes as you like.

Note You can always see which boundaries have been combined at the currently selected node by viewing the **Properties** pane.

Use the following toolbar buttons or the **Edit** menu to combine and remove boundary models. These toolbar buttons are not available for the root node (only leaf and second-level nodes).

-  Add to best — Include selected node in best. Only enabled where the selected node is excluded from best.
-  Remove from best — Exclude selected node from best. Only enabled where the selected node is included in best.

You can combine the best models for one-stage or two-stage (local, global and response) leaf nodes.

The **Local** node displays the child node or nodes selected as best (or is empty if none are selected as best). The **Global** and **Response** nodes also display their child node or combination of nodes selected as best. You can only combine local leaf nodes with other local leaf nodes, and global leaf nodes with other global leaf nodes, etc., because you can only have one best model at the **Local** node, one best model at the **Global** node, and one best model at the **Response** node. However you can choose to combine any of the **Local**, **Global**, or **Response** nodes as best for the root node. You can see which child model (or combination) is currently best from a parent node (e.g., **Global**) or the root node by looking under **Best Boundary Model** in the bottom left **Properties** pane.

See the following figure for an example.

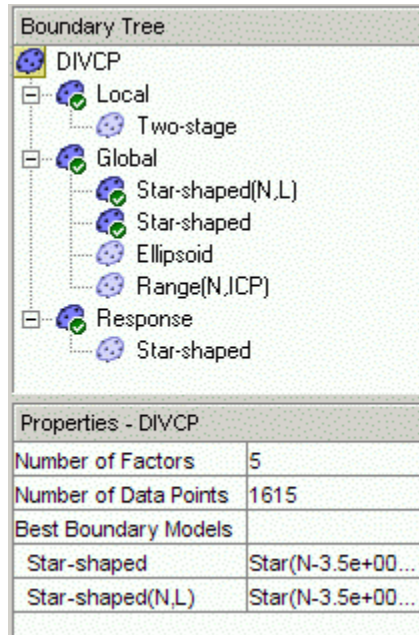

In this example, the root node (DIVCP) is selected—the icon is outlined. Look at the **Properties** pane to see which leaf node (or nodes) you have included in the set of best boundary models for the selected node—in this case, it is **Star-shaped** (all inputs) and the **Star-shaped(N,L)** global nodes. The icons in the rest of the tree show the path of combined nodes.

Looking one level down in the tree, **Local**, **Global**, and **Response** are all included in best, but **Local** and **Response** are empty because they do not contain any child nodes selected as best. The **Local** and **Response** nodes are included in the best selection for the root node, but they have no effect because they are currently empty. Selections at different levels of the tree (branch and leaf) are independent.

Only the **Global** node contains any child nodes included in best, and therefore only that combination of global child nodes selected as best is displayed at the parent node (the root).

The **Global** node has the **Star-shaped** (all inputs) and the **Star-shaped(N,L)** child nodes selected as best. Therefore the **Global** node contains the combination of the **Star-shaped** (all inputs) and the **Star-shaped(N,L)**

boundary models. The **Global** node is included in the best for the root node, so the root node also contains the Star-shaped (all inputs) and the Star-shaped (N,L) boundary models.

Editing Boundary Model Fit Options

To edit settings for existing boundary models, you can reach the Boundary Model Setup dialog boxes by selecting **Edit > Set Up Boundary** or the

equivalent toolbar button, . This action opens the Boundary Model Setup dialog box where you can edit settings for the selected model. The new model is fitted when you click **OK**. You can edit the boundary type and active inputs, and settings where available.

You can view the type and details of the selected boundary model in the Properties pane. This pane displays information about the boundary model such as: number of data points; number of boundary, interior, and exterior points; the type of boundary model and summary of settings (e.g. center point of star). For root and branch nodes, you can see which model or combination of models you have selected as best.

See “Combining Best Boundary Models” on page 5-58 for an example.

You can reach the **Fit Options** settings in the Boundary Model Setup dialog box, either when creating a new boundary model, or when editing an existing boundary model, by selecting **Edit > Set Up Boundary** or the equivalent toolbar button.

The **Fit Options** tab (or button for local boundaries) is only enabled if your selected boundary type has any options you can set.

Range models have no additional settings you can alter.

Star-shaped, convex hull, and ellipsoid models have parameters you can alter, as the following topics describe. Try the defaults before experimenting with these.

Ellipsoid Settings

The ellipsoid boundary has a variety of optimization settings you can alter if you are having problems getting a good fit. Change the display setting to `iter` or `final` to see output messages at the command line during the fit, and try different tolerances or numbers of iterations. For details on these settings see `optimset` in the *MATLAB Reference*.

Convex Hull Setting

The default convex hull boundary model keeps only the most useful facets and can discard around 30% of the facets that contribute only a small amount to the boundary. Discarding these facets is more efficient and includes all the data points within the boundary, with the total volume increasing by around 1%.

If you want the minimal volume at the expense of a much larger number of facets and a larger project file size, select the **Keep All Facets** check box. The total number of facets can be many thousands. In a typical example, using 8 factors and 70 points results in a convex hull with around 35,000 facets.

Star-Shaped Settings

The Star-shaped boundary is a more complex model with various settings that determine how your boundary model is calculated. This determination occurs in three stages: determining the center of the data; deciding which points are on the boundary; and interpolating between those points.

- **Special Points > Center** — This setting is not the same as the Center Selection settings for RBFs, instead, the toolbox uses this setting as the method for determining the center of the boundary model sphere. Think of the boundary model as a deformed sphere. You can choose `Mean`, `Median`, `Mid Range`, `MinEllipse` or `User Defined`. If you select `User Defined`, you can enter a value for each input.
- **Boundary Points** — These settings determine how to decide which points are on the boundary.

Interior — Choose this option to specify that not all points should be on the boundary.

Boundary Only — Places all points on the boundary. This setting can save you time, if this is suitable for your data.

- **Dilation Radius** — If you choose Interior points, then **Dilation Radius** is used to determine which points are on the boundary. The model-fitting calculation expands each point to a sphere until a boundary shape is formed by the intersection of all those spheres. See the next illustration.

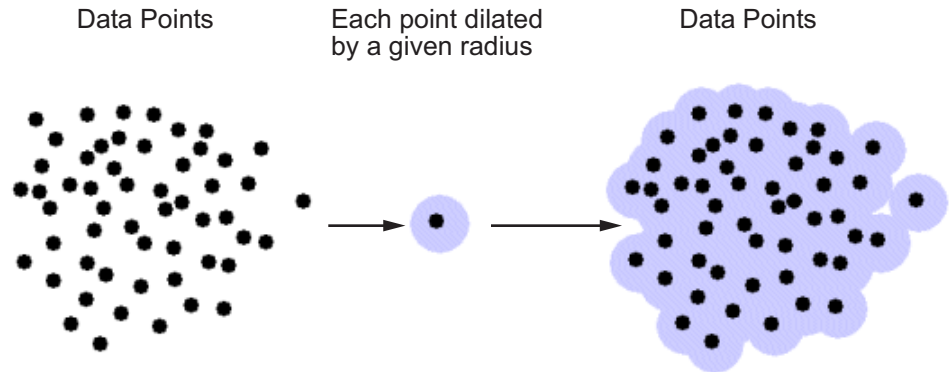

Dilation Radius settings:

- **Auto** — This setting selects the dilation radius (how much to expand each point) by checking all the minimum distances between points, and then choosing the largest of those.
- **Manual** — You can manually set the dilation radius in the edit box. The default is 1. This value may seem large as model range is between -1 and 1, but all points are expanded equally so you will still detect the points on the edge. However, very large spheres will intersect and obscure points that should be detected as boundary points.
- **Ray Casting** — The toolbox draws rays from the center of the boundary model to determine which points are on the edge. The last point intersected on each ray is a boundary point. The ray actually intersects a sphere, given that each point has been expanded by the dilation radius, as the following illustration shows.

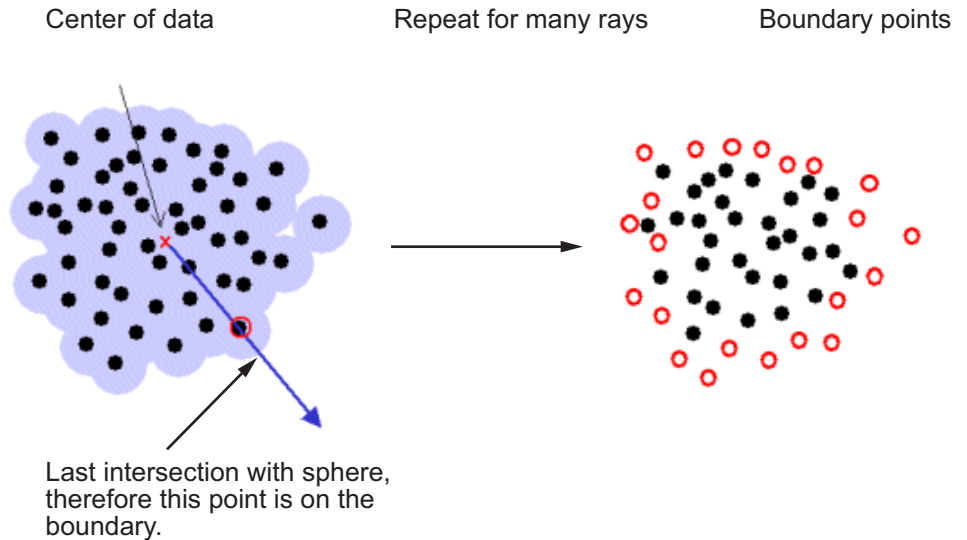

Ray casting settings:

- From **Data** — This option uses the same number of rays as there are data points and sends one ray in the direction of each point. If you have very dense data or a very large number of points it might be better to use the **Manual** setting to choose a smaller number of rays.
- **Manual** — You can set a value in the **Number of Rays** edit box. This number of rays will then be used in random directions. A good guideline is to use about twice the number of data points, although if you have a large number (many hundreds), the model fit becomes very slow, and you may run out of memory. In most situations, more than 1000 is too many.
- **Constraint Fit.**
 - **Transform** — None, Log, or McCallum. The default is None. Depending on the shape of your boundary, you might need to use a transform to prevent self intersections near the center of the model.
 - **RBF Kernel** — Radial Basis Function (RBF) settings. You can choose RBF kernels, width and continuity as when setting up models. See “Global Model Class: Radial Basis Function” on page 5-73 for more information. After the boundary points have been determined, each of those points is used as an RBF center and the toolbox obtains the

boundary surface by interpolating radial basis functions between all those centers. The width and continuity settings depend on which kernel you choose.

▪ **RBF Algorithm**

These options control the interpolating RBF model settings. You can leave the defaults unless you have a very large data set (several thousand points). With very large data sets, you can improve the speed and robustness of fitting if you try a different Algorithm setting, such as GMRES, first and then vary the tolerance and number of iterations.

Saving and Exporting Boundary Models

- **File > Close** — Closes the Boundary Editor and saves your boundary models with the test plan.
- **File > Export to Simulink** — Exports the currently selected node as a block in a Simulink model. If the currently selected node is a leaf node, the toolbox exports a single boundary model. If the selected node is a parent node (root, local, global or response) the toolbox may export one boundary or a combination of several depending on which nodes you have assigned best and added to best.

Global Model Setup

In this section...
“Introducing Global Model Setup” on page 5-66
“Global Linear Models: Polynomials and Hybrid Splines” on page 5-66
“Global Model Class: Radial Basis Function” on page 5-73
“Global Model Class: Hybrid RBF” on page 5-78
“Global Model Class: Interpolating RBF” on page 5-79
“Global Model Class: Multiple Linear Models” on page 5-80
“Global Model Class: Free Knot Spline” on page 5-82
“Global Model Class: Neural Network” on page 5-84
“Global Model Class: User-Defined and Transient Models” on page 5-86

Introducing Global Model Setup

Some global models are only available in the **Model class** list when using the appropriate number of inputs. The example of a user-defined model is for a single input; the example transient model is for two inputs. You can check in your own user-defined models and transient models with as many factors as you choose; these only appear as options when the appropriate number of inputs are present.

See each global model type for details and illustrations of typical model shapes.

See also “Stepwise” on page 5-72, for linear models and radial basis functions.

Global Linear Models: Polynomials and Hybrid Splines

Global linear models can be polynomials or hybrid splines. Options are described in the following sections:

- “Polynomials” on page 5-67

- “Term Editor” on page 5-67
- “Hybrid Splines” on page 5-68
- “Interaction” on page 5-71
- “Stepwise” on page 5-72

Polynomials

Polynomials of order n are of the form

$$\beta_0 + \beta_1x + \beta_2x^2 + \beta_3x^3 \dots \beta_nx^n$$

You can choose any order you like for each input factor.



Quadratic curve

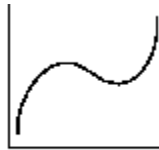

Cubic curve

As shown, a quadratic polynomial $y = ax^2 + bx + c$ can have a single turning point, and a cubic curve $y = ax^3 + bx^2 + cx + d$ can have two. As the order of a polynomial increases, it is possible to fit more and more turning points. The curves produced can have up to $(n-1)$ bends for polynomials of order n .

See also the local model “Polynomials” on page 5-5 for information about different settings available.

Term Editor

Click the **Edit Terms** button to see the terms in the model. This opens the Term Editor dialog box. Here you can remove any of the terms as shown in the following example.

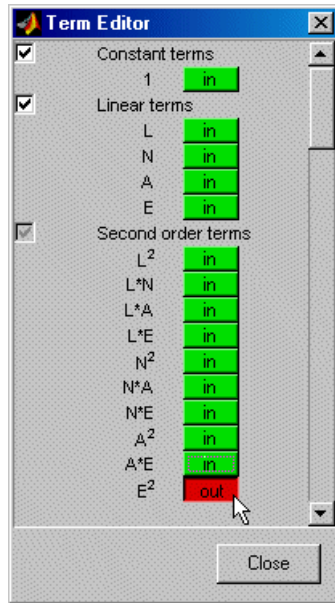

See also “Interaction” on page 5-71.

Hybrid Splines

You can use the Hybrid Spline model to fit a spline to one factor and polynomials to all other factors.

A spline is a piecewise polynomial function, where different sections of polynomials are fitted smoothly together. The locations of the breaks are called knots. You can choose the required number of knots (up to a maximum of 50) and their positions. In this case all the pieces of curves between the knots are formed from polynomials of the same order. You can choose the order (up to 3).

The following example illustrates the shape of a spline curve with one knot and third-order basis functions. The knot position is marked on the N axis.

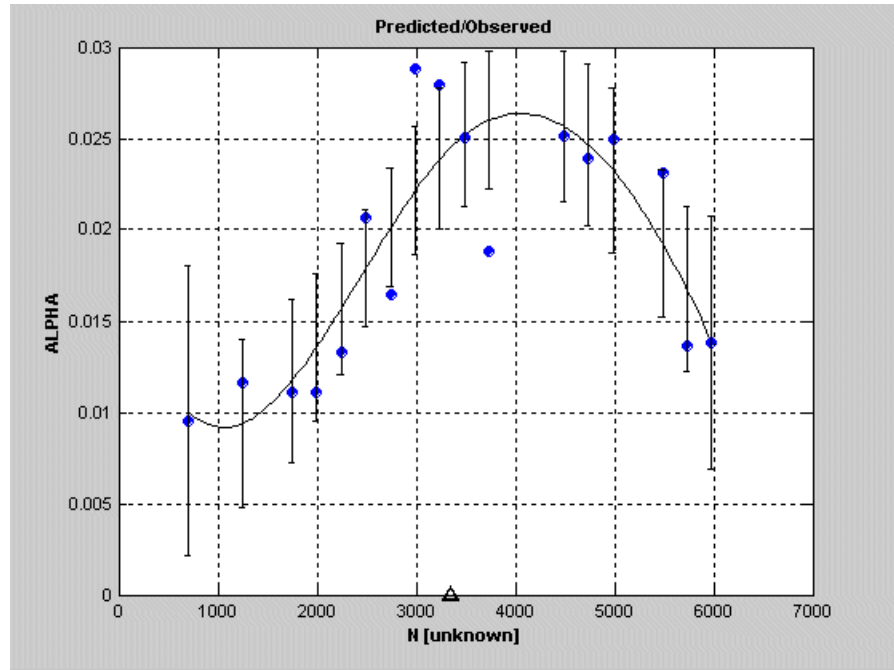

You can fit more complicated curves using splines, so they can be useful for the factor you expect to behave in the most complex way. This allows you to model detailed fluctuations in the response for one factor, while simpler models are sufficient to describe the other factors.

The following example clearly shows that the response (Blow_2 in this case) is quadratic in the Load (L) axis and much more complex in the RPM (N) axis.

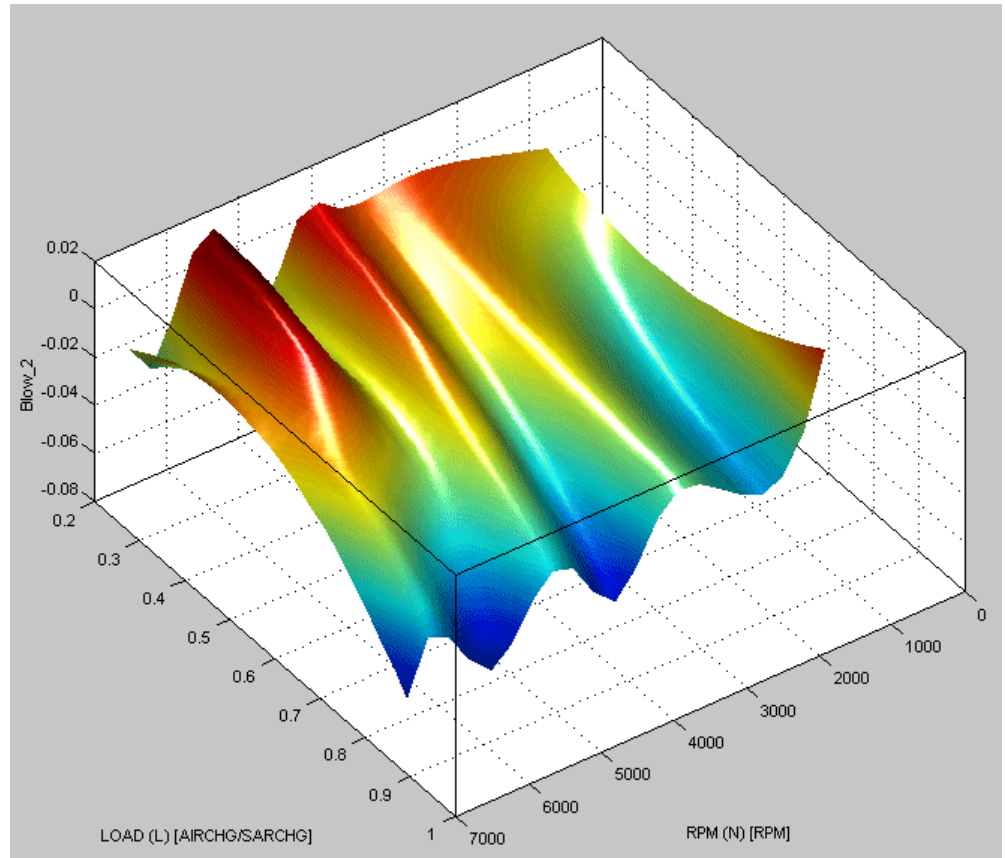

You can choose the order of the polynomial for each factor and the factor to fit the spline to. The maximum order for each factor is cubic. Use the radio buttons to select which factor is modeled with a spline. Select the order for each factor in the edit boxes.

The following example shows the options available for the Hybrid Spline linear model subclass.

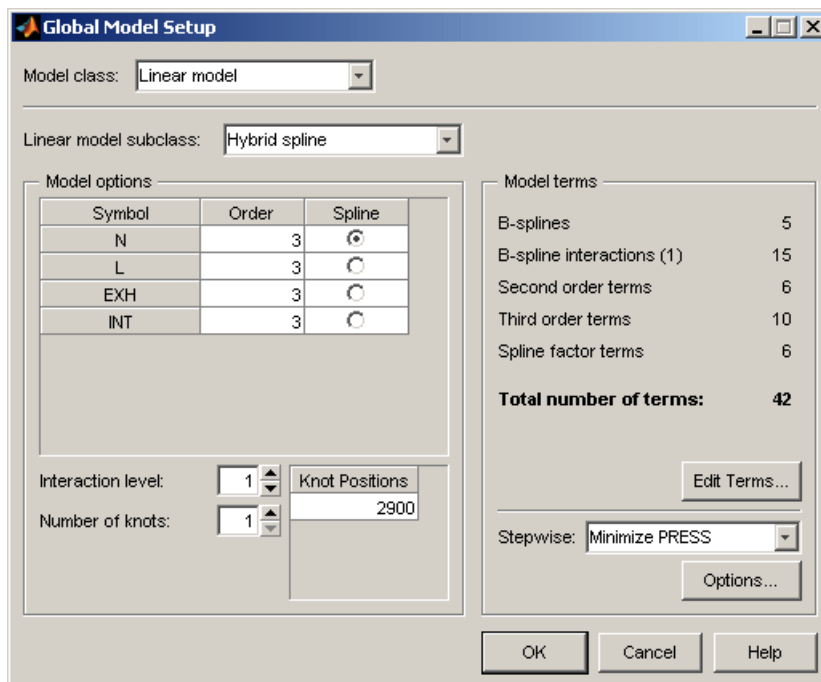

See also “Local Model Class: Polynomials and Polynomial Splines” on page 5-5.

Interaction

You can choose the interaction level on both linear model subclasses (polynomial and hybrid spline). The maximum interaction level is the same as the polynomial order (for example, 3 for cubics).

The interaction level determines the allowed order of cross-terms included.

You can use the Term Editor to see the effects of changing the interaction level. Click the **Edit Terms** button. The number of constant, linear, second- and third-order (and above) terms can be seen in the **Model Terms** frame.

For polynomials. With an interaction level of 1, there are no terms in the model involving more than one factor. For example, for a four-factor cubic, for factor L, you see the terms for L, L^2 , and L^3 , but no terms involving L and other factors. In other words, there are no cross-terms included.

If you increase the interaction level to 2, under second-order terms you see L^2 and also L multiplied by each of the other factors; that is, second-order cross-terms (for example, LN, LA, and LS).

Increase the interaction to 3, and under third-order terms you see L^2 multiplied by each of the other factors (L^2N , L^2A , L^2S), L multiplied by other pairs of factors (LNA, LNS, LAS), and L multiplied by each of the other factors squared (N^2L , A^2L , S^2L). Interaction level 3 includes all third-order cross-terms.

The preceding also applies to all four factors in the model, not just L.

For hybrid splines. The interaction function is different: it refers only to cross-term interactions between the spline term and the other variables. For example, at interaction order 0, raw spline terms only; interaction 1, raw terms and the spline terms x the first-order terms; interaction 2, includes spline terms x the second-order terms; and so on.

Stepwise

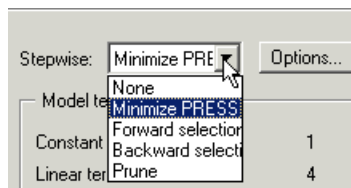

Take care not to overfit the data; that is, you do not want to use unnecessarily complex models that “chase points” in an attempt to model random effects.

The **Stepwise** feature can help. Stepwise will select the terms using various criteria. Stepwise generally means that terms are removed in steps (one at a time). The stepwise algorithms are Minimize Press, Forward Selection, Backwards Selection, and Prune. The most commonly used stepwise

algorithm is **Minimize PRESS**, where at each step the term that will improve the PRESS statistic the most is removed or included. **Minimize PRESS** throws away terms in the model to improve its predictive quality, removing those terms that reduce the PRESS of the model. **Forward and Backwards Selection** uses statistical significance at the alpha % level.

Predicted sum of squares error (PRESS) is a measure of the predictive quality of a model. See “PRESS statistic” on page 6-97 for an explanation of PRESS and “Model Selection Guide” on page 6-64 for more information on why it is useful as a diagnostic statistic.

Prune is one of the alternative algorithms for stepwise. The order of the terms matter, and the terms will only be removed from the end, provided they improve the quality of the fit (measured by various criteria: PRESS, GCV etc.). The other stepwise algorithms do not have this restriction - they can remove any term in any order. Removing terms only from the end is valid when there is ordering in the terms e.g. polynomials (from low order terms to high order terms) or RBFs where the fitting algorithms select the most important terms first.

Click **Options** to open a dialog box containing further settings for the selected **Stepwise** option. You should choose from the list a criteria for removing terms (PRESS, RMSE, AIC, BIC etc.). For the **Prune** settings, see “Global Model Class: Radial Basis Function” on page 5-73. For a guide to all the settings in the Stepwise window (which explains the other Stepwise settings available here), see “Stepwise Regression” on page 6-87. Note you can also use the Stepwise window after model fitting to try other Stepwise settings, and replace excluded model terms if you want.

Global Model Class: Radial Basis Function

A variety of radial basis functions (RBFs) are available in MBC. They are all radially symmetrical functions that can be visualized as mapping a flexible surface across a selection of hills or bowls, which can be circular or elliptical.

Networks of RBFs can model a wide variety of surfaces. You can optimize on the number of centers and their position, height and width. You can have different widths of centers in different factors. RBFs can be useful for investigating the shapes of surfaces when system knowledge is low.

Combining several RBFs allows complicated surfaces to be modeled with relatively few parameters.

The following example shows a surface of an RBF model.

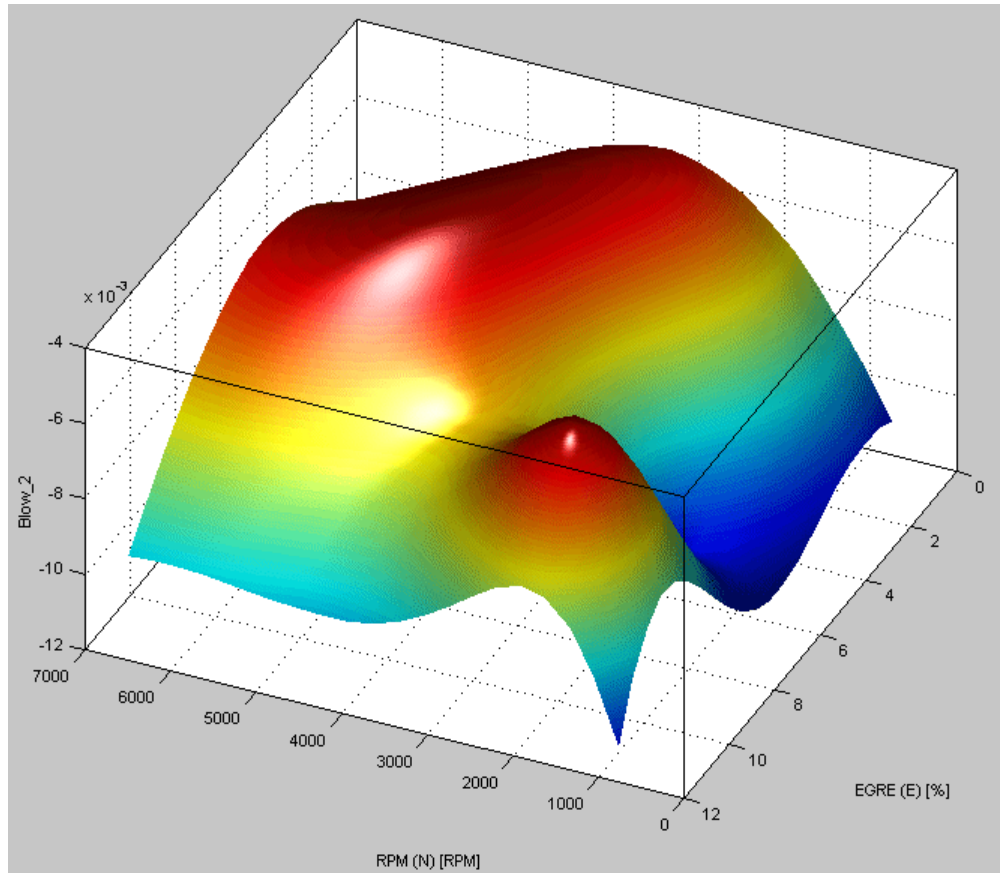

There is a detailed user guide for modeling using RBFs in . See especially “Tips for Modeling with Radial Basis Functions” on page 7-33 for guidelines and “Types of Radial Basis Functions” on page 7-3 for illustrations of different types.

The statistical basis for each setting in the RBF global models is explained in detail in “Radial Basis Functions for Model Building” on page 7-2.

The following example illustrates the basic RBF settings available.

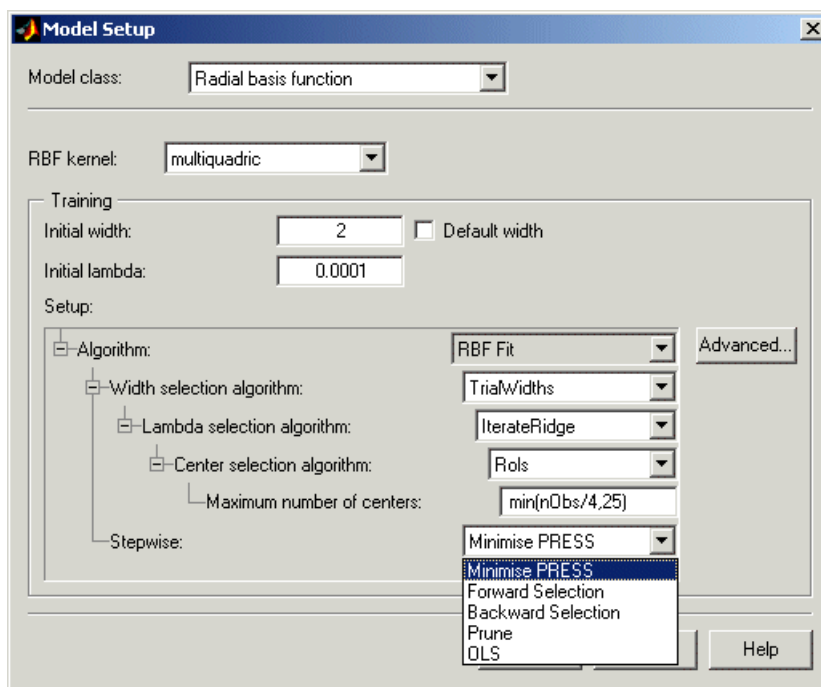

You can use the drop-down menus to set RBF kernel type, initial width and lambda, width, lambda, and center selection algorithm and maximum number of centers. After you have fitted a model once to get some idea of what to expect, you can try different maximum numbers of centers as a useful method for homing in on a good fit. There are more options for fine tuning in the Advanced options dialog box, but you can use the main controls from here to narrow down the search for the best model. See below.

For most algorithms the **Initial width** is a single value. However, for WidPerDim (available in the **Width selection algorithm** pull down), you can specify a vector of widths to use as starting widths. WidPerDim produces elliptical basis functions that can have a different width in each factor

direction. If supplying a vector of widths, there should be the same number as the number of global variables, and they must be in the same order as specified in the test plan. If you provide a single width, then all dimensions start off from the same initial width, but are likely to move from there to a vector of widths during model fitting.

You can use the last drop-down menu to choose to automatically run **Stepwise** at the end of the center/width selection algorithm to remove less useful model terms, Ordinary Least Squares (OLS) or the Prune algorithm to home in on the best number of centers (using your choice of the Summary Statistics as selection criteria).

Note if you choose **Prune** here, there are further settings you need which can be found by clicking **Advanced**. This opens the Radial Basis Function Options dialog box, as shown.

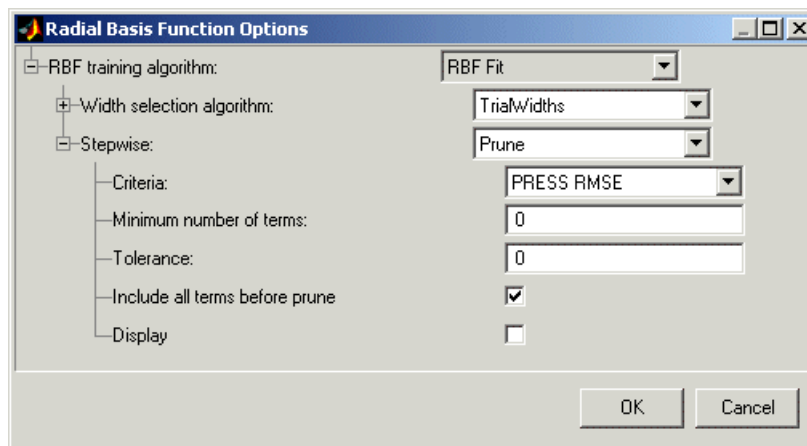

All the settings under **Width selection algorithm** are for fine tuning the RBF model. See “Tips for Modeling with Radial Basis Functions” on page 7-33 for guidelines, and details on specific parameters for different algorithms can be found in “Radial Basis Functions for Model Building” on page 7-2.

The options in the **Stepwise** drop-down menu are the same as the main Model Setup dialog box — Min. PRESS, Forward, Backward, Prune and OLS (Ordinary Least Squares). If you choose **Prune** the further options appear below as shown in this example. You need to choose one of the Summary

Statistics as selection criteria for the Prune algorithm. All the Summary Statistics options are available as criteria, and do not depend on your choices of these statistics in the Summary Statistics dialog box. See “Summary Statistics” on page 6-69 for more information.

We recommend you select the check box to **Include all terms before prune** (otherwise the current number of terms is used at the start). You can choose a **Minimum number of terms**, and the **Tolerance** you set determines how far from this number of terms the algorithm can go — within the limits of the tolerance, the algorithm searches for fewer terms that reduce the value of your selection criteria.

If you select the **Display** check box a figure appears illustrating the Prune process, like the example shown following, plotting the number of parameters against the selection criteria, in this case PRESS RMSE. You can use this information to see if you should change the minimum number of terms and the tolerance and refit, in case you need to avoid a local minimum.

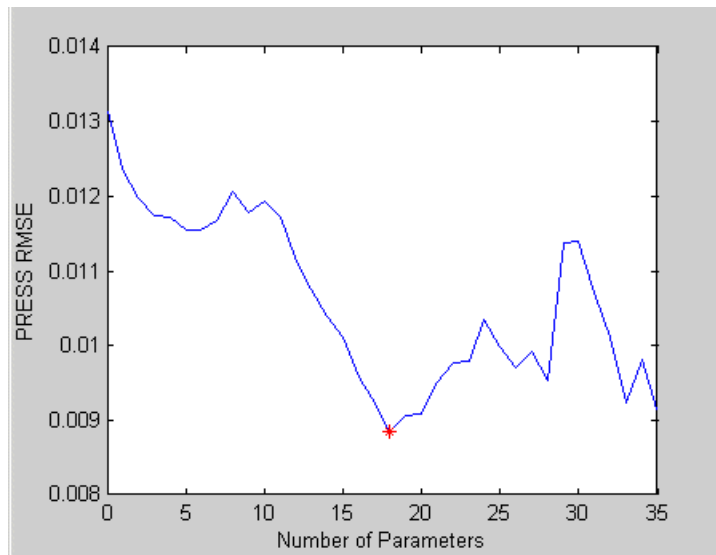

Note Once you have a global model you can use the RBF template in the “Build Alternative Models to Compare” on page 5-90 to automatically build a variety of radial basis function models with varying maximum numbers of centers and/or different kernels.

Global Model Class: Hybrid RBF

This option combines an RBF model with a linear model.

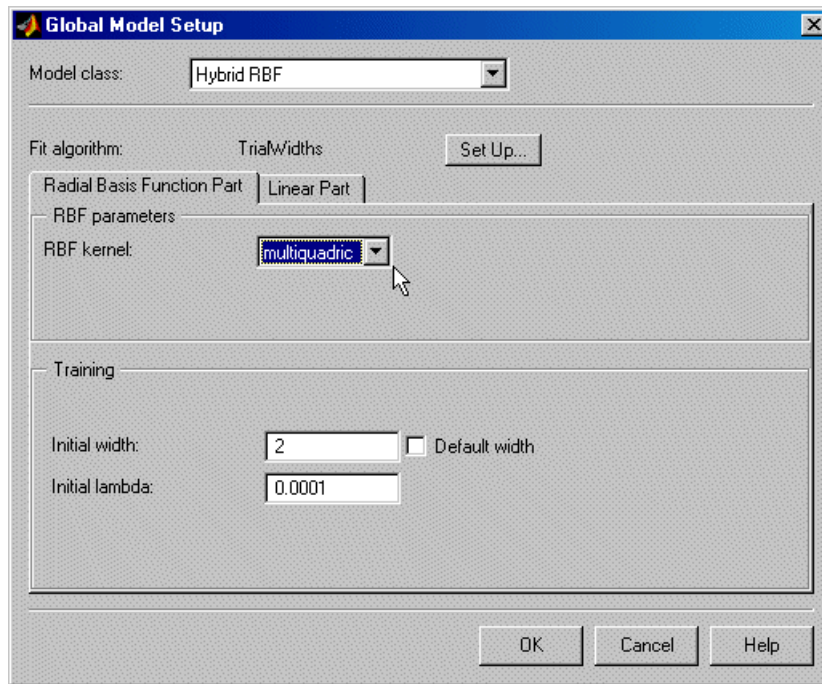

The **RBF kernel** drop-down menu offers the same options as for normal RBF.

The **Linear Part** tab contains the same options as the other global linear models; see “Global Linear Models: Polynomials and Hybrid Splines” on page 5-66.

See “Hybrid Radial Basis Functions” on page 7-31.

Click **Set Up** to reach the Hybrid RBF Options dialog box where you can change all the settings for the RBF part of the model. Here you can also choose to automatically run Stepwise, OLS or Prune. These settings are the same as the Radial Basis Functions Options dialog box, see “Global Model Class: Radial Basis Function” on page 5-73 for details.

See also “Radial Basis Functions for Model Building” on page 7-2 for a detailed guide to the use of all the available RBFs.

Global Model Class: Interpolating RBF

The **Interpolating RBF** model type fits an interpolating surface that passes through every data point. Each point is used as a radial basis function center and the toolbox interpolates RBFs between all those centers. This model type is also used by the Boundary Editor for creating boundary models.

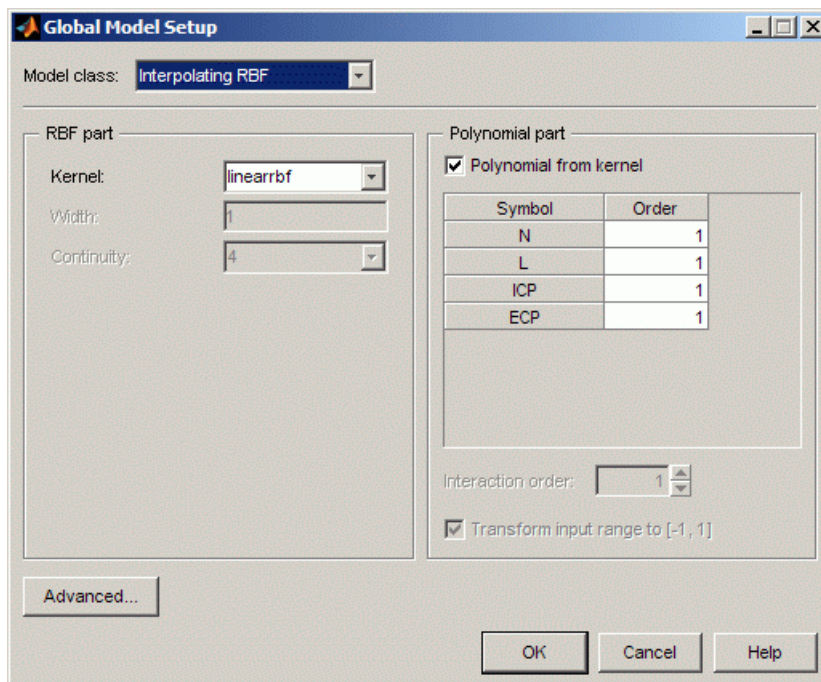

The **Kernel** drop-down menu offers the same options as for normal RBF. The **Width** and **Continuity** parameters are only enabled for specific kernels.

The **Polynomial Part** tab contains the same options as the other global linear models (order and interaction); you cannot edit them unless you clear the check box to create the **Polynomial from kernel**. See “Global Linear Models: Polynomials and Hybrid Splines” on page 5-66.

You can click **Advanced** to reach more interpolating RBF model settings. You can leave the defaults unless you have a very large data set (several thousand points). With very large data sets, you can improve the speed and robustness of fitting if you try a different **Algorithm** setting, such as GMRES, first and then vary the tolerance and number of iterations. The **Algorithm** setting specifies which linear solver to use in solving the linear system of equations for the interpolation.

Global Model Class: Multiple Linear Models

The following example shows the defaults for multiple linear models. You can add linear models (as seen in the single linear model settings).

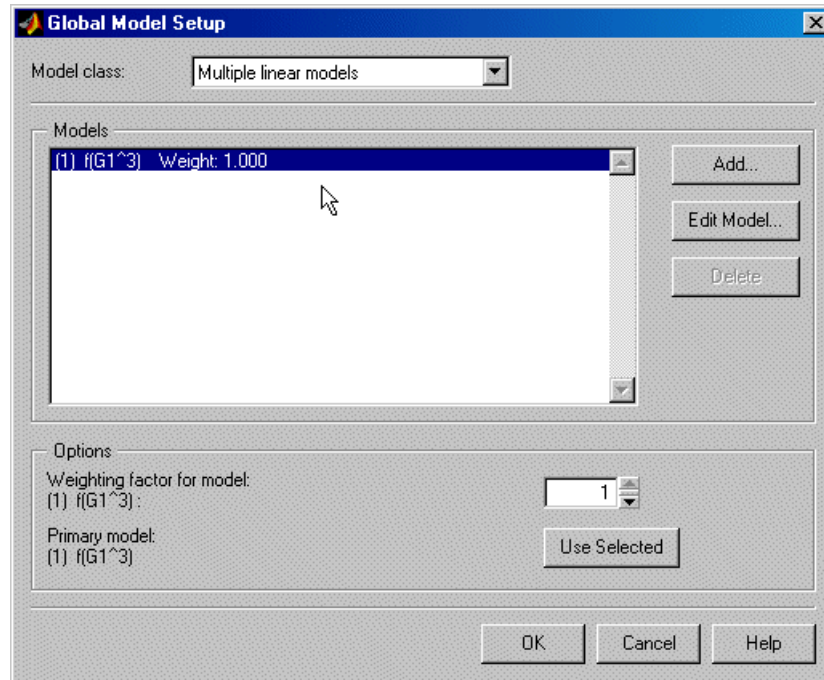

This is primarily for designing experiments using optimal designs. If you have no idea what model you are going to fit, you would choose a space-filling design. However, if you have some idea what to expect, but are not sure exactly which model to use, you can specify a number of possible models here. The Design Editor can average optimality across each model.

For example, if you expect a quadratic and cubic for two factors but are unsure about a third, you can enter several alternative polynomials here. You can change the weighting of each model as you want (for example, 0.5 each for two models you think equally likely). This weighting is then taken into account in the optimization process in the Design Editor.

The model that appears in the model tree is the one you select, listed as **Primary model**. Click the model in the list, then click **Use Selected**. The **Primary model** changes to the desired model. If you do not select a primary model, the default is the first in the list.

When the model has been fitted, you can view the primary model at the global node. To compare the fit of all the alternatives, click **Build Models** in the toolbar, select **Multiple Linear Models** in the dialog box, and click **OK**. One of each model is then built as a selection of child nodes.

See also “Polynomials” on page 5-67, and “Local Model Class: Multiple Models” on page 5-22.

Global Model Class: Free Knot Spline

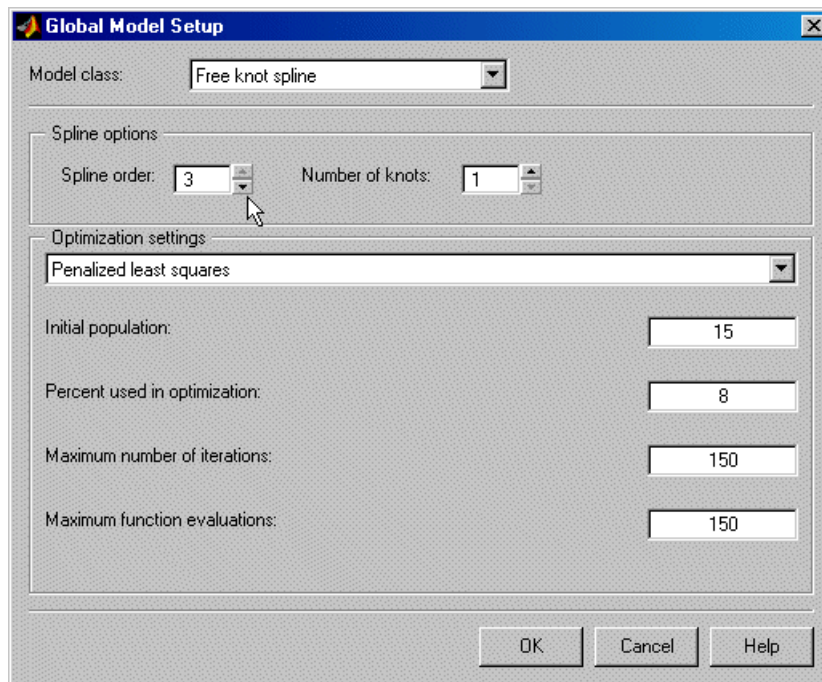

This option is only available for global (and local) models with only one input factor. See also “Hybrid Splines” on page 5-68 for a description of splines. The major difference is that you choose the position of the knots for hybrid splines; here the optimal knot positions are calculated as part of the fitting routine.

You can set the number of knots and the spline order can be between one and three.

There are three different algorithms under **Optimization settings**: Penalized least squares, Genetic algorithm, and Constrained least squares.

For all three methods, you can set the **Initial population**. This is the number of initial guesses at the knot positions. The other settings put limits on how long the optimization takes.

The following example shows a free knot spline model with three knots. The position of the knots is marked on the N axis.

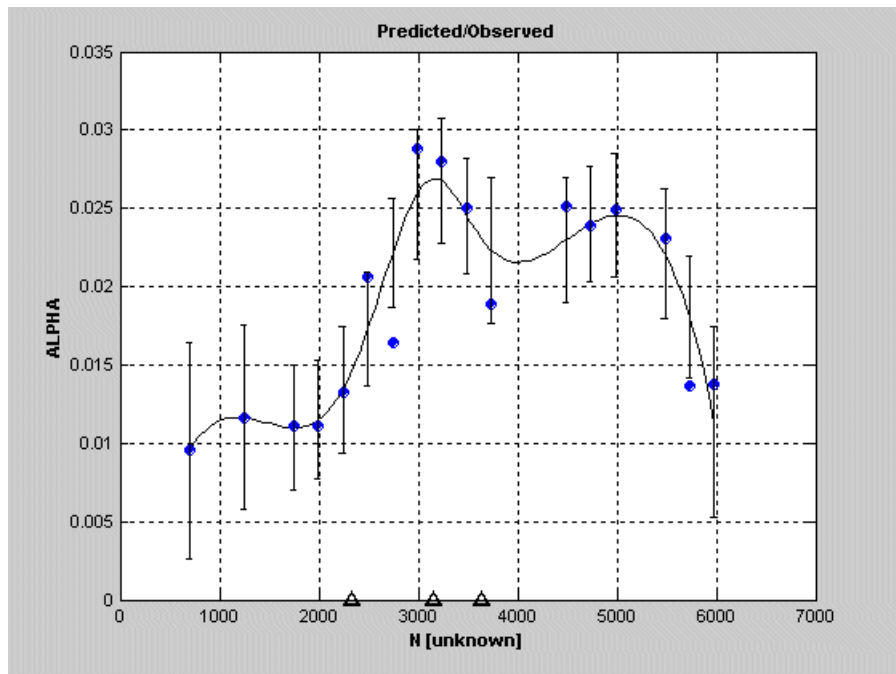

See also the local models involving splines:

- “Polynomial Spline” on page 5-6
- “Local Model Class: Truncated Power Series” on page 5-9
- “Local Model Class: Free Knot Spline” on page 5-11

Global Model Class: Neural Network

Neural network models require the Neural Network Toolbox product. If any of your global models are neural nets you cannot use MLE (maximum likelihood estimation) for your two-stage model.

Neural nets contain no preconceptions of what the model shape will be, so they are ideal for cases with low system knowledge. They are useful for functional prediction and system modeling where the physical processes are not understood or are highly complex.

The disadvantage of neural nets is that they require a lot of data to give good confidence in the results, so they are not suitable for small data sets. Also, with higher numbers of inputs, the number of connections and hence the complexity increase rapidly.

MBC provides an interface to some of the neural network capability of the Neural Network Toolbox product. Therefore these functions are only available if the Neural Network Toolbox product is installed.

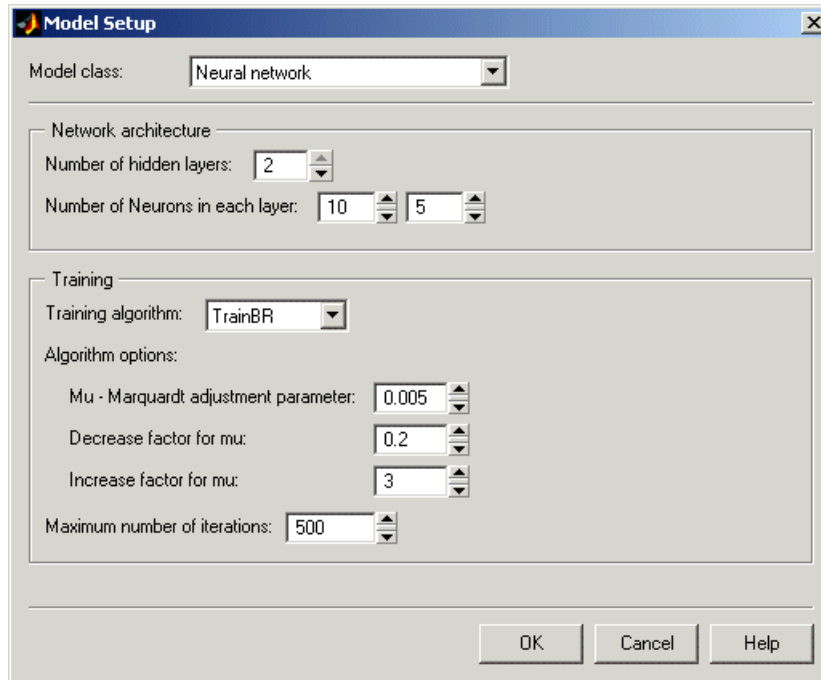

For help on the neural net models implemented in the Model-Based Calibration Toolbox product, see the Neural Network Toolbox documentation. At the MATLAB command line, enter

```
>>doc nnet
```

The training algorithms available in the Model-Based Calibration Toolbox product are `traingdm`, `trainlm`, `trainbr`.

These algorithms are a subset of the ones available in the Neural Network Toolbox product. (The names indicate the type: gradient with momentum, named after the two authors, and Bayesian reduction). Neural networks are inspired by biology, and attempt to emulate learning processes in the brain.

Neural nets contain no preconceptions of what the model shape will be, so they are ideal for cases with low system knowledge. They are useful for

functional prediction and system modeling where the physical processes are not understood or are highly complex.

The disadvantage of neural nets is that they require a lot of data to give good confidence in the results, so they are not suitable for small data sets. Also, with higher numbers of inputs, the number of connections and hence the complexity increase rapidly.

See the Neural Network Toolbox documentation for more help.

Global Model Class: User-Defined and Transient Models

These models can be local, global, or one-stage models. For set up information see “Local Model Class: User-Defined Models” on page 5-26 and “Local Model Class: Transient Models” on page 5-35.

New Response Models and Datum Models

In this section...

“Adding New Response Models” on page 5-87

“Datum Models” on page 5-88

Adding New Response Models

When you first set up a test plan, the Data Wizard automatically contains the response model setup after the data matching functions.

The following applies when you return to a previously setup test plan to add a new response model, or when you click the **New** button at test plan level to add new response models to an existing test plan.

Double-click the Responses outport of the block diagram or use the **New Response Model** item in the **File** menu, or use the toolbar icon. (None of these is available unless you are in the Test Plan view, that is, have the test plan node selected in the model tree. This should be obvious; you can only see the test plan block diagram with the test plan node selected.)

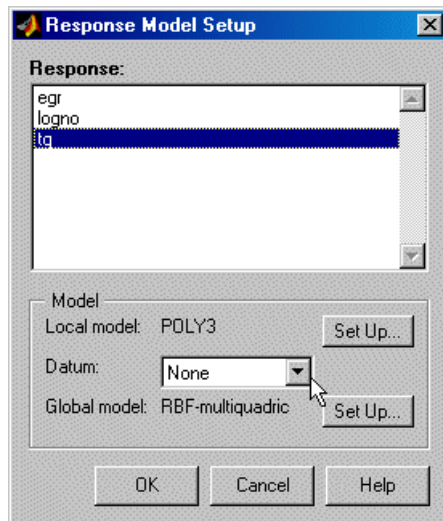

The Response Model Setup dialog box has a list box containing all the variables in the selected data set *except* the inputs to the local and global models; you cannot use an input also as a response.

You can reach the “Local Model Setup” on page 5-4 and “Global Model Setup” on page 5-66 dialog boxes using the **Set Up** buttons to change the local and global models also, and you can add “Datum Models” on page 5-88 (maximum or minimum) if the local model supports this. See below for more information.

You can return to the local or global setup options individually at any time by double-clicking the block in the test plan diagram.

Datum Models

Under **Datum** you can choose a datum model when setting up a new response model, but only for some local models — polysplines and polynomials (but see Linked Datum Models following). Other local models cannot have a datum model, as they do not necessarily have a unique turning point.

The datum model tracks the maximum or minimum of the local models. This is equivalent to adding the maximum or minimum as a response feature, which can be useful for analysis if those points are interesting from an engineering point of view.

The Datum options are

- None
- Maximum — This can be useful in cases using polyspline modeling of torque against spark. The maximum is often a point of engineering interest.
- Minimum — This can be useful for cases where the object is to minimize factors such as fuel consumption or emissions.
- Linked datum model — This is only available to subsequent two-stage models within a test plan in which the *first* two-stage model has a datum model defined. In this case you can make use of that datum model. The linked datum option carries the name of the response of the first two-stage model, where it originated.

If the maximum and minimum are at points of engineering interest, like MBT or minimum fuel consumption, you can add other response features later using the datum model (for example, MBT plus or minus 10 degrees of spark angle) and track these across local models too. It can be useful to know the value of MBT when modeling exhaust temperature, so you can use a linked datum model from a previous torque/spark model. Having responses relative to datum can also be a good thing as it means the response features are more likely to relate to a feature within the range of the data points.

You can also export the datum model along with local, global, and response models if required. See “Export Models to MATLAB, Simulink, and CAGE” on page 6-117.

Fitting Process for Polynomial Splines With a Datum Model

The fitting process for a polynomial spline with a maximum datum is:

- 1** The toolbox fits a quadratic polynomial to the data.
- 2** The toolbox finds the x-location of the maximum of this polynomial (if it doesn't have a maximum, then the model will not be fitted).
- 3** The toolbox uses this x-value as a starting point in an optimization to find the best knot position for the polynomial spline. Note this optimization does not have any constraint that B_{high2} stays negative.
- 4** The toolbox checks the result to see if the new knot position is still at the maximum of the curve. If so, then finish.

If this is not the case, then the algorithm returns to the quadratic polynomial fitted in step 1, which has the required maximum.

Build Alternative Models to Compare

In this section...

“Build a Selection of Models” on page 5-90

“New Template” on page 5-91

“User-Defined Template” on page 5-91

“Polynomial Template” on page 5-92

“RBF Template” on page 5-92

“Hybrid RBF Template” on page 5-93

“Free Knot Spline Template” on page 5-93

“Model Browser Template” on page 5-94

Build a Selection of Models

The option **Build Models** () is in the toolbar and the **Model** menu for global models, and in the **Model** menu for local models. You can use this to quickly build a selection of models as child nodes of the current global model node, or in the case of local models, to build a selection of child nodes for each response feature node. You can use predefined templates, model types in the current project, create templates within the Build Models dialog box, or create templates from a model with existing child nodes by selecting **Model > Make Template**.

See also “Parallel Model Building” on page 5-95.

Once you have used the Build Models dialog box to create a number of child nodes, the best model of this selection will be automatically selected (it will have a blue icon), based on the selection criteria you choose (such as PRESS RMSE, RMSE, Box-Cox, or Parameters). For local nodes, the best child node of each response feature is chosen.

See the Quick Start tutorial section “Create Multiple Models to Compare” in the Getting Started documentation for a step by step example of using the Build Models dialog box to quickly create many models to search for the best fit.

Note Once you start building models from any template, you can always click **Stop** to abort model building if the process is taking too long.

New Template

To create a template containing the models you want to build,

- 1 Click **New** then click **OK**.
- 2 Click **Add** in the following Multi-Model Settings dialog box to reach the Model Setup dialog box, where you can select any model type available for the number of inputs. Click **OK** to add the model and return to the Multi-Model Settings dialog box.
- 3 Click **Add** again to repeat the process to add as many different models as you like. You can click **Edit Model** to change the settings for any models in the list.
- 4 When you are satisfied, click **OK** in the Multi-Model Settings dialog box, and your chosen selection of model types are built as a selection of child nodes of the currently selected model node.
- 5 The Model Selection dialog box appears, where you can select the criterion for automatically choosing the best child node. Use the drop-down menu to select from the available criteria (such as from PRESS RMSE, RMSE, Box-Cox, Observations or Parameters). You can select additional criteria to appear here using the Summary Statistics options, from the **Model** menu. See “Model Menu (Global Level)” on page 6-37 and “Summary Statistics” on page 6-69. Click **OK** to accept the chosen criterion.

User-Defined Template

You can save templates of models you have already built by using the **Model > Make Template** menu item from any global modeling node with child nodes. User-defined templates can then be found via the Build Models dialog box. You can use the Browse button to find stored templates that are not in the default folder. Select your template and click **OK**. The models are built and the Model Selection dialog box appears, where you can select the criterion for automatically choosing the best child node.

Polynomial Template

You can use the polynomial template to build a variety of polynomials of different orders.

- 1** Select **Polynomials** and click **OK**. The Model Building Options dialog box opens where you can specify the model settings.
- 2** Choose the minimum and maximum order of the polynomials you want to build, and whether to use Stepwise settings. For example, if you choose 1 and 5 as the minimum and maximum polynomial order, 5 child node models are built (linear, quadratic, cubic, and so on). If you choose a Stepwise setting (e.g. Minimize PRESS) it is applied to all child models.
- 3** Click **Build** and the models are built. The Model Selection dialog box appears, where you can select the criterion for automatically choosing the best child node.

RBF Template

You can use the RBF template to build a variety of radial basis function models with varying maximum numbers of centers and/or different kernels.

- 1** Select **RBF** and click **OK**. The Model Building Options dialog box opens where you can specify the model settings.
- 2** Enter a vector in the edit box to specify the maximum numbers of centers for each child model. This can be a MATLAB expression including the number of observations, e.g. 10:10:nObs/2.
- 3** If the current model node is an RBF, the same model settings are used by default. Click **Model Settings** to open the Radial Basis Function Model Settings dialog box, where you can view and change all the model parameters such as kernel and widths. See “Types of Radial Basis Functions” on page 7-3.
- 4** Select the check box **Build all kernels** to create child models with the specified range of centers for each kernel type.
- 5** Click **Build** and the models are built. The Model Selection dialog box appears, where you can select the criterion for automatically choosing the best child node.

Hybrid RBF Template

You can use the Hybrid RBF template to build a variety of hybrid radial basis function models with varying maximum numbers of centers and/or different kernels.

- 1** Select **Hybrid RBF** and click **OK**. The Model Building Options dialog box opens where you can specify the model settings.
- 2** Enter a vector in the edit box to specify the maximum numbers of centers for each child model. This can be a MATLAB expression including the number of observations, e.g. `10:10:nObs/2`.
- 3** If the current model node is a hybrid RBF, the same model settings are used by default. Click **Model Settings** to open the Hybrid RBF Model Settings dialog box, where you can view and change all the model parameters such as kernel and widths (and the order of the polynomial part of the model on the **Linear Part** tab). See “Hybrid Radial Basis Functions” on page 7-31.
- 4** Select the check box **Build all kernels** to create child models with the specified range of centers for each kernel type.
- 5** Click **Build** and the models are built. The Model Selection dialog box appears, where you can select the criterion for automatically choosing the best child node.

Free Knot Spline Template

You can use the Free Knot Spline template to build a variety of free knot spline models of different numbers of knots. Only available for models with a single input factor.

- 1** Select **Free Knot Spline** and click **OK**. The Model Building Options dialog box opens where you can specify the model settings. If the current model node is a free knot spline, the same model settings are used by default.
- 2** Choose the initial and final number of knots. For example if you specify the initial and final numbers of knots as 1 and 5, five child nodes are built, one with one knot, one with two and so on.

- 3 Click **Build** and the models are built. The Model Selection dialog box appears, where you can select the criterion for automatically choosing the best child node.

Model Browser Template

You can use the Model Browser template to build a copy of an existing set of child model types in the current project. This avoids the need to create a model template first.

- 1 Select **Model Browser** and click **OK**.
- 2 The Model Tree dialog box opens. Select a model from the model tree which has the child node model types you want to build. You can also use this template to select a local multiple model node to copy. Click **OK** to return to the Build Models dialog box.
- 3 Click **Build** and the models are built. The Model Selection dialog box appears, where you can select the criterion for automatically choosing the best child node.

Parallel Model Building

If you have Parallel Computing Toolbox available, you can distribute model building tasks to a cluster of computers. The toolbox automatically builds models in parallel if you have `matlabpool` open.

Parallel builds can significantly reduce computation time for building large numbers of models, as long as each model fit takes a lot longer than the time taken to send the task to another processor.

Note In R2011a, you no longer need to use the function `mbcmatlabpool` to configure the toolbox to fit models using the parallel language worker pool. `mbcmatlabpool` will be removed in a future release.

Use `matlabpool` alone. Model building tasks run in parallel if you have `matlabpool` open.

- 1 Start the parallel language worker pool by entering `matlabpool` at the command line.

These model fitting tasks run in parallel:

- Build models from model templates (see “Build Alternative Models to Compare” on page 5-90).
- Build alternative models for local multiple models.
- Update response or response feature models after changing data.

Note No progress bars display when fitting multiple models in parallel.

- 2 Turn off parallel execution by entering `matlabpool close`. Progress bars display as modeling tasks build.

See the functions `matlabpool` and `parfor`.

Note Opening `matlabpool` can prevent other jobs (e.g., distributed optimizations in CAGE) from processing.

Selecting Models

This section discusses the following topics:

- “Examine Local Models” on page 6-2
- “Examine Global Models” on page 6-26
- “Compare and Select Best Models” on page 6-42
- “Model Selection Guide” on page 6-64
- “Calculate and Compare MLE” on page 6-75
- “Examine Two-Stage Response Model” on page 6-79
- “Evaluate Model Fit” on page 6-82
- “Stepwise Regression” on page 6-87
- “Box-Cox Transformation” on page 6-100
- “Two-Stage Models for Engines” on page 6-104
- “Export Models to MATLAB, Simulink, and CAGE” on page 6-117
- “Export Models to Simulink” on page 6-118
- “Export Models to the Workspace” on page 6-123

Examine Local Models

In this section...

“What Is Local Level?” on page 6-2

“Using Local Model Plots” on page 6-5

“Viewing Local Model Statistics” on page 6-8

“Using the RMSE Explorer with Local Models” on page 6-12

“Removing Outliers and Updating Fits” on page 6-13

“Local Level Tools” on page 6-18

“Calculating Two-Stage Models and Response Features” on page 6-24

What Is Local Level?

When you select a local node (with the  icon) in the model tree, the local level view appears. At the local level you can:

- View local model plots and statistics, and scroll through all local models test by test. See “Using Local Model Plots” on page 6-5, and “Viewing Local Model Statistics” on page 6-8.
- Look for problem tests with the RMSE Explorer. See “Using the RMSE Explorer with Local Models” on page 6-12.
- Remove and restore outliers and update fits. See “Removing Outliers and Updating Fits” on page 6-13.
- Calculate two-stage models, and add or remove response features. After calculating the two-stage model, you can compare the local fit and the two-stage fit on the local level plots. See “Calculating Two-Stage Models and Response Features” on page 6-24.

Note that after the two-stage model is calculated the local node icon changes to a two-stage icon () to reflect this. See the model tree for clarification. The response node also has a two-stage icon, but produces the response level view instead.

The following example shows a local model of torque/spark curves. In this example the two-stage model has been calculated so you can compare the local fit and the two-stage fit on the plots.

6 Selecting Models

Click here to change test

Test: Select Test... Model type: $f(S^2, S^3)$

Model Data

Residuals

SPK (S) [deg]

X-axis factor: SPK (S) [deg] Y-axis factor: Residuals

Local response

BTQ [Nm]

SPK (S) [deg]

- Data
- Local fit
- Datum
- Two-stage at data
- Two-stage fit
- Two-stage datum

Response Features	Observations	Parameters	Box-Cox	PRESS RMSE
knot	186	44	0	2.8341
max	188	20	1	1.2829
Bhigh_2	188	42	1	0.0032213
Blow_2	188	45	1	0.0065521

New Delete Select...

Univariate Model with knot, max, Bhigh_2, Blow_2 is the best two-st

Diagnostic statistics

Local parameters

knot

max

Bhigh_2

Blow_2

Pooled statistics

Local RMSE

Two-Stage RMSE

PRESS RMSE

Two-Stage T^2

-log L

Test notes

Test number color:

Click-and-drag anywhere along this line to change the size of the Response Features pane

Click-and-drag or double-click here to expand plots/hide statistics pane

The default view is the **Model** tab, with plots described below. You can click the **Data** tab to view plots of other variables. See “Data Tab” on page 6-7.

Using Local Model Plots

- “Local Special Plots” on page 6-5
- “Local Scatter Plots” on page 6-7
- “Data Tab” on page 6-7
- “Test Notes Pane” on page 6-8

Local Special Plots

You can scroll through all the local models by using the up and down test buttons, type directly in the edit box or go directly to test numbers by clicking **Select Test**.

The lower plots are referred to as *special plots* as they can be different for different models.

The lower plot at the local level shows the local model fit to the data *for the current test only*, with the datum point if there is a datum model. If there are multiple inputs to the local model, a predicted/observed plot is displayed. In this case to examine the model surface in more detail you can use **Model > Evaluate**. See “Evaluate Model Fit” on page 6-82.

To examine the local fit in more detail, double-click the arrows (indicated in the preceding figure) to hide the scatter plot and expand the lower plot. You can zoom in on parts of the plot by **Shift**-click-dragging or middle-click-dragging on the place of interest on the plot. Return to full size by double-clicking.

You can select the plot type from the drop-down menu at the top of the plot. Choices here can be:

- Local Response

- **Normal Plot** Normal plots are a useful graph for assessing whether data comes from a normal distribution. For more information, see “Normal Probability Plots” in the Statistics Toolbox documentation.
- **Validation Residuals** If you are using validation data, the plot shows the local model validation residuals if there is validation data for the current test (the global variables must match). If there is a two-stage model, the two-stage validation residuals are also shown. Validation data must be attached at the “Use Test Plans to Set Up Designs, Data, and Models” on page 2-15. See “Using Validation Data” on page 6-84.
- **Surface and Contour** are only available for models with two inputs. You can view a surface or contour plot with data points.

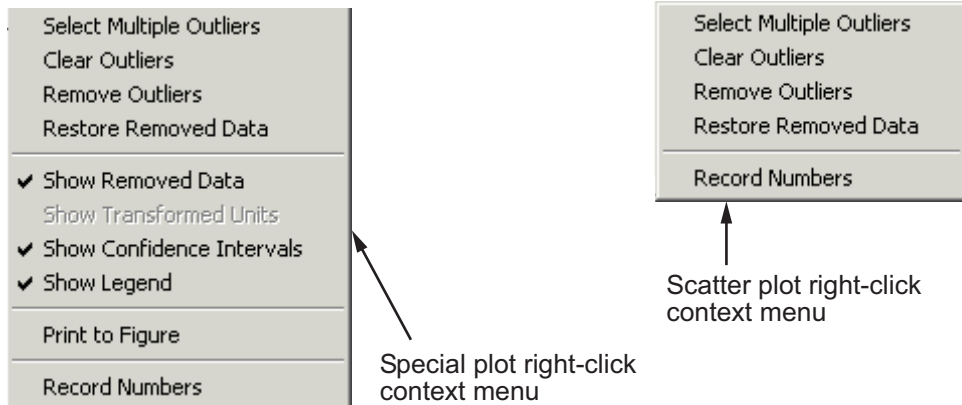

Above are the right-click context menus for both plots. On both plots you can manipulate outliers with all the same commands available in the **Outliers** menu. See “Outliers Menu (Local Level)” on page 6-13 for details.

The **Print to Figure** command opens a MATLAB figure plot showing the current plot. On the special plots you can switch the confidence intervals and legend on and off, and hide or show removed data. For both plots you can switch the display of **Record Numbers** on and off. This is similar to test number for global models but relates to individual records within tests.

Local Scatter Plots

The upper plots are referred to as *scatter plots*. They can show various scatter plots of statistics for assessing goodness-of-fit for the current local model shown. Upper scatter plots are replaced by an icon if you resize the Browser too small.

The statistics available for plotting are model dependent.

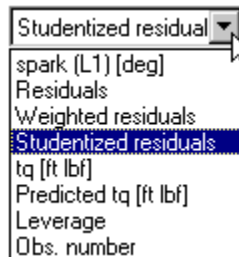

The preceding is an example drop-down menu on the scatter plot for changing x and y factors. In this case `spark` is the local input factor and `torque` is the response. The local inputs, the response, and the predicted response are always available in these menus. The observation number is also always available.

The other options are statistics that are model dependent, and can include residuals, weighted residuals, studentized residuals, and leverage. At local level these are internally studentized residuals.

Data Tab

When you click the **Data** tab at the local level, or select **View > Data Plots**, you can view plots of the data for the current test.

- Use the right-click menu item **Set Up Plot Variables** to open the Plot Variables Setup dialog box.
- The dialog box appears automatically if you open the tab using the **View** menu.

In the Plot Variables Setup dialog box, you can choose to view any of the data signals in the data set for the current test (including signals not being used in modeling).

- Choose variables from the list on the left and use the buttons to move them into the **Y Variable(s)** list or the **X variable** edit box.
- You can use the **No X Data** button to plot a variable against record number only.

Note Remember you can also display values of global variables in the Diagnostic Statistics pane if you want to see these values at the same time as the **Model** tab.

Test Notes Pane

You can use the **Test Notes** pane to record information on particular tests. Each test has its own notes pane. Data points with notes recorded against them are colored in the global model plots. You choose the color using the **Set Color** button in the **Test Notes** pane.

Viewing Local Model Statistics

- “Diagnostic Statistics Pane” on page 6-8
- “Pooled Statistics” on page 6-10

Diagnostic Statistics Pane

The **Diagnostic Statistics** pane drop-down menu is shown, where you can select the information to be displayed in the pane.

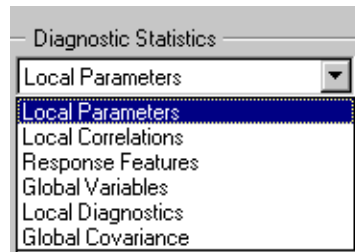

If there is not enough room there are scroll bars.

- Local Parameters — Shows the values and standard errors of the parameters in the local model for the current test selected.
- Local Correlations — Shows a table of the correlations between the parameters.
- Response Features — Shows the values and standard errors of the response features defined for this local model, from the current test (often some or all of them are the same as the parameters; others are derived from the parameters).
- Global Variables — Shows the values and standard errors of the global variables at the position of the current test.
- Local Diagnostics — s_i (the standard error for the current (i^{th}) test), number of observations, degrees of freedom on the error, R squared, $\text{Cond}(\mathbf{J})$ and $\text{Cond}(\mathbf{\Sigma})$: the condition indices for the Jacobian matrix and the covariance matrix.

Note Check for high values of **Cond(J)** (e.g., $> 10^8$). High values of this condition indicator can be a sign of numerical instability.

Validation RMSE for the current test appears here if there is validation data for the current test.

- Global Covariance — For MLE models, shows a covariance matrix for the response features at the global level.

Pooled Statistics

These are seen at the local node (when two-stage modeling) in the Pooled Statistics table, and at the response node in the list of local models. If you have a selection of local or two-stage models, use these statistics to help you choose which model is best.

Local RMSE	Root mean squared error between the local model and the data for all tests. The divisor used for RMSE is the number of observations minus the number of parameters.
Two-Stage RMSE	Root mean squared error between the two-stage model and the data for all tests. You want this error to be small for a good model fit.
PRESS RMSE	Root mean squared error of predicted errors, useful for indicating overfitting; see “PRESS statistic” on page 6-97. The divisor used for PRESS RMSE is the number of observations. Not displayed for MLE models because the simple univariate formula cannot be used.
Two-Stage T ²	<p>T² is a normalized sum of squared errors for all the response features models. You can see the basic formula on the Likelihood view of the Model Selection window.</p> $T^2 = (y_{rf} - \hat{y})^T \Sigma^{-1} (y_{rf} - \hat{y})$ <p>Where $\Sigma = \text{blockdiag}(C_i + D)$, where C_i is the local covariance for test i. See <i>blockdiag</i> diagram following.</p> <p>A large T² value indicates that there is a problem with the response feature models.</p>

-log L	<p>Log-likelihood function: the probability of a set of observations given the value of some parameters. You want the likelihood to be large, tending towards -infinity, so large negative is good.</p> <p>For n observations x_1, x_2, \dots, x_n, with probability distribution $f(x, \theta)$, the likelihood is:</p> $L = \prod_{i=1}^n f(x_i, \theta)$ <p>This is the basis of “Calculate and Compare MLE” on page 6-75.</p> $\log L = \log(\det(\Sigma)) + (y_{rf} - \hat{y})^T \Sigma^{-1} (y_{rf} - \hat{y})$ <p>which is the same as:</p> $\log L = \log(\det(\Sigma)) + T^2$ <p>This assumes a normal distribution.</p> <p>You can view plots of -log L in the Model Selection window, see “Likelihood View” on page 6-55.</p>
Validation RMSE	<p>Root mean squared error between the two-stage model and the validation data for all tests.</p>

To explain blockdiag as it appears under T^2 in the Pooled statistics table: $\Sigma = \text{blockdiag}(C_i + D)$, where C_i is the local covariance for test i , is calculated as shown below.

$$\text{blockdiag}(C_i + D) = \begin{bmatrix} C_1 + D & & & \\ & C_2 + D & & \\ & & C_3 + D & \\ & & & C_i + D \end{bmatrix}$$

Using the RMSE Explorer with Local Models

You can open the RMSE Explorer to view plots of the standard errors of all the tests, both overall and by response feature. This tool can help you quickly identify problem tests. You can navigate to a test of interest from the RMSE Explorer by double-clicking a point in the plot to select the test in the Model Browser local model view.

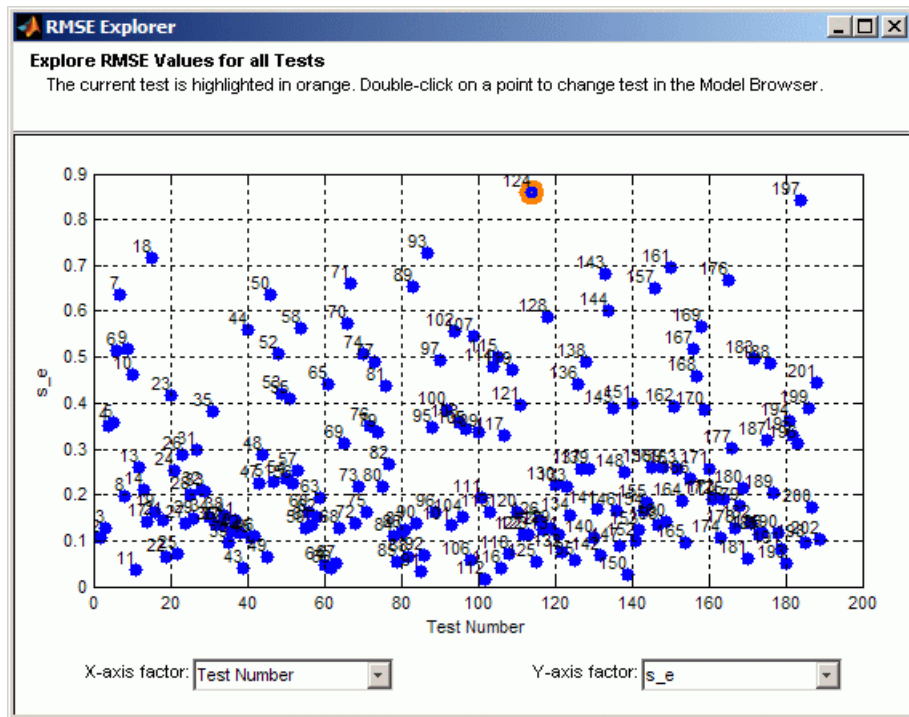

The plot displays one value of standard error per test, overall and for each response feature. As a best practice, first plot plain s_e against test number to get an idea of how the error is distributed and locate any tests with much higher errors. Right-click to toggle display of test numbers. Ideally, all the standard errors should be roughly the same value to satisfy the statistical assumptions for two-stage models. If these assumptions are not satisfied, error estimates for two-stage models may not be valid.

You can also use the X- and Y-axis factor drop-down lists to plot these standard errors against the global variables to examine the global distribution of error.

Removing Outliers and Updating Fits

- “Removing and Restoring Outliers” on page 6-13
- “Updating Fits” on page 6-14
- “Outlier Selection Criteria” on page 6-15

Removing and Restoring Outliers

You can use the right-click context menus on all plots or the **Outliers** menu to remove and restore outliers.

Outliers Menu (Local Level).

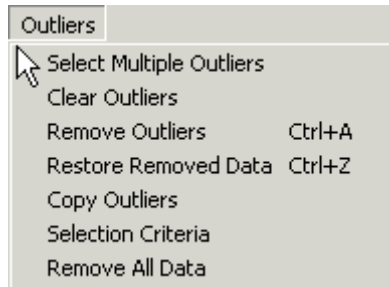

All the commands except **Remove All Data** and **Copy Outliers** are also available in the right-click context menus on all plots.

- **Select Multiple Outliers** — Use this item to draw a selection box around as many data points as required to select them all as outliers. This is useful for removing many data points at once.
- **Clear Outliers** — Returns all data points to the unselected state (that is, no points outlined in red) as possible outliers.
- **Remove Outliers** — Removes red-outlined data points from the fit and refits the current local fit only. Use the Update Fit toolbar button or **Model > Update Fit** to refit all the global models also. You can choose

to update or defer when another node is selected. See “Updating Fits” on page 6-14.

- **Restore Removed Data** — Opens the Restore Removed Data dialog box, where you can choose the points to restore from the list by record number, or restore all available points. You can also press **Ctrl+Z**. Select points in the left list and use the buttons to move points between the lists. When you click **OK** this refits the local model, including all data points previously removed as outliers. Use **Update Fit** once more to refit the global models, or you are prompted when a new node is selected. See “Updating Fits” on page 6-14.
- **Copy Outliers** — Opens the Copy Outliers dialog box, where you can choose which model’s outliers to copy. Select a model (of the same type — local or global) in the tree and click **OK**, and the current model (and other models affected) are refitted using the outlier selections for that model.
- **Selection Criteria** — Opens the Outlier Selection Criteria dialog box where you can set the criteria for the automatic selection of outliers. This is disabled for MLE models.
- **Remove All Data** — Leaves the current local model with no data, so entirely removes the current test. This test is removed from all the global models.

Updating Fits

When you remove an outlier from your local model, it refits immediately. Other dependent fits also need updates. You can choose when to update the other fits. Removing an outlier can affect several other models. Removing an outlier from a best local model changes all the response features for that two-stage model. The global models all change; therefore the two-stage model must be recalculated. For this reason the local model node returns to the local (house) icon and the response node becomes blank again. If the two-stage model has a datum model defined, and other models within the test plan are using a datum link model, they are similarly affected.

To update fits, either:

- In the local view, use the Update Fit toolbar button to update all the dependent fits.

- When you select another model node, you are prompted to update or defer updates.

When leaving the local node, a dialog box asks if you want to update all dependent fits. Click **Yes** to update all global models, or **No** to delay lengthy updates of dependent fits. Delaying updates can be useful when you want to examine only a particular global model after removing an outlier at the local level. With the defer option, you can avoid waiting while updating all other dependent fits.

If you defer updating fits and you go to a response feature node, the toolbox refits only that node, so you can inspect that global model fit. Other response features do not update unless you click them. When you return to the local node again the Update Fit button is enabled. Until you update fits, a status message at the bottom of the browser tells you that you have deferred updates.

Outlier Selection Criteria

You can select outliers as those satisfying a condition on the value of some statistic (for example, residual > 3), or by selecting those points that fall in a region of the distribution of values of that statistic.

For example, assume that residuals are normally distributed and select those with p-value > 0.9. You can also select outliers using the values of model input factors.

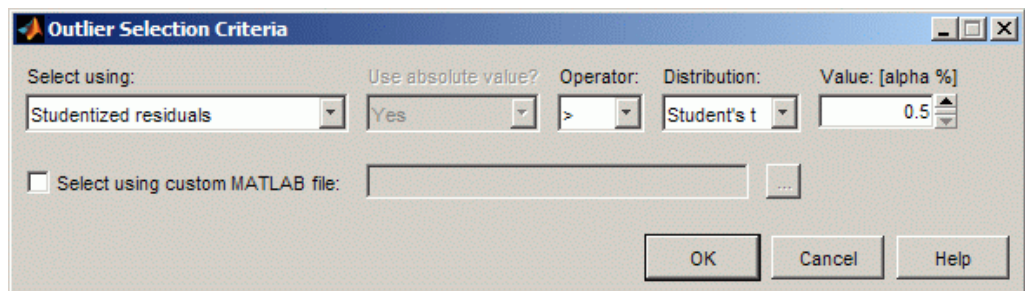

The drop-down menu labeled **Select using** contains all the available criteria, shown in the following example.

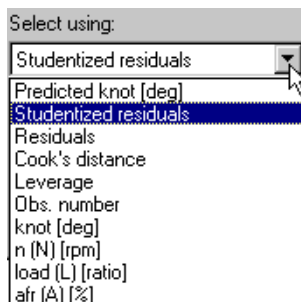

The options available in this menu change depending on the type of model currently selected. The options are exactly the same as those found in the drop-down menus for the x - and y -axis factors of the scatter plots in the Model Browser (local level and global level views).

In the preceding example, the model selected is the knot response feature, so knot and Predicted knot appear in the criteria list, plus the global input factors; and it is a linear non-MLE model, so Cook's Distance and Leverage are also available.

The range of the selected criteria (for the current data) is indicated above the **Value** edit box, to give an indication of suitable values. You can type directly in the edit box. You can also use the up/down buttons on this box to change the value (incrementing by about 10% of the range).

Distribution. You can use the **Distribution** drop-down menu to remove a proportion of the tail ends of the normal or t distribution. For example, to select residuals found in the tails of the distribution making up 10% of the total area:

- Select Normal in the **Distribution** drop-down menu.
- Select the operator >.
- Enter 10 as the α % value in the edit box.

Residuals found in the tails of the distribution that make up 10% of the total area are selected. If you had a vast data set, approximately 10% of the residuals would be selected as outliers.

As shown, residuals found beyond the value of Z_{α} in the distribution are selected as outliers. α is a measure of significance; that is, the probability of finding residuals beyond Z_{α} is less than 10%. Absolute value is used (the modulus) so outliers are selected in both tails of the distribution.

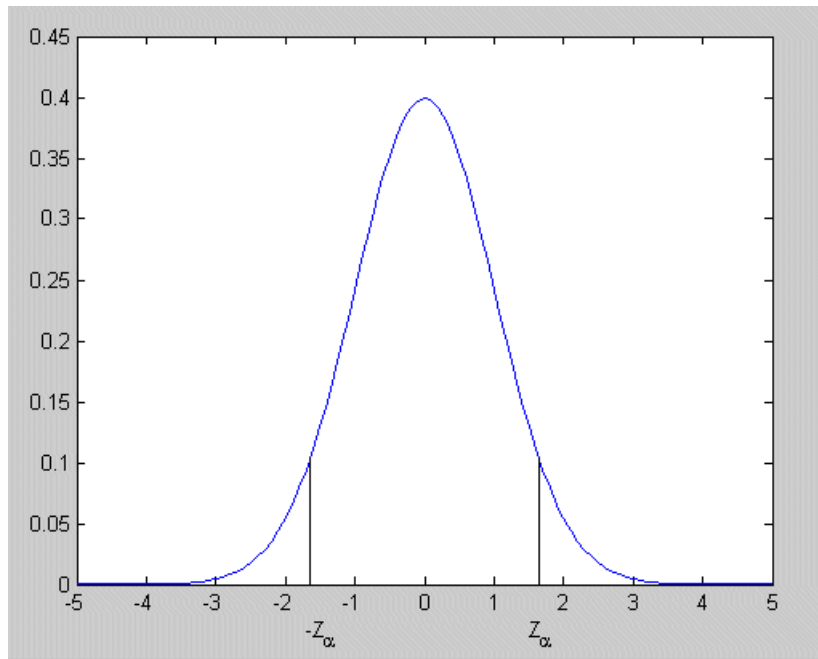

The t distribution is used for limited degrees of freedom.

If you select **None** in the **Distribution** drop-down menu, you can choose whether or not to use the absolute value. That is, you are selecting outliers using the actual values rather than a distribution. Using **absolute value** allows you to select using magnitude only without taking sign into account (for example, both plus and minus ranges). You can select **No** here if you are only interested in one direction: positive *or* negative values, above *or* below the value entered. For example, selecting only values of speed below 2000 rpm.

The **Select using custom MATLAB file** check box enables the adjacent edit box. Here you can choose a function file that selects outliers. Type the name of the file and path into the edit box, or use the browse button.

In this file you define a MATLAB function of the form:

```
function outIndices = funcname (Model, Data, Names)
```

`Model` is the current MBC model.

`Data` is the data used in the scatter plots. For example, if there are currently 10 items in the drop-down menus on the scatter plot and 70 data points, the data make up a 70 x 10 array.

`Names` is a cell array containing the strings from the drop-down menus on the scatter plot. These label the columns in the data (for example, spark, residuals, leverage, and so on).

The output, `outIndices`, must be an array of logical indices, the same size as one column in the input `Data`, so that it contains one index for each data point. Those points where `index = 1` in `outIndices` are highlighted as outliers; the remainder are not highlighted.

Local Level Tools

- “Local Level: Toolbar” on page 6-19
- “Local Level: Menus” on page 6-20

Local Level: Toolbar

This toolbar appears when a local node is selected in the model tree.

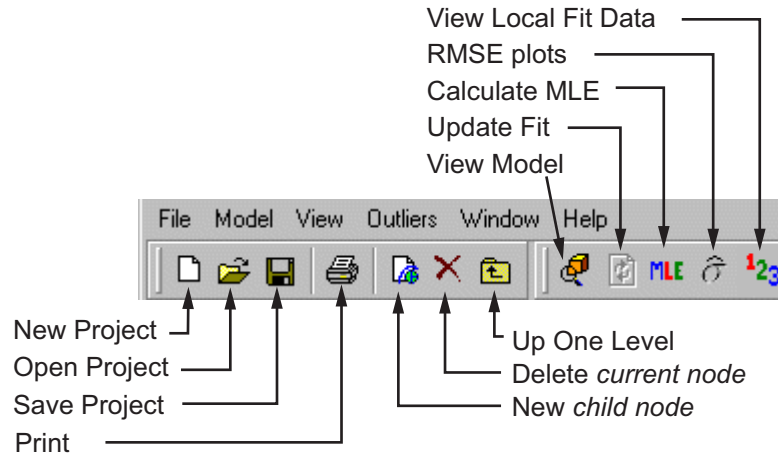

The eight left icons remain constant throughout the levels. They are for project and node management, and the help button, and here the print icon is enabled as there are plots in this view. See “Use Project Tools” on page 2-7 for details on these buttons. In the example shown the slider bar has been dragged to hide the Help button.

- View Model — Opens a dialog box displaying the terms in the current model. See “Model Definition Dialog Box” on page 6-39.
- Update Fit — This button is only enabled when data has been excluded from the plot using the **Remove Outliers** command (in the right-click context menu or the **Outliers** menu). At this point the local fit in the view is updated to fit only the remaining data, but this change also affects a point in all the global models. You can make this update to all the global models by using this toolbar button, or you are prompted when another node is selected.

See “Updating Fits” on page 6-14.

- Calculate MLE — Calculates the two-stage model using maximum likelihood estimation. This takes correlations between response features into account. See “Calculate and Compare MLE” on page 6-75 for details.

- **RMSE Plots** — Opens the RMSE Explorer dialog box, where you can view plots of the standard errors of all the tests. See “Using the RMSE Explorer with Local Models” on page 6-12.
- **View Local Fit Data** — Opens the Data Editor, where you can view a read-only version of the inputs, predicted and actual responses. This allows you to examine and export your modeling data, using all the powerful display features of the Data Editor. Also in the **View** menu.

Local Level: Menus

File Menu. Only the **New** (child node) and **Delete** (current node) functions change according to the node level currently selected. Otherwise the **File** menu remains constant.

See “File Menu” on page 2-8.

Window and Help Menus. The **Window** and **Help** menus remain throughout the Model Browser, offering access to different windows, general help and context help.

See “Window Menu” on page 2-10 and “Help Menu” on page 2-10.

Model Menu (Local Level).

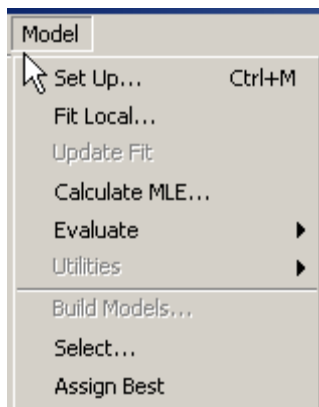

- **Set Up** — Opens the Local Model Setup dialog box where you can change the model type. See “Local Model Setup” on page 5-4.
- **Fit Local** — Opens the Local Model Fit Tool dialog box. Without covariance modeling, you see the following controls. This example shows the results after clicking **Fit** once. The optimization process can be stopped early by clicking **Stop** or you can wait until it finishes. The Ordinary Least Squares (OLS) parameters are displayed. You can click **Fit** to run the process again as many times as required, or **Close** to exit the dialog box. You can enter a different change in parameters in the edit box.

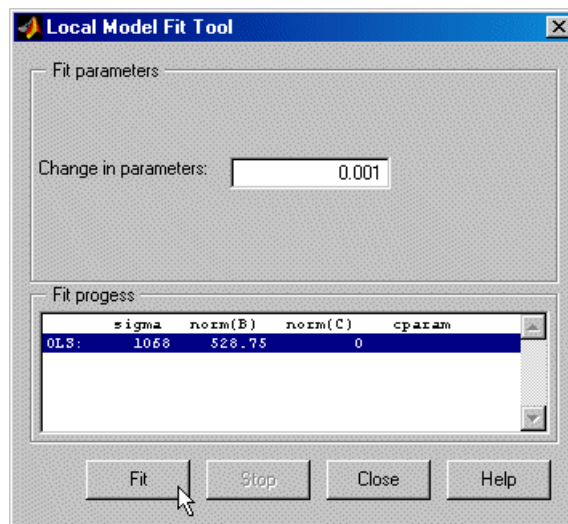

- For covariance models this offers three different algorithms: REML (Restricted Maximum Likelihood - the default), Pseudo-likelihood, and Absolute residuals. The following example shows that there is also an additional button, **One Step**. Using the **Fit** button might take several steps to converge, but if you use the **One Step** button only one step in the optimization process is taken.

Every time you run a process, the initial and final Generalized Least Squares parameter values are displayed for each iteration.

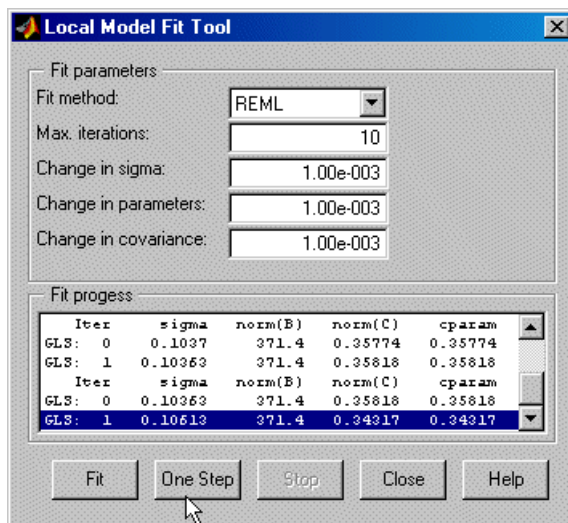

- **Update Fit** — Only enabled when outliers have been removed. The **Update Fit** option updates the global models to take these changes into account. You can also choose to update or defer updates when you select a different node. Duplicated in the toolbar. **Update Fit** can affect many models; see the explanation in “Updating Fits” on page 6-14.
- **Calculate MLE** — Calculates the two-stage model using maximum likelihood estimation. This calculation takes interactions between response features into account. Duplicated in the toolbar. See “Calculate and Compare MLE” on page 6-75 for details.
- **Evaluate** — Select from the submenu **Fit Data** (also **Ctrl+E**), **Validation Data**, **No Data**, or **Other Data**. Opens the Model Evaluation window displaying the fit relative to the selected data (or no data). You must attach validation data to the test plan before you can use it. If you select **Other Data** a wizard appears to select the data. See “Using Validation Data” on page 6-84.
- **Utilities** — Only enabled for local multiple models. See “Analyzing Point-by-Point Models” on page 1-10.

- **Build Models** — Opens the Build Models dialog box, where you can choose a selection of model types to build for each response feature. See “**Build Alternative Models to Compare**” on page 5-90.
- **Select** — Available whenever the **Select** button is also enabled in the lower right pane (when it is titled **Local Models, Response Features, or Models**). This item opens the Model Selection window to allow you to choose the best model. See “Comparing Models” on page 6-42.
- **Assign Best** — Selects the current model as best. If it is one of several child node models of a response model, selecting it as best means that this local model (and associated response features) is used for the two-stage model. Note that this option is only enabled if the local node selected has a two-stage model calculated; that is, if the local node still has a local icon (a house) you cannot use **Assign Best**. See “Calculating Two-Stage Models and Response Features” on page 6-24.

See also

- “Outliers Menu (Local Level)” on page 6-13 — see “Removing Outliers and Updating Fits” on page 6-13.
- “Outlier Selection Criteria” on page 6-15

View Menu (Local Level).

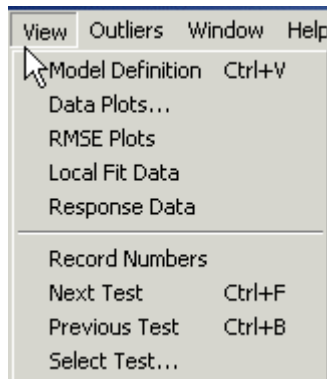

- **Model Definition** — Opens the Model Definition dialog box, showing the terms in the model. See “Model Definition Dialog Box” on page 6-39.

- **Data Plots** — Opens the **Data** tab on the display and the Plot Variables Setup dialog box, where you can choose to view any of the data signals in the data set for the current test (including signals not being used in modeling). Choose variables from the list on the left and use the buttons to move them into the **Y Variable(s)** list or the **X variable** edit box. You can use the **No X Data** button to plot a variable against record number only.
- **RMSE Plots** — Opens the RMSE Explorer where you can view plots of the standard errors of all the tests. See “Using the RMSE Explorer with Local Models” on page 6-12.
- **Local Fit Data** — Opens the Data Editor, where you can view a read-only version of the inputs and predicted values. This allows you to examine your modeling data and inputs using all the powerful display features of the Data Editor. You can also export your modeling data to the workspace or Excel. Also in the toolbar.
- **Response Feature Data** — Opens the Data Editor, where you can view a read-only version of the values of all the response features for the local models. You can also use the Data Editor export facilities.
- **Record numbers** — Toggles the display of record numbers on plots.
- **Next Test, Previous Test, and Select Test** — Duplicate the buttons for changing tests above the plots in the top left of the **Local Model** display pane.

Calculating Two-Stage Models and Response Features

The Response Features List at the bottom of the local view shows a list of all the response features calculated for the local model.

To calculate a two-stage model, click the **Select** button in the Response Features List pane. The Model Selection window opens. This step is required before two-stage models can be calculated. A two-stage model using the local and global models is formed by using **Select**. After calculating the two-stage model, you can compare the local fit and the two-stage fit on the local level plots.

The list view displays the number of parameters and observations, the value of any Box-Cox transformation (1 indicates no transform), and the values of RMSE and PRESS RMSE (linear models only) for each response

feature model. For definitions of RMSE and PRESS RMSE, see Summary Table on page 6-30. For information on Box-Cox transforms, see “Box-Cox Transformation” on page 6-100.

Click **New** to add a new response feature model (or **Delete** to remove one). For more information see the “View and Add Test Plans” on page 2-5. The contents of this pane change in different views; it always contains the child nodes of the node selected in the “Navigate the Model Tree” on page 2-26 (and the **New**, **Delete**, and Select buttons). At the local level it contains a list of response features.

Examine Global Models

In this section...

- “What Is Global Level?” on page 6-26
- “Global Special Plots” on page 6-28
- “Global Scatter Plots” on page 6-29
- “Removed Data Pane” on page 6-31
- “Models List” on page 6-32
- “Global Level: Toolbar” on page 6-33
- “Global Level: Model-Specific Tools” on page 6-34
- “Global Level: Menus” on page 6-37

What Is Global Level?

When you select a response feature node or one-stage model node in the model tree, this view appears. Both kinds of models have a global icon (), to reflect the fact that a global model is fitted, so this is referred to as *global level*. Plots shown here are referred to as global plots. Child nodes of these models also have global icons. Any node with a global icon produces this view.

For one-stage models, this view shows the functionality available at all model nodes. For two-stage models there are other levels with different functionality for local level and response level models.

This view is similar in format to the local level view, which also contains scatter plots above special plots. The statistical information panes on the right side are different, there is a **Removed Data** pane, and there are no test number controls. There is an edit box for model comments. See also:

- Summary Table on page 6-30
- ANOVA Table on page 6-31
- “Models Comments” on page 6-32

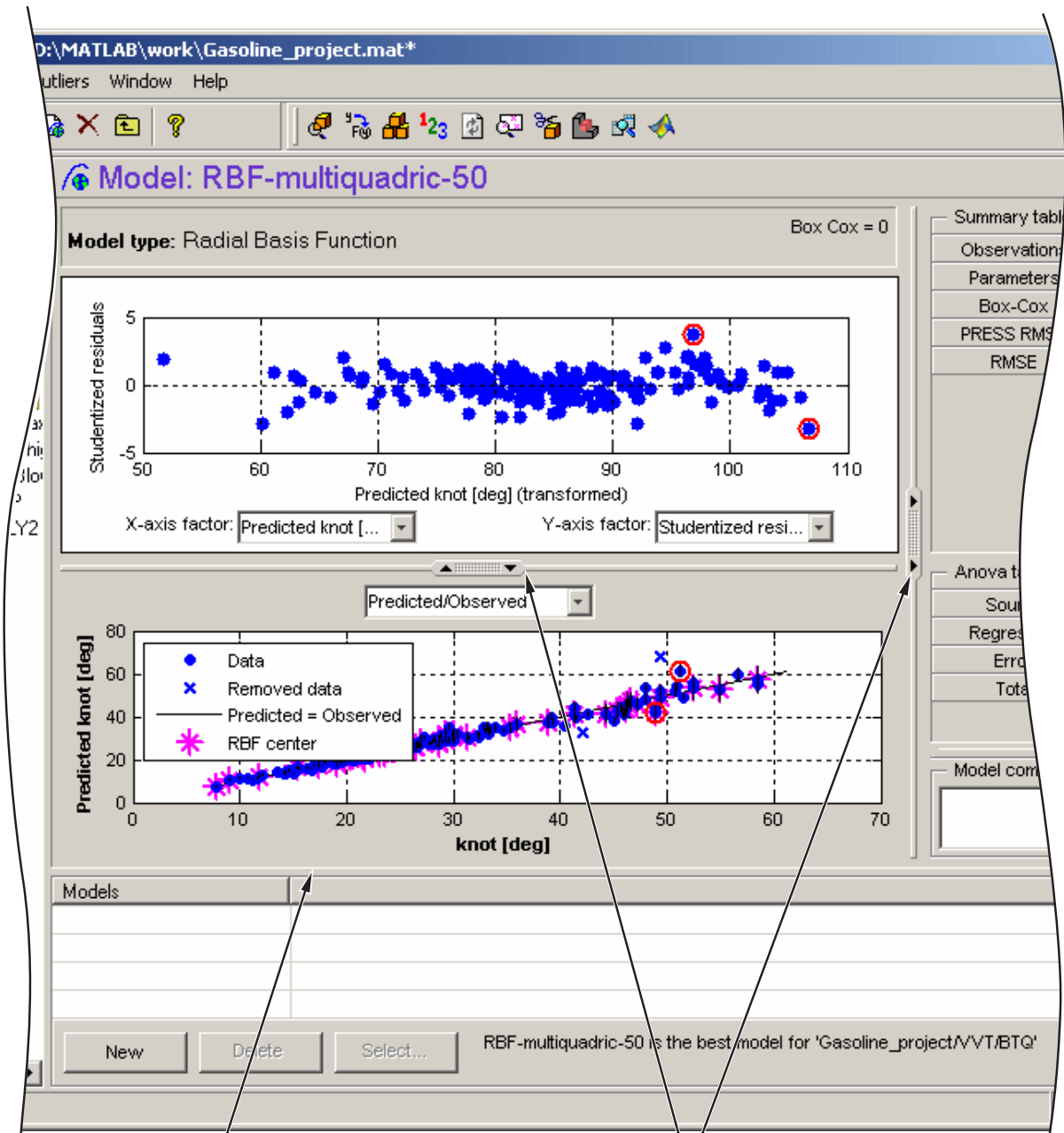

Click-and-drag anywhere along this line to change the size of the Response Features pane

Click-and-drag or double-click here to expand plots/hide statistics pane

Global Special Plots

The lower plots in the global level view are referred to as *special plots*, as they can be different for different models (for example, none at all for neural net models).

The special plot at the global level shows a Predicted/Observed plot. Where there is only one input factor, the plot shows the model fit and the data against the input factor (as in most local model special plots, which often have only one input factor).

For response feature models, each data point is the value taken by this response feature for some local model fit (of this two-stage model). Note that response features are not necessarily coefficients of the local curves, but are always derived from them in some way.

When there is more than one input factor it becomes impossible to display the fit in the same way, so the data for the response feature is plotted against the values predicted by the global model. The line of *predicted=observed* is shown. With a perfect fit, each point would be exactly on this line. The distances of the points from the line (the residuals) show how well the model fits the data.

To examine the fit in more detail, double-click the arrows (indicated in the figure in “Examine Global Models” on page 6-26) to hide the scatter plot and expand the lower plot. You can also zoom in on parts of the plot by **Shift**-click-dragging or middle-click-dragging on the place of interest on the plot. Return to full size by double-clicking.

Note Right-click a point in either the special or scatter plot to open a figure plot of that particular test (for example, torque against spark).

You can select the plot type from the drop-down menu at the top of the plot. Choices here can be:

- Predicted/Observed
- Normal Plot Normal plots are a useful graph for assessing whether data comes from a normal distribution. For more information, see “Normal Probability Plots” in the Statistics Toolbox documentation.

- **Validation Residuals** — This option is only available if you are viewing a one-stage model. If you are using validation data, the plot shows the one-stage model validation residuals. Validation data must be attached at the “Use Test Plans to Set Up Designs, Data, and Models” on page 2-15. See “Using Validation Data” on page 6-84.
- **Surface and Contour** are only available for models with two inputs. You can view a surface or contour plot with data points.

Global Scatter Plots

The upper plots in the global level view are referred to as *scatter plots*. They can show various scatter plots of statistics for assessing goodness-of-fit for the current model shown. The upper scatter plots are replaced by an icon if you resize the Browser too small.

The statistics available for plotting are model dependent.

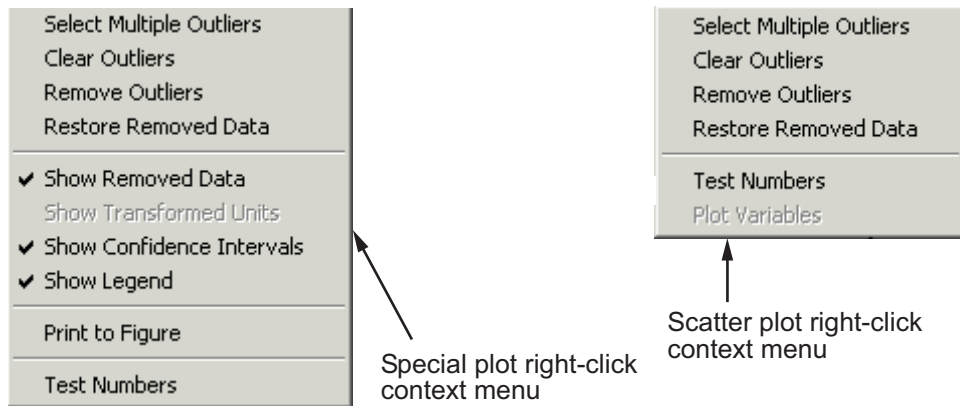

The preceding are the context menus for both plots. On both plots you can manipulate outliers with all the same commands available in the **Outliers** menu except **Outlier Selection Criteria** and **Copy Outliers**. See “Outliers Menu (Local Level)” on page 6-13 for details. For one-stage models you can select **Plot Variables** on the scatter plot.

You can choose the x- and y-axis factors using the drop-down menus. The available statistics and factors are model dependent. Following is an example.

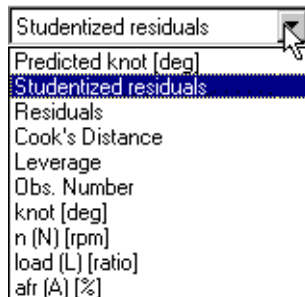

Shown is an example drop-down menu on the scatter plot for changing x and y factors. In this example `knot` is the response feature node selected. Therefore the model output is `knot`, so `knot` and `Predicted knot` are available in the menu. (For child nodes of `knot`, the model output is still `knot`.) The global inputs, the model output, and the predicted model output are always available in these menus. The observation number is also always available.

The other options are statistics that are model dependent, and can include: Residuals, Weighted Residuals, Studentized Residuals, Leverage, and Cook's Distance. These statistics and the other factors are also used as the available criteria for selection of outliers, so the options in the Outlier Selection Criteria dialog box are similarly model dependent. At global (or one-stage) level these are externally studentized residuals.

Summary Table

Observations	Number of observations used to estimate model
Parameters	Number of parameters in model
Box-Cox	Power transform used for box-cox transformation. A value of zero means a log transform is used. A value of 1 means there is no transformation.
PRESS RMSE	Root mean squared error of predicted errors. The divisor used for PRESS RMSE is the number of observations. The residuals are in untransformed values to enable comparison between alternative models with different Box-Cox transformations.

Summary Table (Continued)

RMSE	Root mean squared error. The divisor used for RMSE is the number of observations minus the number of parameters. The residuals are in untransformed values, to enable comparison between alternative models with different Box-Cox transformations.
Validation RMSE (one-stage models only)	Root mean squared error between the one-stage model and the validation data. See “Using Validation Data” on page 6-84.

Select **Model > Summary Statistics** to change and add to the “Summary Statistics” on page 6-69 displayed in the **Summary Table**.

ANOVA Table

	SS	df	MS
Regression	SSR	p-1	SSR/(p-1)
Error	SSE	n-p	SSE/(N-p)
Total	SST	n-1	

This table is not present after you have calculated MLE. See also “Toolbox Terms and Statistics Definitions” on page 6-114.

Removed Data Pane

Tests you have removed (using the **Remove Outliers** menu item) are shown in a list. Select **Outliers > Restore Removed Data** to select some or all of these to restore. Tests marked with an asterisk (*) are not restorable here (at global level). Such tests cannot be restored because the entire test has been removed at the local level (using the **Remove All Data** menu item), or the local model could not be fitted. Removed tests can only be restored at the local level.

Double-click on any removed test number to display a plot of the test in a figure window.

Models Comments

You can enter comments in the edit box.

Models List

Here is a list of any child models of the currently selected global model. This list is empty if there are no child nodes to compare. If there are child nodes you can click the **Select** button here to enter the Model Selection window to compare the child models and choose the best.

Click **New** to add a new child global model (or **Delete** to remove one). For more information see the “View and Add Test Plans” on page 2-5. The contents of this pane change in different views; it always contains the child nodes of the node selected in the model tree (and the **New**, **Delete**, and **Select** buttons). At the global level it contains a list of any child models.

The list view displays the number of parameters and observations, the value of any Box-Cox transformation (1 indicates no transform), and the values of PRESS RMSE (for linear models only) and RMSE for each child model.

If you are viewing a one-stage model and are using validation data, Validation RMSE is displayed. See “Using Validation Data” on page 6-84.

Note Note that you can specify additional statistics to display here and in the Summary table by selecting **Model > Summary Statistics**. See “Summary Statistics” on page 6-69.

Use these statistics to compare the fit of different child models and help you choose the best. For definitions of RMSE and PRESS RMSE, see Summary Table on page 6-30 and “Model Selection Guide” on page 6-64. For other statistics see “Model Menu (Global Level)” on page 6-37. For information on Box-Cox transforms, see “Box-Cox Transformation” on page 6-100.

Note that the Summary Statistics settings are inherited from parent global models and from the test plan level *only if* set before the current node was created, when they also appear in the bottom list pane if there are child nodes to compare.

Global Level: Toolbar

This toolbar appears when a response feature node or one-stage model node (both have a global icon) is selected in the model tree. Note that for one-stage models all model child nodes of the one-stage test plan are of this type.

Further buttons appear on the right depending on the type of model at the node selected. See “Global Level: Model-Specific Tools” on page 6-34.

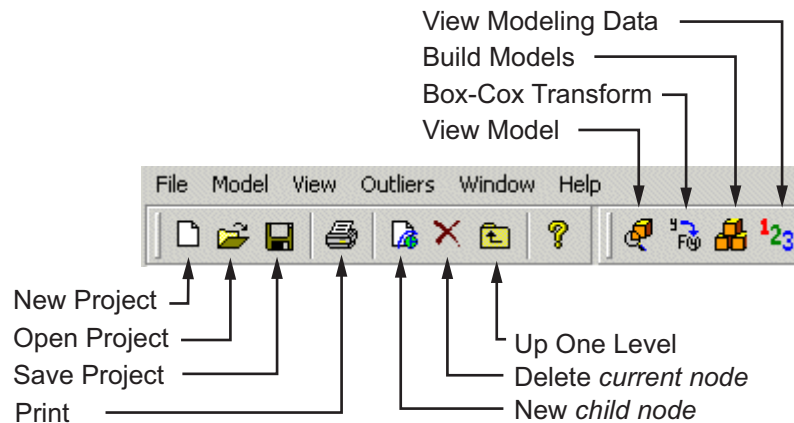

The eight left icons remain constant throughout the levels. They are for project and node management, Help, and here the print icon is enabled, as there are plots in this view. See “Use Project Tools” on page 2-7 for details on these buttons.

- View Model — Opens a dialog box displaying the terms in the current model. See “Model Definition Dialog Box” on page 6-39.
- Box-Cox Transform — Opens the Box-Cox Transformation plots, where you can minimize SSE to try to improve the fit. See “Box-Cox Transformation” on page 6-100 for statistical details.
- Build Models — Opens the “Build Alternative Models to Compare” on page 5-90, where you can choose a template for the type of models you want to build. There are predefined templates for polynomials, RBFs and hybrid RBFs, and free knot splines, you can create new templates, and you can use any suitable parent node in the current project as a template. You can also save templates of whatever models you choose using the **Model > Make**

Template menu item. User-defined templates can then be found via the Build Models dialog box. You can use the Browse button to find stored templates that are not in the default directory.

- View Modeling Data — Opens the Data Editor, where you can view a read-only version of the inputs, predicted and actual responses. This allows you to examine and export your modeling data, using all the powerful display features of the Data Editor. Also in the **View** menu.

These four toolbar icons appear for every global model node (although Box-Cox is not enabled for neural net models). The icons that appear to the right are model specific.

Global Level: Model-Specific Tools

All twelve left buttons (up to View Modeling Data) appear for all response feature models and one-stage models. See “Global Level: Toolbar” on page 6-33 for details on these buttons. The right buttons change according to model type.

Linear Model and Multiple Linear Models

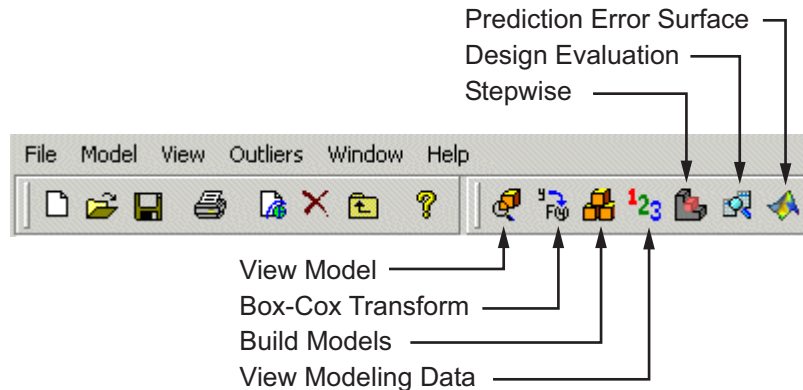

- Stepwise — This opens the Stepwise Regression window, where you can view the effects of removing and restoring model terms on the PRESS statistic (Predicted Error Sum of Squares), which is a measure of the predictive quality of a model. You can also use Min PRESS to remove all

at once model terms that do not improve the predictive qualities of the model. See “Stepwise Regression” on page 6-87 for further discussion of the statistical effects of the Stepwise feature.

- Design Evaluation — Opens the Design Evaluation tool, where you can view properties of the design. See “Design Evaluation Tool” on page 3-71.
- Prediction Error Variance Viewer - Opens the Prediction Error Variance Viewer. See “Prediction Error Variance Viewer” on page 3-63.

Free-Knot Spline Models

Free knot spline models do not have any model-specific tools, just the standard View Model, Box-Cox Transform, Build Models and View Modeling Data.

Radial Basis Function Models

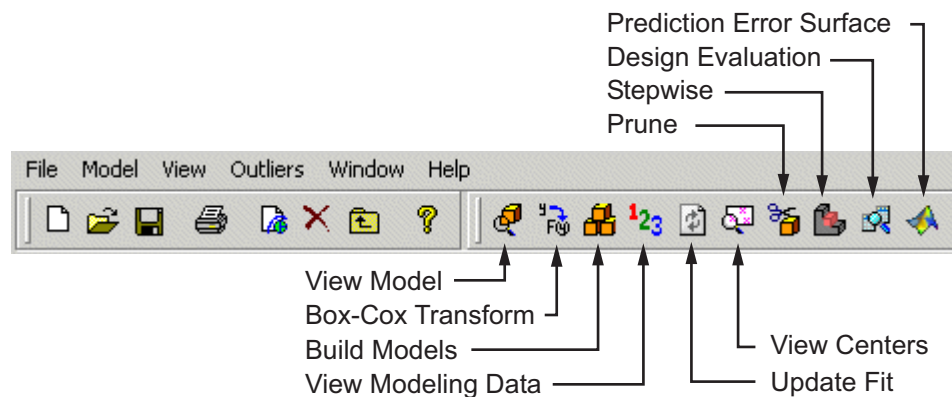

- Update Fit refits the RBF widths and centers. See “Tips for Modeling with Radial Basis Functions” on page 7-33 and “Fitting Routines” on page 7-11 in the Radial Basis Functions chapter.
- View Centers opens a dialog box where you can view the position of the radial basis function’s centers graphically and in table form.
- Prune opens the Number of Centers Selector where you can minimize various error statistics by decreasing the number of centers. See “Prune Functionality” on page 7-25.
- Stepwise opens the Stepwise Regression window.

- Design Evaluation - Opens the Design Evaluation tool, where you can view properties of the design. See “Design Evaluation Tool” on page 3-71.
- Prediction Error Variance Viewer - Opens the “Prediction Error Variance Viewer” on page 3-63.

Hybrid RBFs have the same toolbar buttons as linear models.

MLE Models

This toolbar appears when you select any response feature that is an MLE model (purple icon). See “Examine Global Models” on page 6-26 for other functionality in this view.

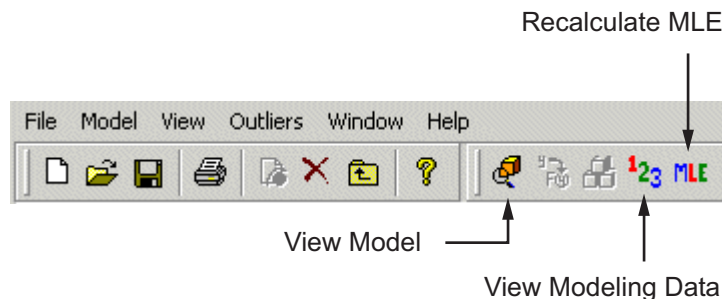

At this point the New child node, Box-Cox and Build Models buttons are disabled.

- Recalculate MLE returns to the MLE dialog box, where you can perform more iterations to try to refine the MLE model fit. See “Calculate and Compare MLE” on page 6-75 for more details.

Neural Networks

Neural net models have the View Model, Build Models, and Update Fit tools.

Global Level: Menus

File

Only the **New** (child node) and **Delete** (current node) functions change according to the node level currently selected. Otherwise the **File** menu remains constant.

See “File Menu” on page 2-8.

Window and Help Menus

The **Window** and **Help** menus have the same form throughout the Model Browser.

See “Window Menu” on page 2-10 and “Help Menu” on page 2-10.

Model Menu (Global Level)

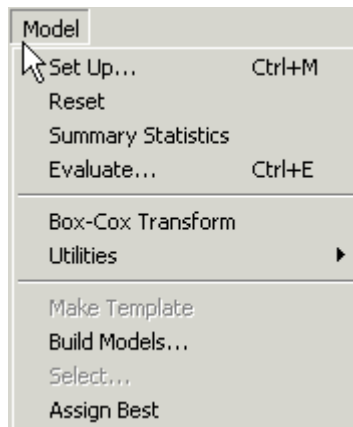

- **Set Up** opens the Global Model Setup dialog box, where you can change the model type. See “Global Model Setup” on page 5-66.
- **Reset** opens a confirmation dialog box so you cannot unintentionally reset your model. When you confirm you want to continue, the model is reset to the global model default, that is, the global model specified at the test plan stage, restoring any removed outliers and removing any transforms.

- **Summary Statistics** opens the Summary Statistics dialog box where you can select which statistics to display to help you evaluate models. In the global level view these appear in the **Summary Table** to the right of the plots, and in the **Models** list pane if there are child node models to compare. They also appear in the Model Selection window, and can be used to automatically select the best child node when using the Build Models dialog box and Local Multiple Models. The standard summary statistics are PRESS RMSE (for linear models only) and RMSE, and these are always displayed. You can choose additional statistics for display in the Summary Statistics dialog box by selecting the check boxes. You can also reach the dialog box from the test plan. When you create child nodes the selected summary statistics are inherited. See “Summary Statistics” on page 6-69 for more information.
- **Evaluate** — Select from the submenu **Fit Data, Validation Data, No Data, or Other Data**. Opens the Model Evaluation window displaying the fit relative to the selected data (or no data). You must attach validation data to the test plan before you can use it. If you select **Other Data** a wizard appears to select the data.
- **Box-Cox Transform** opens the Box-Cox Transformation plots, where you can minimize SSE to try to improve the fit. See “Box-Cox Transformation” on page 6-100 for statistical details.
- **Utilities** opens a submenu showing the model-specific options available, duplicating the model-specific toolbar buttons (for example, Stepwise, Design Evaluation, View Centers, Prediction Error Variance Viewer, and so on).
- **Make Template** is available when child nodes exist. This opens a file browser where you can choose to save all the current child node models as a template, which you can then access using the Build Models menu item or toolbar button.
- **Build Models** opens the Build Models dialog box. Here you can create a template, use a predefined template, or use current models as a template to build a selection of models as child nodes of the current node (or for local models, as child nodes of each response feature). The best model of each selection of child nodes will be automatically selected (it will have a blue icon), based on the selection criteria you choose in the following dialog box (such as PRESS RMSE, RMSE, Box-Cox, Observations or Parameters).

See “Build Alternative Models to Compare” on page 5-90 for details.

- **Select** is available whenever the **Select** button is also enabled in the lower right pane (when it is titled **Local Models**, **Response Features**, or **Models**). This item opens the Model Selection window to allow you to choose the best model. See “Comparing Models” on page 6-42.
- **Assign Best** selects the current model as best. If it is one of several child node models of a global model, selecting it as best means that it is duplicated at the parent global model. See “Navigate the Model Tree” on page 2-26.

View Menu (Global Level)

- **Model Definition** opens the Model Definition dialog box displaying the model terms. See “Model Definition Dialog Box” on page 6-39.
- **Modeling Data** opens the Data Editor to display a read only version of the inputs and predicted and actual responses. Here you can view and export your modeling data. Also in the toolbar.
- **Test Numbers** turns test numbers on and off for both the special and scatter plots. Also available in the right-click plot menus.

Model Definition Dialog Box. You can open this dialog box for any model to view the parameters and coefficients of the model formula and the coding details. You can view the Model Definition dialog box at the local, global, and response levels. For any radial basis function model you can see the kernel type, number of centers, width, and regularization parameter, as shown in the following example.

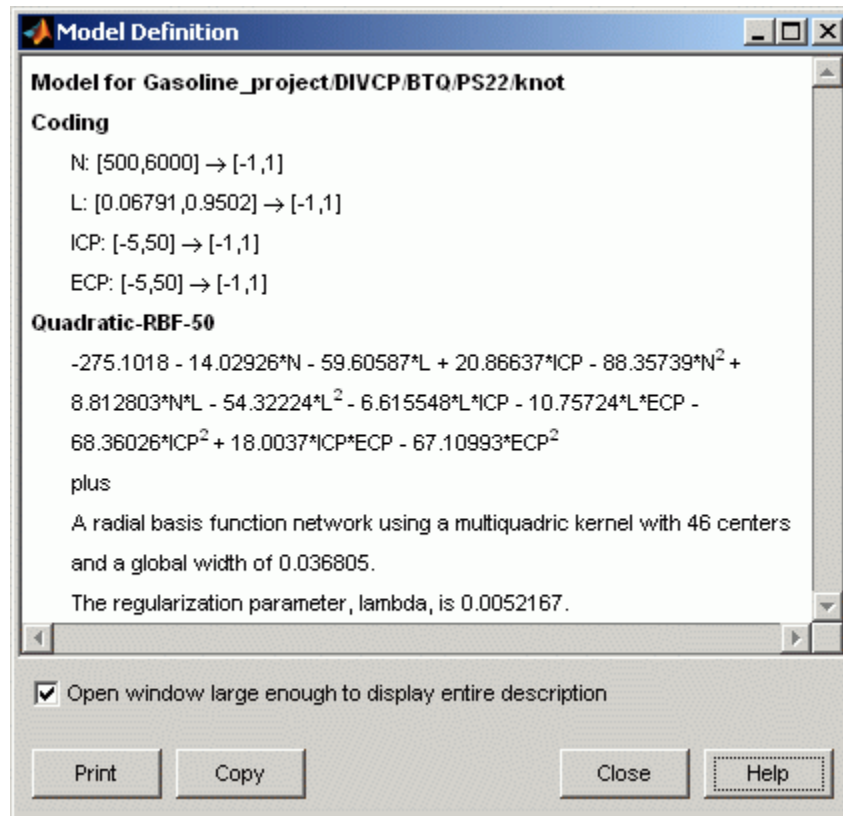

For radial basis function models, see also “How to Find RBF Model Formula” on page 7-39.

Outliers Menu (Global Level)

This is the same as the local level **Outliers** menu, except that there is no **Remove All Data** command. All items are duplicated in the right-click context menu on the plots, except **Selection Criteria** and **Copy Outliers**. See “Outliers Menu (Local Level)” on page 6-13.

At global level, as at local level, the **Restore Removed Data** item opens the Restore Removed Data dialog box, where you can choose the points to restore from the list, or restore all available points. Select points in the left

list and use the buttons to move points between the lists. Note that entire tests removed at the local level (using the **Remove All Data** item) cannot be restored at global level.

Compare and Select Best Models

In this section...
“Comparing Models” on page 6-42
“Select a Best Model” on page 6-44
“Plots and Statistics for Comparing Models” on page 6-44

Comparing Models

Use the Model Selection window to help you select a best model by comparing several candidate models. Click the **Select** button to open the Model Selection window and compare the child nodes of your current view.

The **Select** button is under the list view in the pane at the bottom of the Model Browser display. This pane is the Test Plans list pane at startup and changes title depending on the level in the model tree that is selected. The list box in this pane always contains the child nodes of whichever node in the tree is selected.

The pane also always contains three buttons: **New**, **Delete**, and **Select**.

Select is only available when the lower pane lists local models, response models, or models.

You can select among the following:

- Local models
- Response features
- Submodels of response features

However, you cannot select between response models or test plans.

Note To get a two-stage model at the response node, you must use the **Select** button at the local node (when the lower pane is the **Response Features** pane) to assign a model (even if it is the only one) as best. This step then calculates the two-stage model.

Select might not be available if you are not ready to choose among the child nodes. For example, at the response node, the child nodes must have models assigned as best (using the **Select** feature at those levels) before you can select among them. Also, if a response feature has child nodes of alternate models, you must select the best, or the Browser cannot tell which to use to calculate that response feature. After calculating MLE, **Select** compares the MLE model with the previous univariate model, and you can choose the best.

Use the Model Selection window for visual comparison of several models. From the response level you can compare several two-stage models. From the local level, if you have added new response features you can compare the different two-stage models (constructed using different combinations of response feature models). If you have added child nodes to response feature models, you can compare them all using the Model Selection window.

When a model is selected as best it is copied up a level in the tree together with the outliers for that model fit.

A tree node is automatically selected as best if it is the only child, except two-stage models which are never automatically selected - you must use the Model Selection window.

If a best model node is changed the parent node loses best model status (but the automatic selection process will reselect that best model if it is the only child node).

Note You can bypass the Model Selection window if you want to quickly assign a model as best (unless you need to calculate a two-stage model). Select the model node in the tree, then select **Model > Assign Best**.

Select a Best Model

In the Model Selection window, click the **Assign Best** button at the bottom of the window to mark the currently selected model as best, or you can double-click a model in the list.

To choose which model to select as best, use the plots and statistics in the Model Selection window described in the next section. To determine the best fit, you should examine both the graphical and numerical fit results. When you can no longer eliminate fits by examining them graphically, you should examine the statistics. For guidance on how to use the statistics for assessing models, see “Model Selection Guide” on page 6-64.

Plots and Statistics for Comparing Models

You can display several different views in the Model Selection window, depending on the type of models you are comparing:

- “Tests View” on page 6-46
- “Predicted/Observed View” on page 6-49
- “Response Surface View” on page 6-51
- “Likelihood View” on page 6-55
- “RMSE View” on page 6-57
- “Residuals View” on page 6-59
- “Cross Section View” on page 6-60

You can change to any available view in the Model Selection window using the **View** menu or by clicking the buttons of the toolbar.

Information about each candidate model is displayed in the list at the bottom. The information includes categories such as the number of observations and parameters, and various diagnostic statistics such as RMSE and PRESS RMSE. You can click on column headers in this list to sort models by that category — for example, clicking on the column header for PRESS RMSE sorts the models in order of increasing PRESS RMSE. As this statistic is an indication of the predictive power of the model, it is a useful diagnostic statistic to look at (the lower the better), but remember to also look at other factors.

Note The diagnostic statistics displayed depend on your choices in the Summary Statistics dialog box for the parent model node. See “Summary Statistics” on page 6-69 for details.

To print the current view, use the **File > Print** menu item or its hot key equivalent **Ctrl+P**. In the Response Surface view you can also use the right-click context menu.

To close the Model Selection window, use the **File > Close** menu item or its hot key equivalent **Ctrl+W**. Model Selection is intended to help you select a best model by comparing several candidate models, so when you close the window you are asked to confirm the model you chose as best.

See also “Evaluate Model Fit” on page 6-82, which includes some of the same views you see in the Model Selection window, and where you can use validation data.

Tests View

For a two-stage model the initial view is as follows:

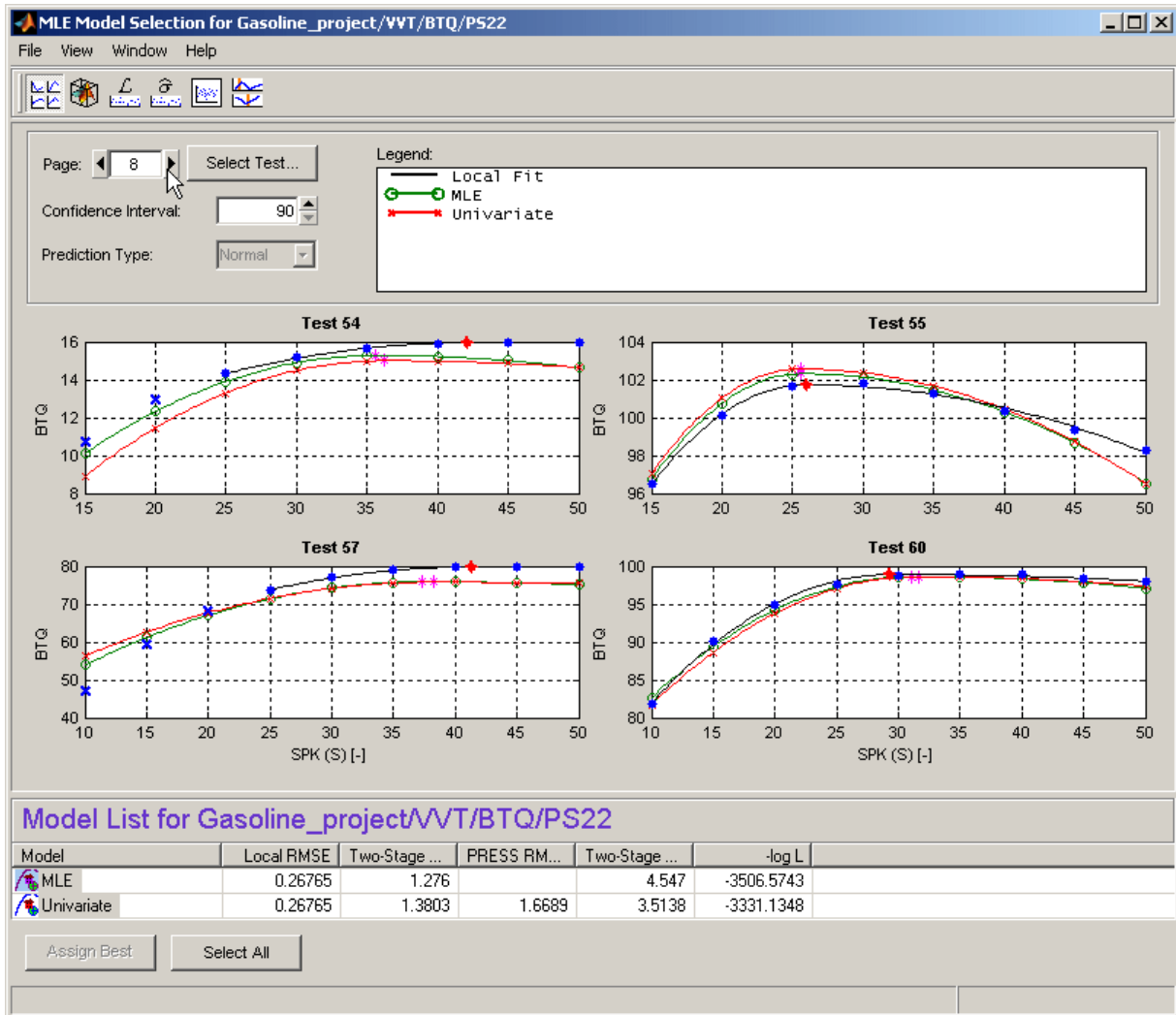

The tests view shows the data being modeled (blue dots) and models that have been fitted to this data. The black line shows the local model that has been fitted to each test separately. The green line and red lines in this case show

an MLE two-stage model and the Univariate two-stage model: you can see the local model curves reconstructed using response feature values taken from the global models, and compare the fits.

This view allows you to compare several models simultaneously. Using standard Windows multiselect behavior (**Shift**+click and **Ctrl**+click) in the list view, or by clicking the **Select All** button, you can view several two-stage models together. A maximum of five models can be selected at once. The legend allows you to identify the different plot lines.

If the local input has more than one factor, a “Predicted/Observed View” on page 6-49 appears instead.

Clicking one of the plots (and holding the mouse button down) displays information about the data for that test. For example:

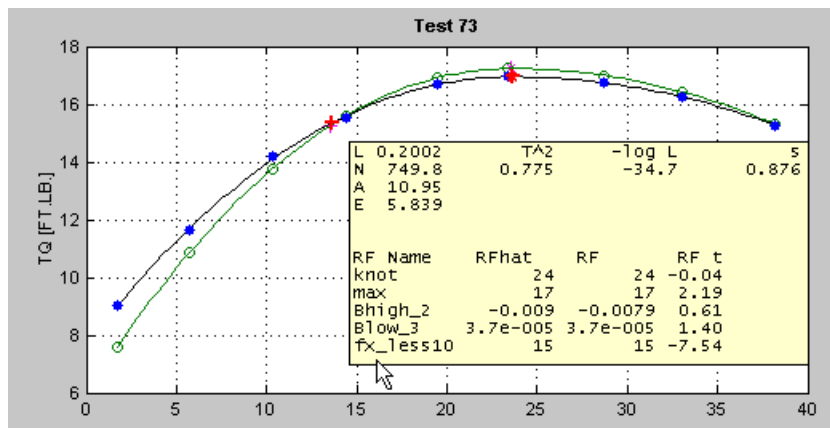

Here you see the values of the global variables for this test and some diagnostic statistics describing the model fit. Also displayed are the values (for this test) of the response features used to build this two-stage model and the two-stage model’s estimation of these response features.

The controls allow navigation between tests.

You can change the size of the confidence intervals; these are displayed using a right-click menu on the plots themselves.

The prediction type allows a choice of Normal or PRESS (Predicted Error Sum of Squares) — although not if you entered this view through model evaluation (rather than model selection). PRESS predictions give an indication of the model fit if that test was not used in fitting the model. For more on PRESS see “PRESS statistic” on page 6-97, Summary Table on page 6-30, and “Stepwise Regression” on page 6-87.

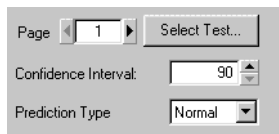

The image shows a control panel with the following elements:

- A "Page" label followed by a left arrow, the number "1", and a right arrow.
- A "Select Test..." button.
- A "Confidence Interval:" label followed by a text box containing "90" and a vertical spinner.
- A "Prediction Type" label followed by a dropdown menu showing "Normal".

Predicted/Observed View

For a one-stage model, or when you are comparing different models for one Response Feature, the initial view is as follows:

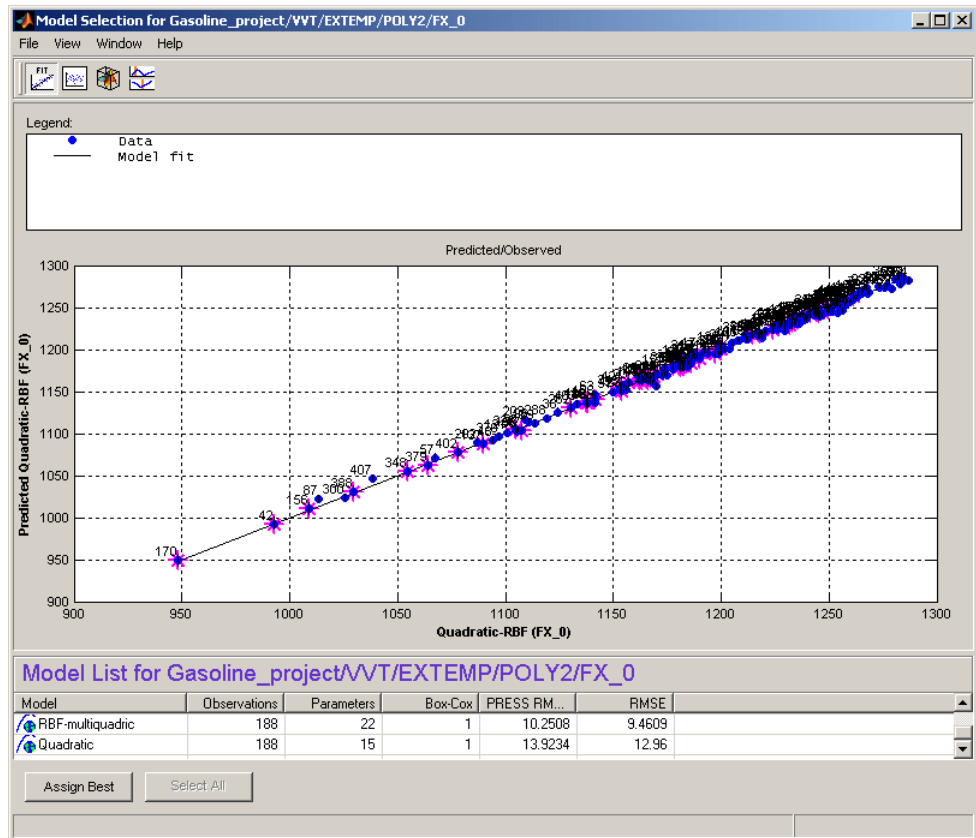

The plot shows the data used to fit this model, against the predicted values found by evaluating the model at these data points. The straight black line is the plot of $y=x$. If the model fitted the data exactly, all the blue points would lie on this line. The error bars show the 95% confidence interval of the model fit.

For single inputs, the response is plotted directly against the input.

The Predicted/Observed view only allows single selection of models for display. Right-click to toggle test number display, as you can on most plots.

Response Surface View

This view shows the model surface in a variety of ways.

Model Selection for Gasoline_project/DIVCP/BTQ/PS22/Bhigh_2

File View Window Help

FIT 3D 2D 1D

Input factors:

N: 2700
L: 0.25
ICP Min: -5 Max: 50 Pts: 101
ECP Min: -5 Max: 50 Pts: 101

Display boundary constraint

Display type:
Surface Plot
Movie

Prediction Error shading
Prediction Error threshold:

Export model values:
 Export to workspace
 Export to mat file...
Save input as: Save result as:

Bhigh_2 $\times 10^{-3}$

INT_ADV (ICP) [DegCrank]

EXH_RET (ECP) [DegCrank]

X-axis factor: ICP
Y-axis factor: ECP

Model List for Gasoline_project/DIVCP/BTQ/PS22/Bhigh_2

Model	Observations	Parameters	Box-Cox	PRESS	RMSE	AICc	cond(J)
RBF-recmultiquadric-80	186	69	1	0.00229	0.0016264	-2257.9889	240.4171
RBF-multiquadric-60	186	45	1	0.0024403	0.0021263	-2223.9896	1091.2643

Ready

The default view is a 3-D plot of the model surface, as in the example. This model has five dependent factors; you can see these in the controls at the top left (there is a scroll bar as only four can be seen at once at this size of window).

You can choose which input factors to display by using the drop-down menus below the plot. The unselected input factors are held constant and you can change their values using the controls at the top left of the view (either by clicking the arrow buttons or by typing directly in the edit box).

Display using (S - datum) — If a datum model is being displayed, this check box appears. The datum variable here is spark angle, S. When you select this box, the model is displayed in terms of spark angle relative to the datum. The appropriate local variable name appears here. See “Datum Models” on page 5-88.

Display boundary constraint — If you have boundary models you can display them by selecting the check box. Areas outside the boundary are yellow, as shown in the example. Areas outside the boundary are yellow (or gray in table view). They are shown on all display types (contour, 2-D, surface, movie and table).

Display Type— Changes the model plot. Display options are available for some of these views and are described under the relevant view. The choices are as follows:

- A table showing the model evaluated at a series of input factor values.
- A 2-D plot against one input factor.
- A 2-D plot with several lines on it (called a multiline plot); this shows variation against two input factors.
- A contour plot.

The **Contours.** button opens the Contour Values dialog box. Here you can set the number, position, and coloring of contour lines.

Fill Contour colors each space between contours a different color.

Contour Labels toggles the contour value numbers on and off. Without labels a color bar is shown to give you a scale.

Auto (the default) automatically generates contours across the model range.

N Contour Lines opens an edit box where you can enter any number of contour lines you want.

Specify values opens an edit box where you can enter the start and end values where you want contour lines to appear, separated by a colon. For example, entering 5:15 gives you 10 contour lines from 5 to 15. You can also enter the interval between the start and end values; for example 1:100:600 gives you contour lines between 1 and 600 at intervals of 100.

- A surface (shown in the example).

Prediction Error shading — Colors the surface in terms of the prediction error (sqrt (Prediction Error Variance)) of the model at each point. A color bar appears, to show the value associated with each color.

Note For datum models, Prediction Error shading is only available when the **Display using** (*local variable - datum*) check box is not selected.

Prediction Error threshold — To see good color contrast in the range of PE of interest, you can set the upper limit of the coloring range. All values above this threshold are colored as maximum P.E.

- A movie: this is a sequence of surfaces as a third input factor's value changes.
 - **Replay** replays the movie.
 - **Frame/second** selects the speed of movie replay.
 - The number of frames in the movie is defined by the number of points in the input factor control (in the array at the top left) that corresponds to the **Time factor** below the plot.

Export model values allows the currently displayed model surface to be saved to a MAT file or to the MATLAB workspace.

Right-click on the plot to reach the context menu and change many display properties (lighting, colormap etc.) and print to figure.

Within a test plan the memory is retained of the evaluation region, plot type and the number of points resolution last displayed in the Response Surface view.

Likelihood View

The likelihood view shows two plots relating to the log likelihood function evaluated at each test. It is useful for identifying problem tests for maximum likelihood estimation (MLE).

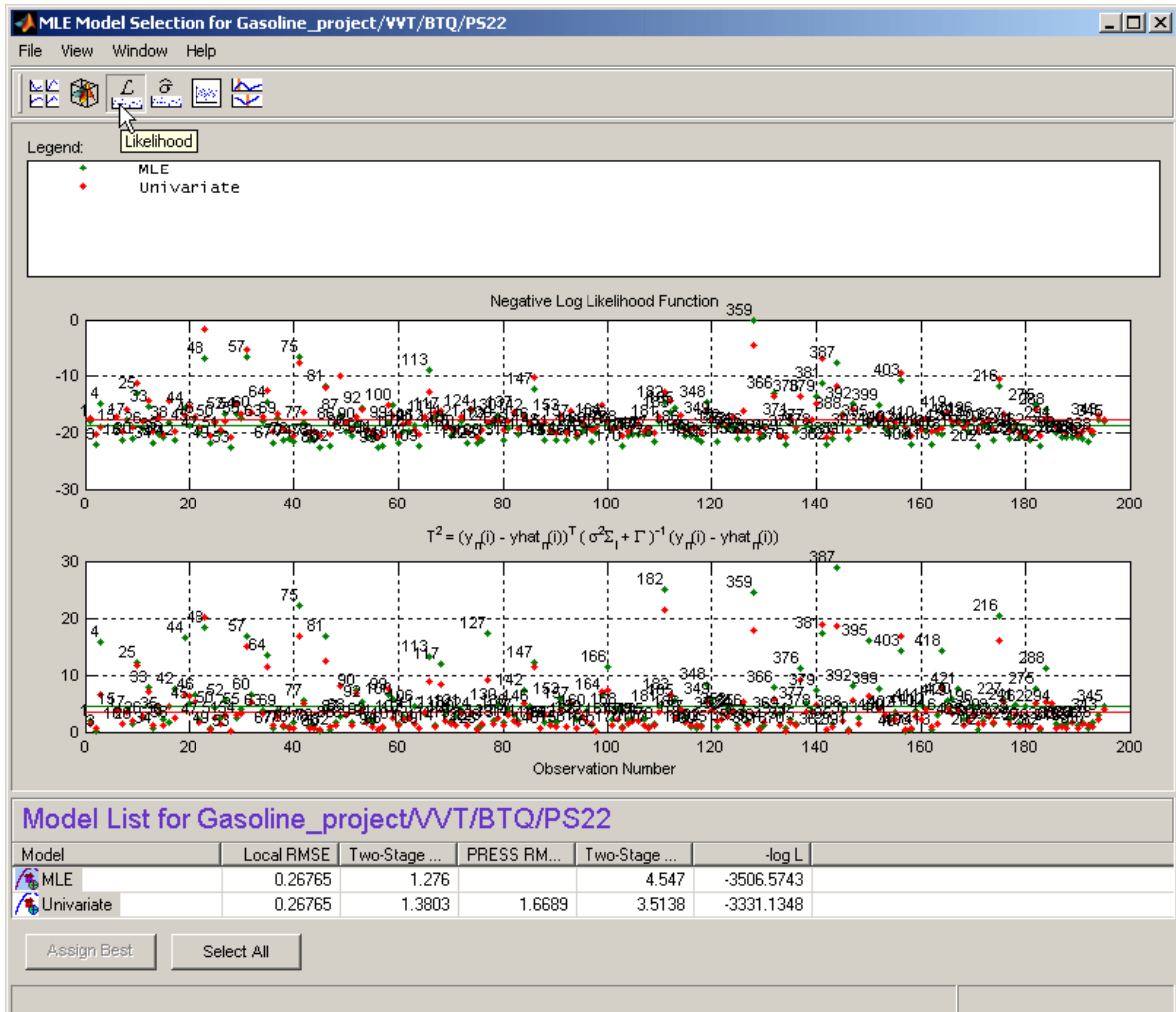

Each plot has a right-click menu that allows test numbers to be displayed on the plots and also offers autoscaling of the plots. You can also **Print to Figure**.

The likelihood view allows several models to be displayed simultaneously; click the **Select All** button at the bottom of the window or, in the model list view, **Shift**+click or **Ctrl**+click to select the models for display.

The upper plot shows values of the negative log likelihood function for each test. This shows the contribution of each test to the overall negative log likelihood function for the model, as compared with the average, as indicated by the horizontal green line.

The lower plot shows values of the T-squared statistic for each test. This is a weighted sum squared error of the response feature models for each test. As above, the purpose of this plot is to show how each test contributes to the overall T-squared statistic for this model. The horizontal line indicates the average.

RMSE View

The Root Mean Square Errors view has three different plots, each showing standard errors in the model fit for each test.

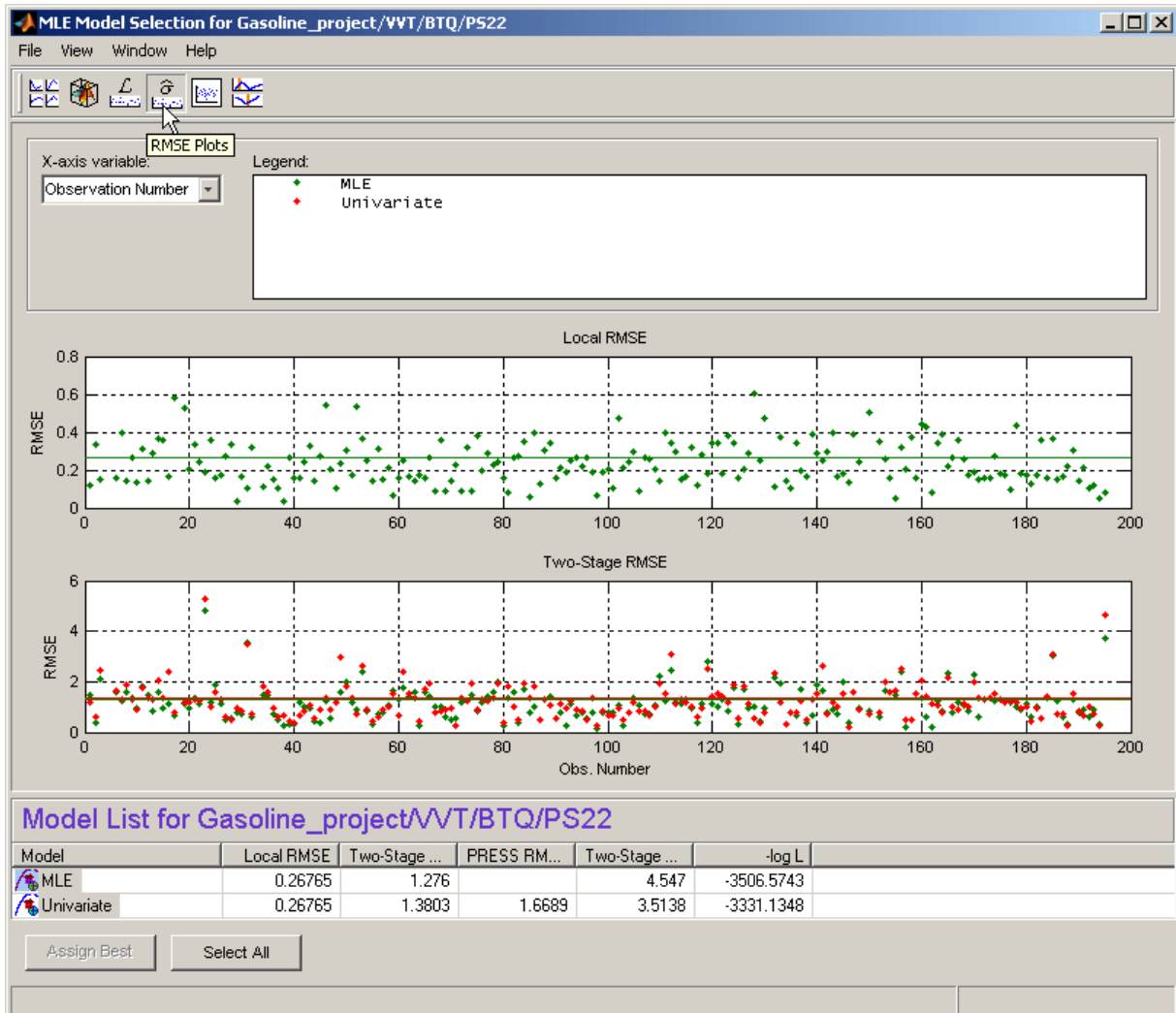

Each plot has a right-click menu that allows test numbers to be displayed on the plots, and you can **Print to Figure**.

The **X variable** menu allows you to use different variables as the x -axis of these plots.

The RMSE view allows several models to be displayed simultaneously; click the **Select All** button at the bottom of the window or, in the model list view, **Shift**+click or **Ctrl**+click to select the models for display.

Local RMSE shows the root mean squared error in the local model fit for each test.

Two-Stage RMSE shows the root mean squared error in the two-stage model fit to the data for each test. You should expect this to be higher than the local RMSE.

PRESS RMSE is available when all response feature models are linear. This plot shows the root mean squared error in the PRESS two-stage model fit at each test.

For information on PRESS RMSE see Summary Table on page 6-30 and “Model Selection Guide” on page 6-64.

Residuals View

The residuals view shows the scatter plots of observation number, predicted and observed response, input factors, and residuals.

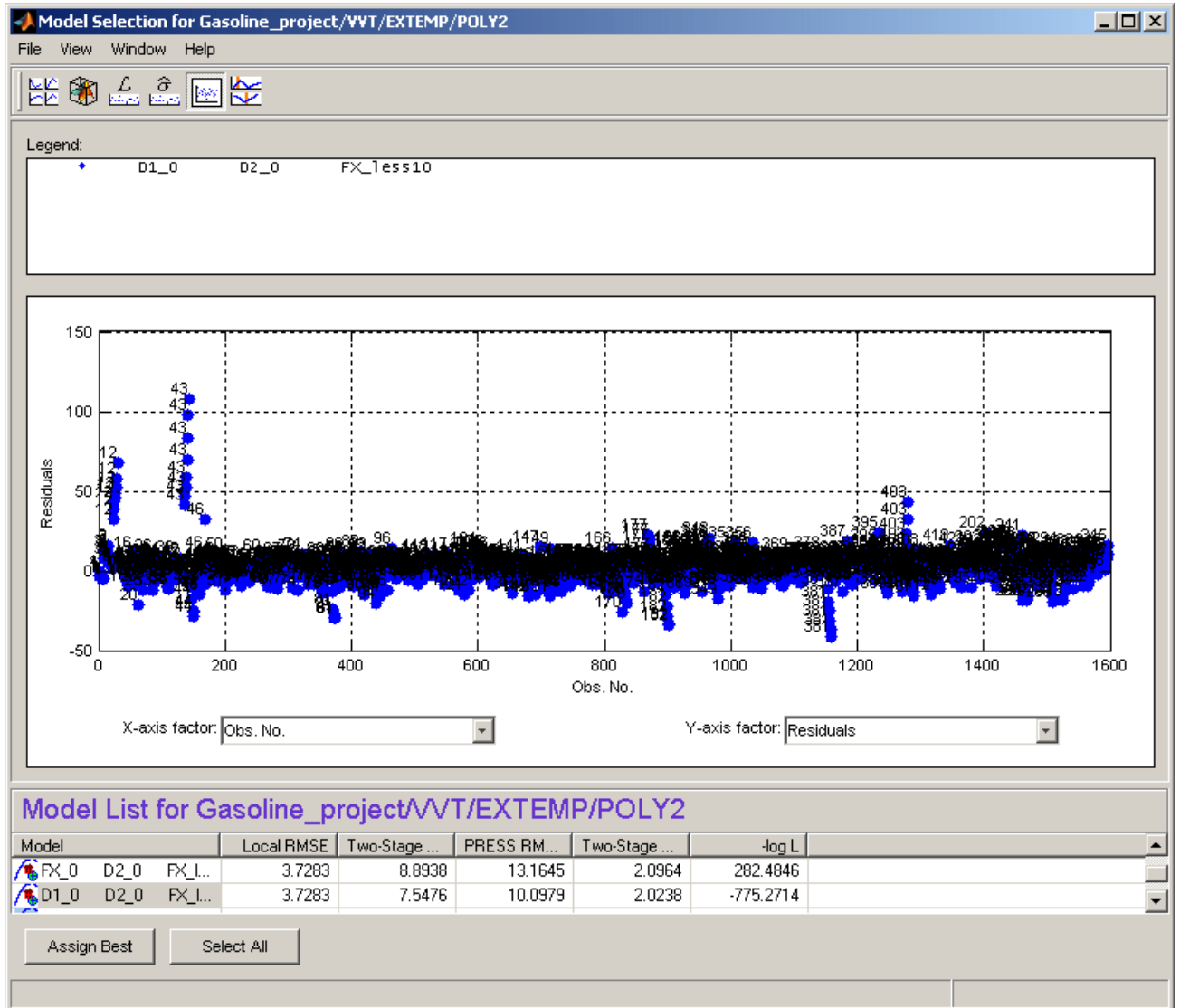

This view allows several models to be displayed simultaneously; click the **Select All** button at the bottom of the window or, in the model list view, **Shift**+click or **Ctrl**+click to select the models for display.

A right-click menu allows the test number of each point to be displayed when only one model is being displayed, as shown.

The **X-axis factor** and **Y-axis factor** menus allow you to display various statistics.

Cross Section View

The cross-section view shows an array of cross sections through the model surface. You can choose the point of cross section in each factor. Data points near cross sections are displayed, and you can alter the tolerances to determine how much data is shown. The only exception is when you evaluate a model without data; in this case no data points are displayed.

You can select individual data points by test number (using the **Select Data Point** button). You can double-click a data point in a graph to take the display directly to that point. You can choose to use a common Y-axis limit for all graphs using the check box.

If you have boundary models you can choose to display them here using the check box; regions outside the boundary are yellow, as shown in the example.

Within a test plan the memory is retained of the point last displayed in the Cross Section view; when you reopen the view you return to the same point.

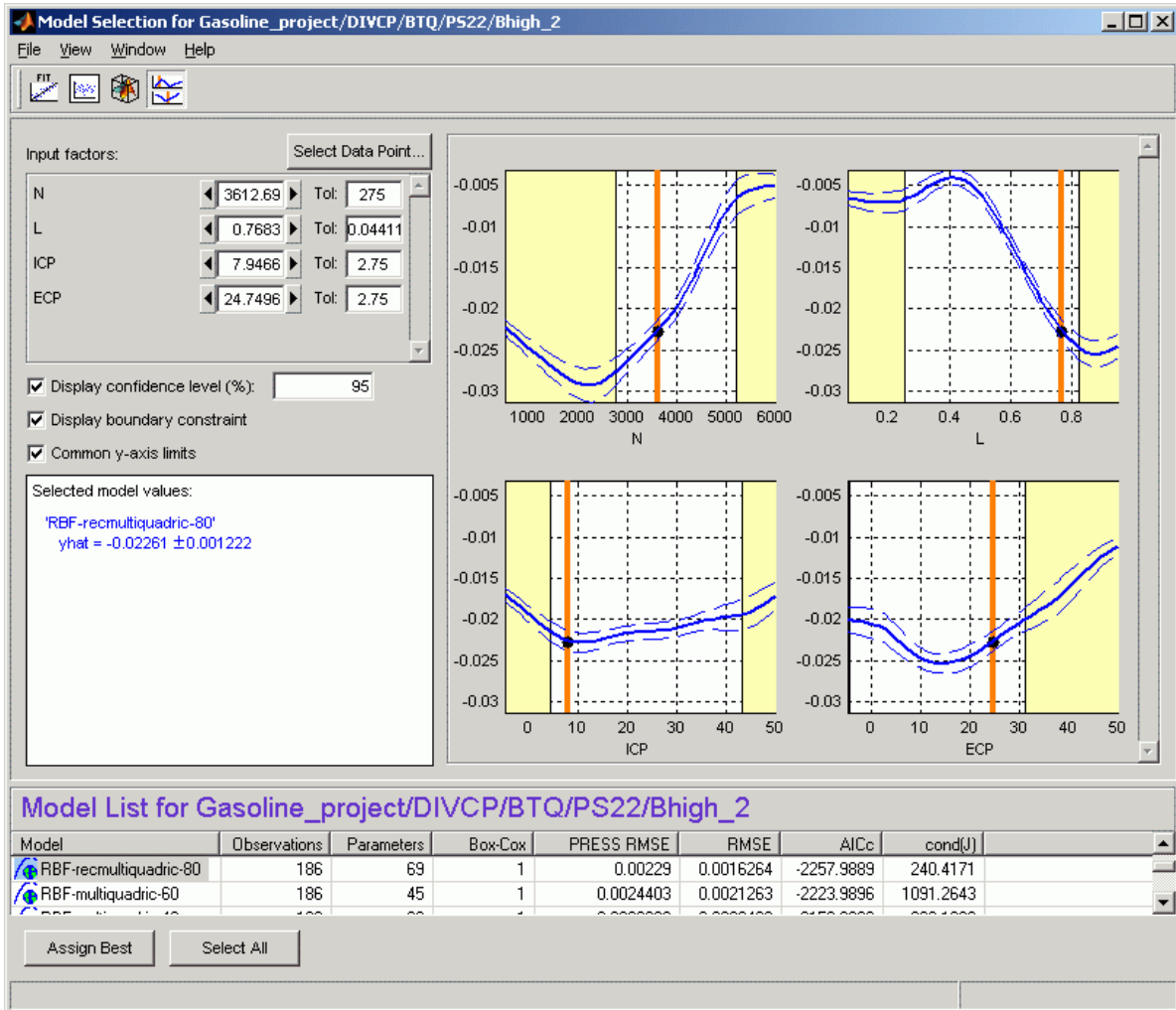

The number of plots is the same as the number of input factors to the model. The plot in S shows the value of the model for a range of values of S while the other input factors are held constant. Their values are displayed in the

controls at the top left, and are indicated on the plots by the vertical orange bars.

- You can change the values of the input factors by dragging the orange bars on the plots, using the buttons on the controls, or by typing directly into the edit boxes.
- For example, changing the value of N to 1000 (in any of these ways) does nothing to the graph of N, but all the other factor plots now show cross sections through the model surface at $N = 1000$ (and the values of the other variables shown in the controls).

On the plots, the dotted lines indicate a confidence interval around the model. You define the confidence associated with these bounding lines using the **Display confidence level (%)** edit box. You can toggle confidence intervals on and off using the check box on this control.

For each model displayed, the value of the model and the confidence interval around this are recorded in the legend at the lower left. The text colors match the plot colors. In the example shown, two models are selected for display, resulting in blue (PS22 model) and green (POLY2 model) legends on the left to correspond with the blue and green plots. You can select multiple models to display in the list at the bottom using **Ctrl+click**, or click **Select All**. The values of the input factors (for which the model is evaluated) can be found in the controls (in the **Input factors** pane) and seen as the orange lines on the plots.

Data points are displayed when they fall within the tolerance limit near each cross section. You can set the tolerance in the **Tol** edit boxes.

- For example, if N is set to 1000, and the tolerance for N is set to 500, all data points with values between $N = 500$ and $N = 1500$ appear on the plots of the other factors.
- This means that changing the tolerance in one factor affects the data points that appear on the plots of all the other factors. It does not affect the plots of that factor.
- You can click data points in the plots to see their values. Several points can mask each other; in this case the values of all coincident data points are displayed. Double-click to move the display directly to a data point.

The following example illustrates how the tolerance level determines which data points are displayed. The tolerance for TP_REL (500) includes all points in the data set (this is an extreme example). The plot for N therefore shows the data points for all the tests. Note that you can see the structure of the data as each test shows as a vertical line of points.

You can see that the orange line on the N plot passes through a test. This orange line shows the value of N for the cross-section plot of TP_REL. You can also read the value in the edit box (N=1753.3). The tolerance for N (200) only includes data points of this test. Data in adjacent tests fall outside this tolerance. Therefore the TP_REL plot shows the data points from one test only.

Increasing the tolerance on N will mean that more data points fall within the tolerance and so would appear on the TP_REL plot.

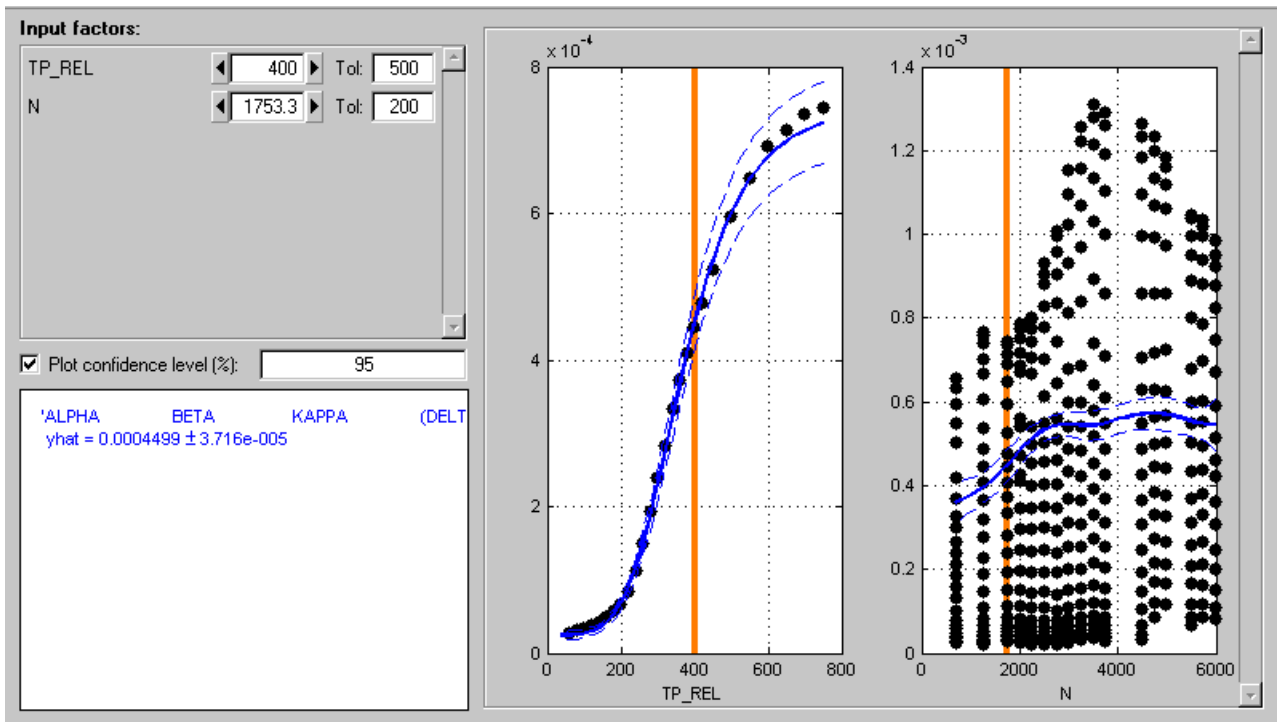

Model Selection Guide

In this section...

“Determining the Best Fit” on page 6-64

“Overfitting and Underfitting” on page 6-64

“RMSE” on page 6-65

“Other Statistics” on page 6-66

“Validation” on page 6-67

“Trends” on page 6-68

“Where to Find Statistics for Comparing Models” on page 6-68

“Summary Statistics” on page 6-69

“Using Information Criteria to Compare Models” on page 6-71

“References” on page 6-74

Determining the Best Fit

First it is important to point out that there is no recipe for model selection. It is not possible to cover the entire topic of Model Selection in a few paragraphs. Instead, we outline some general guidelines which should be helpful in using the Model-Based Calibration Toolbox product to choose the best model for a given data set. There are many books you can go to for a fuller account of statistical modeling. See “References” on page 6-74.

To choose which model to select as best, use the plots and statistics in the Model Selection window (see “Compare and Select Best Models” on page 6-42). To determine the best fit, you should examine both the graphical and numerical fit results. When you can no longer eliminate fits by examining them graphically, you should examine the statistics. The following sections provide guidance on how to use the statistics for assessing models and searching for the best fit.

Overfitting and Underfitting

When fitting a model to noisy data, we effectively make the fundamental assumption that the data have been generated from some model (the “truth”)

by making predictions at given values of the inputs, then adding some amount of noise to each point, where the noise is drawn from a normal distribution with an unknown variance.

Our task is to discover both this model and the width of the noise distribution. In doing so, we aim for a compromise between *bias*, where our model does not follow the right trend in the data (and so does not match well with the underlying truth), and *variance*, where our model fits the data points too closely, and so “chases” the noise rather than trying to capture the true trend. These two extremes are known as underfitting and overfitting.

An important concept in this context is the *number of parameters* in a model. As this number increases, the model can bend in more complicated ways. If the number of parameters in our model is larger than that in the truth, then we risk overfitting, and if our model contains fewer parameters than the truth, we could underfit.

RMSE

Our basic measure of how closely a model fits some data is the Root Mean Squared Error (RMSE), which measures the average mismatch between each data point and the model. This is why you should look at the RMSE values as your first tool to inspect the quality of the fit — high RMSE values can indicate problems. When two-stage modeling, use the RMSE Explorer to quickly investigate the local models with highest RMSE.

The smaller the RMSE, the closer our model follows the data; if a model goes through each data point exactly, then the RMSE is zero. The illustration shows how increasing the number of parameters in the model can result in overfitting. The 9 data points (shown as black circles) are generated from a cubic polynomial which contains 4 parameters (the “truth”, shown as the black curve) by adding a known amount of noise. We can see that by selecting candidate models containing more parameters than the truth, we can reduce, and even eliminate, any mismatch between the data points and our model, causing the RMSE to vanish. This latter case occurs when the number of parameters in the model is the same as the number of data points (an 8th order polynomial has 9 parameters).

This does not mean that we have obtained a good fit - the model is overfitting, as we can see from the large difference between the model and the truth in

the regions between the data points. By forcing our model to go through all the data points, we have included too much structure in the curve, which reduces the quality of the fit away from the data points.

Similarly, if we use a model with fewer parameters than in the truth, we risk underfitting; our model is not flexible enough to match the truth well. This is shown in the following illustration.

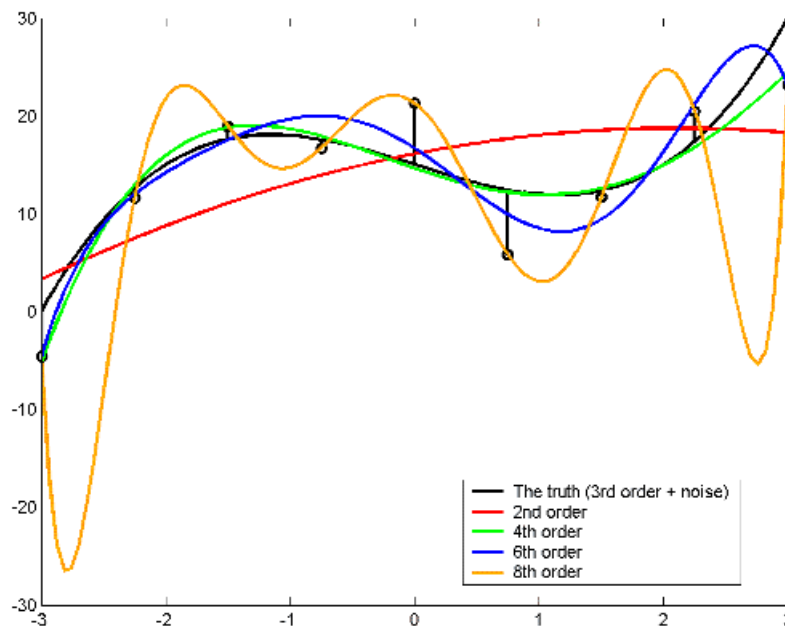

Other Statistics

As illustrated above, relying solely on RMSE can result in overfitting, which leads to poor model performance away from regions containing data points. In general, this problem is tackled by replacing RMSE with some other statistic, which also must be reduced to improve the fit, but which is designed to rise when we start overfitting. This is why you should consider RMSE *and* another tool such as the PRESS statistic to help you decide on the best model.

PRESS RMSE (Predicted sum of squares) is calculated in a similar way to RMSE, except we remove a data point from the fit, and ask the model to predict where that point lies with no knowledge of the data in that area. To calculate PRESS RMSE, this process is repeated for each point in the data set and the results are averaged. If the value of PRESS RMSE is much bigger than the RMSE then we are overfitting. Weighted PRESS and GCV are also derived from this idea.

A different approach to solving the problem of overfitting results in statistics known as “Information Criteria”, such as AIC and BIC. Here, we combine a term involving RMSE with a term that rises with the number of parameters in the model. This explicitly penalizes a model for an increase in its level of structure. Try to minimize the information criteria statistics. Both AIC and BIC are approximations, which get more accurate as the number of observations increases. In general, we do not recommend using them unless the ratio of the numbers of observations to parameters is greater than 40:1 (see Section 2.4 of Burnham and Anderson, “References” on page 6-74). AICc, however, can be used with smaller samples and is the most appropriate information criterion for most problems in engine calibration.

The absolute value of AICc for a given model includes an arbitrary constant, and so is of no direct use. However, the difference between the AICc value for two models is meaningful: one rule of thumb says that if this difference is greater than about 10, then the worse model can be neglected in the selection process (see Section 2.6 of Burnham and Anderson, “References” on page 6-74).

Validation

All of the statistics mentioned above attempt to yield a model which makes good predictions both at the data points, and in the regions in between the data points. The simplest way to confirm that this is the case, is to collect additional data and test (or “validate”) the model against this new data, by evaluating the new RMSE based on these data. Comparing a validation RMSE with the RMSE based on the modeling data is a good model selection statistic. You can use the Model Evaluation window to validate models against other data, and you can use validation data throughout a test plan. See “Using Validation Data” on page 6-84.

How much validation data to collect (or whether it is feasible to collect any at all) are matters governed primarily by practical considerations.

Trends

Throughout this discussion, we have focussed on using statistics for model selection. It is advisable, however, to combine a study of the model statistics with a careful examination of the trends present in the models. It would be a mistake to underestimate the importance of using engineering knowledge as a tool for comparing models. In addition, if two or more models of a different type (e.g. two different RBF kernel functions) follow the same trend, then that lends confidence to those models, because they are likely to be picking up real structure in the data. You can use the cross-section view in the Model Selection window to plot multiple models on the same axes to aid this process.

Where to Find Statistics for Comparing Models

- Look for RMSE and PRESS RMSE values in the model lists at the bottom of the Model Selection window and the Model Browser local, global and response views. Use these to compare models.
- Use the RMSE Explorer for local models; look for tests with high RMSE and investigate. Select **View > RMSE Plots**, or use the toolbar button. See “Using the RMSE Explorer with Local Models” on page 6-12.
- Check for high values of **Cond(J)** (e.g., $> 10^8$). High values of this condition indicator can be a sign of numerical instability. For local models, find **Cond(J)** in the Local diagnostics (select from the list in the **Diagnostic Statistics** pane). To use this for global models, add it using the Summary Statistics dialog box, see below.
- To use other statistics such as information criteria (e.g. AICc) to compare models, you can specify extra statistics at the test plan and global levels. From any global model node select **Model > Summary Statistics**, and use the check boxes to select additional statistics to display. The choices you make in the Summary Statistics dialog box determine what summary statistics are displayed in the global model views and the Model Selection window. These choices also determine what criteria you can use for automatically selecting best models in the Local Model Setup dialog box for Multiple Models, and the Build Models dialog box. Note, you must select the summary statistics before creating the child models to compare. See “Summary Statistics” on page 6-69.

- Use the Model Evaluation window for validating against other data and you will see a Fit RMSE reported alongside the validation RMSE for comparison.

Summary Statistics

Use the Summary Statistics dialog box to choose which statistics you want displayed to help you evaluate models in these tools:

- Local and global views
- Model Selection window
- Criteria for automatically selecting best models in the Build Models dialog box, and the Local Model Setup dialog box for Multiple Models.

The standard summary statistics are PRESS RMSE (for linear models only) and RMSE, and these are always displayed. You can choose additional statistics in Summary Statistics dialog box by selecting the check boxes.

1 To open the Summary Statistics dialog box,

- From any global model node, select **Model > Summary Statistics**.
- From the test plan, right-click on the global model block and select **Summary Statistics** (or use the **Test Plan** menu after selecting the global model block). Use this option *before* building models if you want the summary statistics to apply to all the models within the test plan. Summary statistics are inherited from the test plan node or the parent node on creation of a child node.

2 Choose additional statistics by selecting the check boxes.

3 Click **OK**. Changes made from a global model node are applied immediately to the Summary table and the Models list pane (if there are child nodes to compare). Resetting a model to the default test plan model also resets the summary statistics.

Available summary statistics are:

- GCV, Weighted PRESS, -2LogL , AIC, AICc (small sample), BIC, R^2 , R^2_{adj} , PRESS R^2 , DW, and $\text{cond}(J)$ — full names and formulae are given in the dialog box, as shown following.

- **Cond(J)** is a condition indicator. High values of this (e.g., $> 10^8$) can be a sign of numerical instability. **Cond(J)** is displayed by default for local models in the **Local diagnostics**. To add this for use with global models and elsewhere, select the check box on the Summary Statistics dialog box.
- The three Information Criteria (AIC, AICc (small sample) and BIC) are only available for comparison if exactly the same data is used for all models (same outliers, same y transform). The values of these will still appear for individual model display, but will disappear from the models list for comparison if, for example, you used a different Box-Cox transform.
 - The differences between two Information Criteria are of interest, not the absolute value. As a rule of thumb a difference of 2 or less means models are roughly the same quality of fit.
 - All the Information Criteria impose a penalty for overfitting, which increases linearly (approximately linearly for AICc) with the number of parameters in the model.
 - As a rough guide, typical models favoured by BIC are less complicated than those chosen by AIC or AICc.
 - AICc (small sample) is designed for cases where parameters/observations < 40 . Use AIC or AICc but not both.

See “Model Selection Guide” on page 6-64 for some guidelines and “Using Information Criteria to Compare Models” on page 6-71 for more statistical background.
- The Durbin-Watson statistic measures the correlation of adjacent observations, usually the residuals of a time series regression. A value of 2.0 for the Durbin-Watson statistic suggests that there is no time correlation. e_i is the residual at time i .

For definitions of any of the terms in the Summary Statistics formulae, see “Toolbox Terms and Statistics Definitions” on page 6-114. Note that for ordinary least squares cases, ‘p’ is the number of parameters, but for non-ordinary least squares cases (rols and ridge least squares) ‘p’ is the effective number of parameters ($p = N - df$).

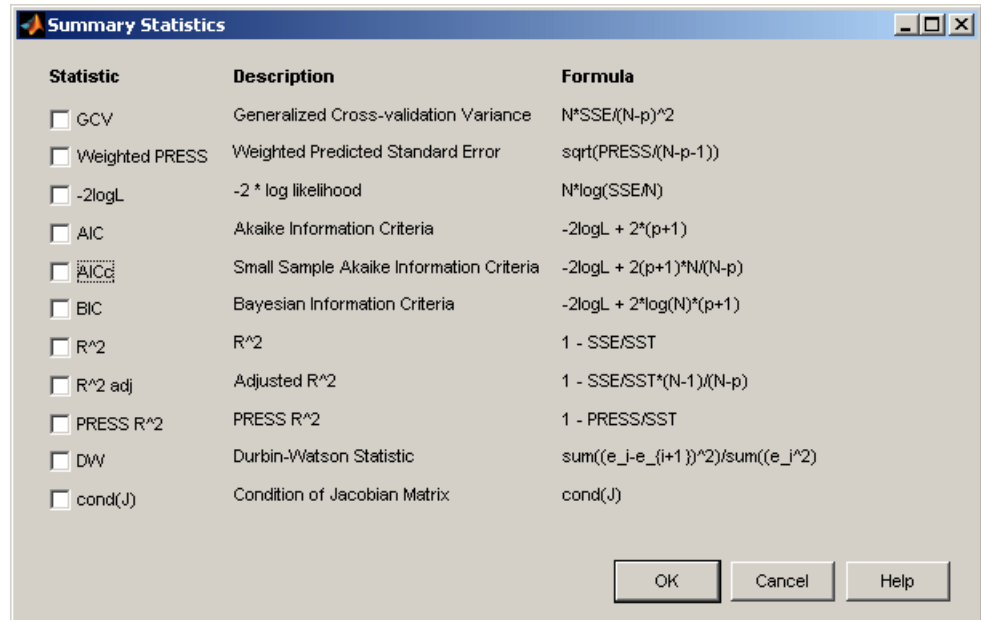

Using Information Criteria to Compare Models

There are information criteria available as additional summary statistics for comparison of models. See “Summary Statistics” on page 6-69 for information on how to display these. This section provides some statistical background to help you compare the Akaike Information Criteria (AIC and AICc) and the Bayes Information Criterion (BIC). See also “Model Selection Guide” on page 6-64 for practical guidelines on using AIC and BIC.

AIC-type criteria are based on the difference in Kullback-Leibler information between two models, or their K-L distance. K-L distance is an appealing measure because it essentially compares the information content of two curves, by calculating the entropy in each. Akaike and others found ways to estimate K-L distance based on the results of a maximum likelihood estimate of the parameters of a model, given some data. These estimates are the information criteria, and become more accurate as the sample size increases.

BIC is derived from Bayes’ theorem, and essentially just applies the Occam effect to select a preferred model; the idea that if two models provide an

equally good fit with some data then the simpler model is the likelier. This can be understood in the following sense: for models with greater complexity (both in terms of the number of parameters and the set of values those parameters can take) it is less remarkable that they are able to fit a given data set well. Conversely, for a simple model, if you happen to encounter a data set for which the model provides an acceptable fit, it would seem a lucky coincidence. Therefore, for data matching both models well, the odds are that the simpler one is closer to the truth.

Quantifying these ideas leads to Bayes factors (evidence ratios) which measure the relative probabilities of two models. In the context of MBC, BIC is an estimate of Bayes factors based on the results of a maximum likelihood estimate, and, like AIC, increases in accuracy in the limit of large sample size. Although priors often spring to mind in the context of Bayes theorem, all of the above can proceed with uniform priors on everything, and the Occam effect still applies.

There is a degree of controversy over which approach gives the best results. Copious literature exists on the subject of Bayesian model selection, a smaller amount on K-L distance based techniques and a still smaller amount comparing the two approaches. Bayesian authors consistently find that BIC performs better in Monte Carlo simulations (e.g. Leonard and Hsu 1999) whereas Burnham and Anderson 2002 (the main proponents of K-L distance techniques) reach conclusions which favour AIC.

Such tests can be set up to favour either criterion, and there are two main effects relevant to understanding this. Differences arise due to the assumptions made about the truth in each case (relevant to choosing Bayes factors or K-L distance), and due to the number of samples relative to the number of parameters in the candidate models.

Regarding the former effect: Bayes factors always seek the simplest model consistent with the data. K-L distance also has this tendency, although not as strongly as the Bayesian approach. As a result, the simulations in which BIC does well tend to be based on simple models with few parameters (Leonard and Hsu choose a simple quadratic, then consider polynomials of order 1 to 7 in their candidate set). Although both approaches choose the correct model more often than any other, AIC gives slightly more weight to the higher order models than does BIC. For this reason, Bayesians often accuse AIC of overfitting.

Burnham and Anderson, however, are biologists and as such they abandon all hope of actually finding the true model in their candidate set - they simply attempt to find the best approximation to the truth. A typical simulation of theirs considers linear models with up to 13 possible variables in the context of predicting body fat. They are not concerned with the subtle shape of curves, only with which variables they can safely throw away. In this scenario, they find that BIC favours too simple a model and hence underfits the data.

Although for BIC most authors assume that the true model is contained within the candidate set, this is not necessary for model comparison — it just concerns the normalisation of the probabilities, and hence not the ratios that form the Bayes factors.

AIC and BIC both improve as estimators of their respective statistical measures as the sample size increases, with relative errors of $O(n^{-1})$, where n is the sample size. AIC is obtained from a first order Taylor expansion, and AICc is a second order correction to that for the special case of Gaussian Likelihood (there is no general second order correction) and should be used when the ratio of data samples to model parameters (in the largest model for nested sets) is less than about 40:1. For very small sample sizes, even Bayesian authors do not seem to trust BIC, but do consider AICc.

In terms of the complexity of the truth, most problems in MBC probably lie in between the two extremes described above: internal combustion engines are not so simple that we assume that our model set really contains the precise, closed-form solutions to the relevant dynamical equations, but we are dealing with a mechanical system, not trying to predict, for example, characteristics of the human body. In terms of the number of samples per model parameter, AIC is seldom likely to be a reliable statistic; AICc should be used instead. But if you have reason to prefer a more conservative estimate of the complexity of the model, BIC should be considered.

For a discussion of Bayes factors, see:

Kass and Raftery (1995). Bayes factors. *Journal of the American Statistical Association* 90, 773-795

See also Chapter 28 from the following book: *Information Theory, Inference, and Learning Algorithms*, available from

- <http://www.inference.phy.cam.ac.uk/mackay/itila/book.html>
- Bayesian Methods, Leonard and Hsu, Cambridge University Press 1999
- Model Selection and Multimodel Inference, Burnham and Anderson, Second Edition, Springer-Verlag 2002.

References

- Classical Regression: Draper and Smith, Applied Regression Analysis (3rd edition), John Wiley & Sons 1998
- BIC Methods: Kass and Raftery, Bayes factors. *Journal of the American Statistical Association*, 90(1995):773-795.
- AIC Methods: Burnham and Anderson, Model Selection and Multimodel Inference: A Practical Information-Theoretic Approach (2nd edition), Springer-Verlag 2002.

Calculate and Compare MLE

In this section...

“Calculating MLE” on page 6-75

“MLE Settings” on page 6-77

Calculating MLE

For an ordinary (univariate) two-stage model, the global models are created in isolation without accounting for any correlations between the response features.

- Using MLE (maximum likelihood estimation) to fit the two-stage model takes account of possible correlations between response features.
- In cases where such correlations occur, using MLE significantly improves the two-stage model.

When you close the Model Selection window, a dialog box asks if you want to calculate MLE. If you click **Cancel** at this point, you can calculate MLE later as follows:

- 1 From the local node, click the MLE icon in the toolbar .

Alternatively, choose **Model > Calculate MLE**.

- 2 The MLE dialog box appears. Click **Start**.

You can alter various MLE settings on this dialog box.

- 3 After you click **Start** a series of progress messages appears, and when finished a new Two-Stage RMSE (root mean square error) value is reported.
- 4 You can perform more iterations by clicking **Start** again to see how the RMSE value changes, or you can click **Stop** at any time.
- 5 Clicking **OK** returns you to the Model Browser, where you can view the new MLE model fit.

Note After calculating MLE, you will notice that the plots and the icons in the model tree for the whole two-stage model (response node, local node, and all response feature nodes) have turned purple. See “Icons: Blue Backgrounds and Purple Worlds” on page 2-29.

You can select all response features in turn to inspect their properties graphically; the plots are all purple to symbolize MLE. At the local node the plots show the purple MLE curves against the black local fit and the blue data.

- From the response feature nodes, at any time, click the **MLE** toolbar icon to recalculate MLE and perform more iterations.
- From the local node, you can click **Select** to enter the Model Selection window, compare the MLE model with the previous univariate model (without correlations), and choose the best. Here you can select the univariate model and click **Assign Best** to “undo” MLE and return to the previous model.

Note If there are exactly enough response features for the model, you can go straight to MLE calculation after model setup without going through the Select process. The MLE toolbar button and the **Model > Calculate MLE** menu item are both active in this case. If you add new response features, you cannot create MLE until you go through model selection to choose the response features to use.

MLE Settings

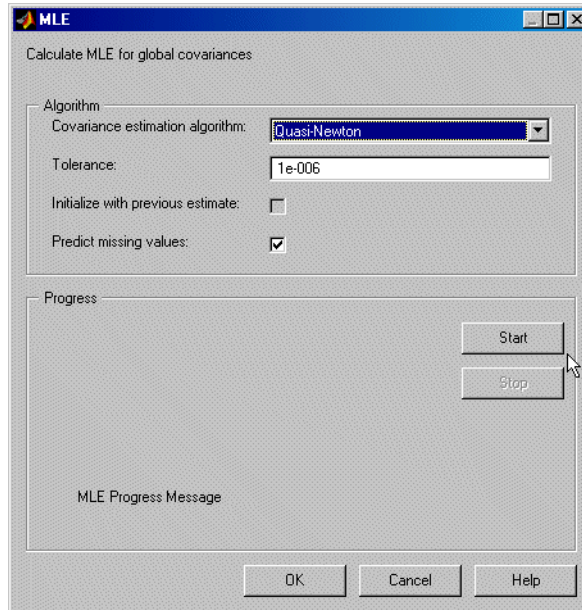

Algorithm

The algorithm drop-down menu offers a choice between two covariance estimation algorithms, Quasi-Newton and Expectation Maximization. These are algorithms for estimating the covariance matrix for the global models.

Quasi-Newton is recommended for smaller problems (< 5 response features and < 100 tests). Quasi-Newton usually produces better answers (smaller values of $-\log L$) and hence is the default for small problems.

Expectation Maximization is an iterative method for calculating the global covariance (as described in Davidian and Giltinan (1995); see References in “Two-Stage Models for Engines” on page 6-104). This algorithm has slow convergence, so you might want to use the **Stop** button.

Tolerance

You can edit the tolerance value. Tolerance is used to specify a stopping condition for the algorithm. The default values are usually appropriate, and if calculation is taking too long you can always click **Stop**.

Initialize with previous estimate

When you recalculate MLE (that is, perform more iterations), there is a check box you can use to initialize with the previous estimate.

Predict missing values

The other check box (selected by default) predicts missing values. When it is selected, response features that are outliers for the univariate global model are replaced by the predicted value. This allows tests to be used for MLE even if one of the response features is missing. If all the response features for a particular test are missing or the check box is unselected, the whole test is removed from MLE calculation.

Examine Two-Stage Response Model

Note The response node remains empty until you have used the Model Selection window at the local level. Exiting this window then copies the best two-stage model to the response node.

Selecting a response model node (with a two-stage icon  — a house *and* a globe) in the model tree produces this view.

Note that local model nodes also have the same icon *after* calculation of the two-stage model (see the model tree for clarification) but selecting them produces the local level view instead.

These plots show the data and the two-stage model fit. You can scroll through the tests using the test controls, as at the local level: by clicking the up/down page number buttons, typing directly in the edit box, or clicking **Select Test** to go directly to a particular test.

6 Selecting Models

The screenshot shows the Model Browser interface for a file named 'Holiday2.mat'. The 'All Models' tree on the left lists several models under 'Two-Stage1', 'Two-Stage', 'Two-Stage(1)', and 'Two-Stage(2)'. The 'Response Model: tq' is selected, and its diagnostic plots are displayed. The plots show 'tq [ft lbf]' versus 'spark (S) [deg]' for four different tests (537, 586, 587, and 588). The 'Local Models' table at the bottom provides summary statistics for the child models PS22, PS32, and POLY2.

Local Models	Local RMSE	Two-Stage RMSE	Two-Stage T ²	-log L
PS22	0.23463	0.80481	3.7486	-560.2946
PS32	0.26756			
POLY2	0.5			

At the bottom of the interface, a status bar indicates: 'Holiday2/Two-Stage1/tq/PS22' is the best model for tq.

The Local Models list view shows all child models and summary statistics for comparison of child models. See “Pooled Statistics” on page 6-10 for information on the diagnostic statistics in the list (such as log likelihood and T^2). The statistics in this list can be seen in the Pooled Statistics table at the local model level.

Response Level: Toolbar and Menus

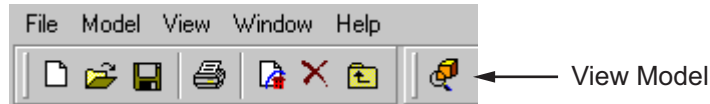

- View Model is the only toolbar icon after the standard project and node management and print buttons (see “Use Project Tools” on page 2-7 for details on these buttons). View Model opens the Model Definition dialog box displaying the model terms. See “Model Definition Dialog Box” on page 6-39.
- **File**, **Window**, and **Help** menus remain constant throughout the Model Browser. See “Use Project Menus” on page 2-8.
- **Model > Evaluate** — Select from the submenu **Fit Data** (also **Ctrl+E**), **Validation Data**, **No Data**, or **Other Data**. Opens the Model Evaluation window displaying the fit relative to the selected data (or no data). You must attach validation data to the test plan before you can use it. If you select **Other Data** a wizard appears to select the data. See “Using Validation Data” on page 6-84.
- **Model > Select** is the same as the **Select** button in the **Local Models** pane and opens the Model Selection window. In this window, you can examine the fit of the two-stage model against the local fit and the data.
- **View > View Model Definition** duplicates the toolbar button and opens the Model Definition dialog box. See “Model Definition Dialog Box” on page 6-39.

Evaluate Model Fit

In this section...
“About the Model Evaluation Window” on page 6-82
“Using Validation Data” on page 6-84

About the Model Evaluation Window

The Model Evaluation Window is intended to help you evaluate the fit of your model. You can evaluate against the fit data, validation data, other data, or without reference to any data. The window displays some of the same views you see in the “Plots and Statistics for Comparing Models” on page 6-44. The views available depend on what kind of model you are evaluating and the evaluation mode you choose.

You can access the Model Evaluation window via the menu items under **Model > Evaluate** from any of the modeling nodes: the one-stage or two-stage model node, local model node, response feature nodes, or any child model nodes. You can use validation data with any model except response features.

The Model Selection window allows you to compare different models with each other and with the data used to create these models. The Model Evaluation window also allows you either to examine a model without data or to validate it against data other than that used in creating the model. For any model node, model evaluation is a quick way to examine the model in more ways than those available in the main Browser views. For example, local models with more than one input factor can only be viewed in the Predicted/Observed view in the main Browser, and the Model Selection window only shows you the two-stage model, so you go to Model Evaluation to view the local model itself in more detail. For other models, such as childless response feature nodes or their child nodes, **Select** is not available, so Model Evaluation is the only way to view these models in detail.

There are four modes for evaluation, determined by your selection from the **Model > Evaluate** submenu :

- **Fit data** (or the hot key **Ctrl+E**) — The evaluation window appears, and the data shown along with the model surface is the data that was used to create this model. “Summary Statistics” on page 6-69 are shown in the model list. The views available are
 - Residuals
 - Response surface
 - Cross section
 - Tests — Two-stage models only
 - Predicted/observed — One-stage or response feature only
- **Validation data** — The evaluation window appears (titled Model Validation). You can compare the model with the validation data. This option is only available if you have attached validation data to the test plan. See “Using Validation Data” on page 6-84. You can only use validation data with two-stage (response), local, and one-stage models (not response features). The views available are
 - Residuals
 - Response surface
 - Cross section
 - Tests — two-stage models only. The local fit is not shown, as the local model was fitted to different data. Validation RMSE appears in the model list for comparison with the Fit RMSE.
- **No data** — The evaluation window appears with only the model surface view and the cross-section view. These do not show the model fit against data. You can investigate the shape of the model surface.
- **Other data** — Opens the Select Data for Evaluation wizard, where you can choose the data that is shown along with the model views. The steps are the same as selecting validation data to the test plan. Select a data set, match signals if necessary (only if signal names do not match), and select tests you want to use (the default includes all tests). See “Using Validation Data” on page 6-84. When you click **Finish**, the evaluation window then appears with the same views shown for validation data.

For more information about each view, see “Plots and Statistics for Comparing Models” on page 6-44.

Using Validation Data

You can attach validation data to your test plan, then use it to validate your models. Validation RMSE appears in the statistics tables, you can view plots of validation residuals, and you can open the Model Evaluation window to investigate your models with validation data.

To attach a data set to your test plan for validation:

- 1 At the test plan level, select **TestPlan > Validation Data**. The Select Data for Validation wizard appears.

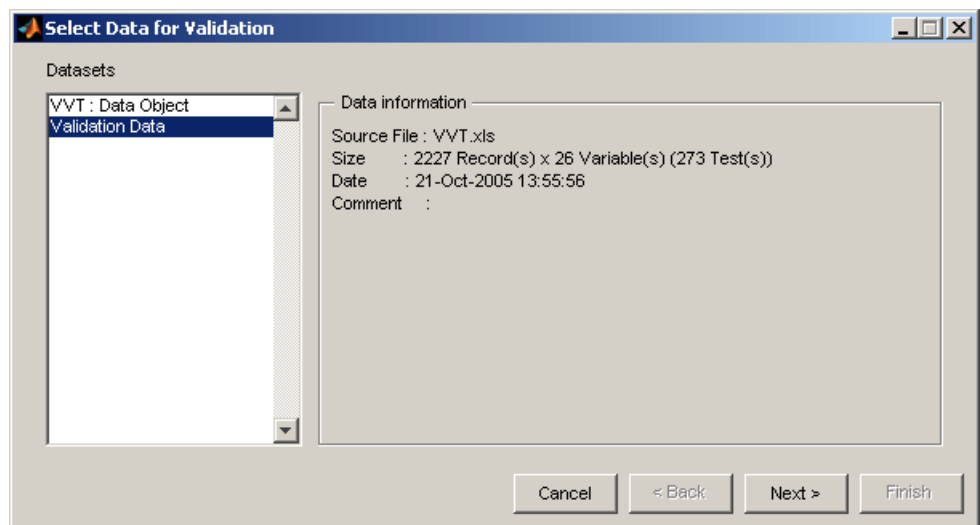

- 2 Select a data set, and click **Next**.
- 3 If the input factors and responses required to evaluate the model do not appear in the selected data set, the next screen allows you to match signal names in the selected data set to those in the model. If signal names match you next see the screen to select tests.

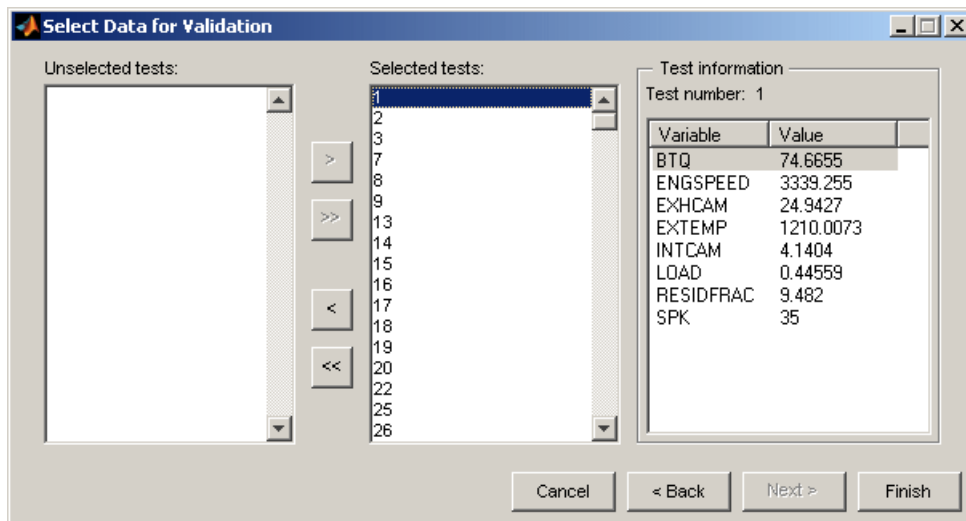

Choose the tests from this data set to use. By default all tests are selected. For the currently selected test, the mean test values of all variables in this data set are displayed on the right.

4 Click **Finish** to use the selected tests to validate models in this test plan.

The validation data set appears in the Data Set information pane for the test plan. Validation RMSE is automatically added to the summary statistics for comparison in the bottom list view of response models in the test plan.

You can now use the validation data to validate all models except response features. You can see validation statistics in the following places:

- **Model List** — **Validation RMSE** appears in the summary statistics in the lower list of models at the test plan, response and one-stage nodes
- **At the local node view:**
 - **Pooled Statistics** — **Validation RMSE** — The root mean squared error between the two-stage model and the validation data for all tests
 - **Diagnostic Statistics > Local Diagnostics** — **Local model Validation RMSE** for the currently selected test (if validation data is available for the current test—global variables must match)

- Diagnostic Statistics > Summary Table — Validation RMSE for the current test (if available) appears for local multiple models
- Summary Table — Validation RMSE for one-stage models

You can view validation plots in the following places:

- Plots of Validation residuals — For local and one-stage models in the Model Browser
- From any model node except response features, you can select **Model > Evaluate > Validation Data** to open the Model Evaluation window and investigate the model with the selected validation data.
- Similarly you can use the Model Evaluation window to investigate your models with other data, by using the **Model > Evaluate > Other Data** menu choice from a modeling node. The steps required are the same: select a data set, match signal names if necessary, and select tests to use.

For information about the available views, see “Evaluate Model Fit” on page 6-82.

Stepwise Regression

In this section...

“What Is Stepwise?” on page 6-87

“Automatic Stepwise” on page 6-87

“Using the Stepwise Regression Window” on page 6-88

“Stepwise in the Model Building Process” on page 6-94

“PRESS statistic” on page 6-97

What Is Stepwise?

Use the Stepwise functions to help you search for a good model fit. The goal of the stepwise search is to minimize PRESS. Minimizing Predicted Error Sum of Squares (PRESS) is a good method for working toward a regression model that provides good predictive capability over the experimental factor space. See “PRESS statistic” on page 6-97.

The use of PRESS is a key indicator of the predictive quality of a model. The predicted error uses predictions calculated without using the observed value for that observation. PRESS is known as **Delete-1** statistics in the Statistics Toolbox product. See also “Two-Stage Models for Engines” on page 6-104.

You can choose automatic stepwise during model setup, or manual control using the Stepwise window.

- Use the **Stepwise** menu in the Model Setup dialog boxes to run stepwise automatically when building linear models.
- Open the stepwise regression window through the  toolbar icon when you are in the global level view (that is, with a response feature selected in the “Navigate the Model Tree” on page 2-26). The Stepwise tool provides a number of methods of selecting the model terms that should be included.

Automatic Stepwise

You can set the Minimize PRESS, Forward, and Backward selection routines to run automatically without the need to enter the stepwise figure.

You can set these options in the Model Setup dialog box, when you initially set up your test plan, or from the global level as follows:

- 1 Select **Model > Set Up**.
- 2 The Global Model Setup dialog box has a drop-down menu **Stepwise**, with the options **None**, **Minimize PRESS**, **Forward selection**, and **Backward selection**.

Using the Stepwise Regression Window

- 1 Use the stepwise command buttons at the bottom of the window (also available in the **Regression** menu) as follows:
 - Click **Min. PRESS** (labelled 1 in the following figure) to automatically include or remove terms to minimize PRESS. This procedure provides a model with improved predictive capability.
 - **Include All** terms in the model (except the terms flagged with **Status** as **Never**). This option is useful in conjunction with **Min. PRESS** and backward selection. For example, first click **Include All**, then **Min. PRESS**. Then you can click **Include All** again, then **Backwards**, to compare which gives the best result.
 - **Remove All** terms in the model (except the terms flagged with **Status** as **Always**). This option is useful in conjunction with forward selection (click **Remove All**, then **Forwards**).
 - **Forwards** selection adds all terms to the model that would result in statistically significant terms at the $\alpha\%$ level (see Step 4 for alpha). The addition of terms is repeated until all the terms in the model are statistically significant.

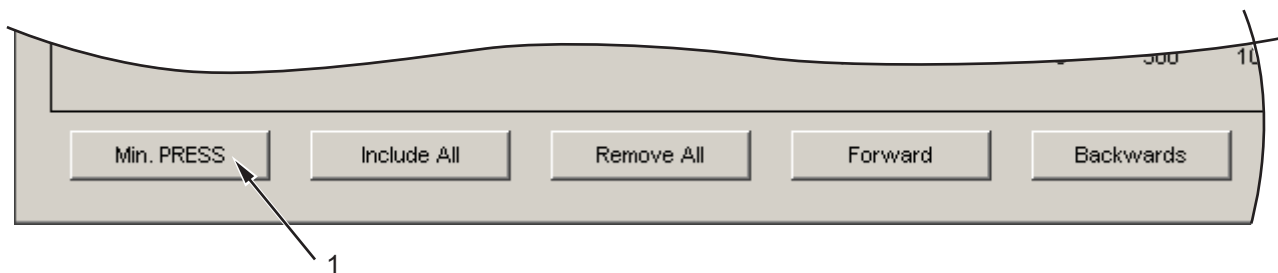

- **Backwards** selection removes all terms from the model that are not statistically significant at the $\alpha\%$ level. The removal of terms is repeated until all the terms in the model are statistically significant.
- 2** Terms can be also be manually included or removed from the model by clicking on the Term, Next PRESS, or coefficient error bar line (labelled 2 in the following figure).

The confidence intervals for all the coefficients are shown to the right of the table. Note that the interval for the constant term is not displayed, as the value of this coefficient is often significantly larger than other coefficients.

Terms that are currently not included in the model are displayed in red. See Stepwise Table on page 6-93 for the meaning of the column headings.

6 Selecting Models

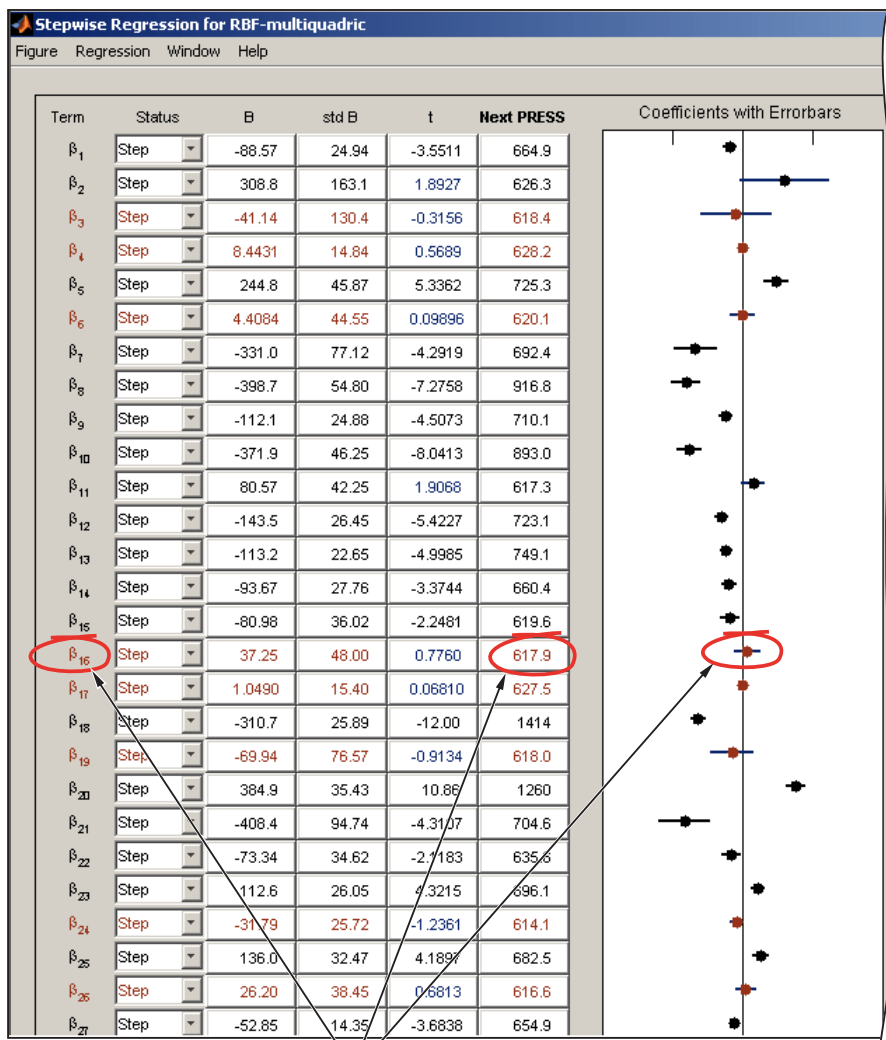

3 A history of the PRESS and summary statistics is shown on the right of the stepwise figure. You can return to a previous model by clicking an item in the list box or a point on the Stepwise PRESS History plot (labelled 3 in the following figure).

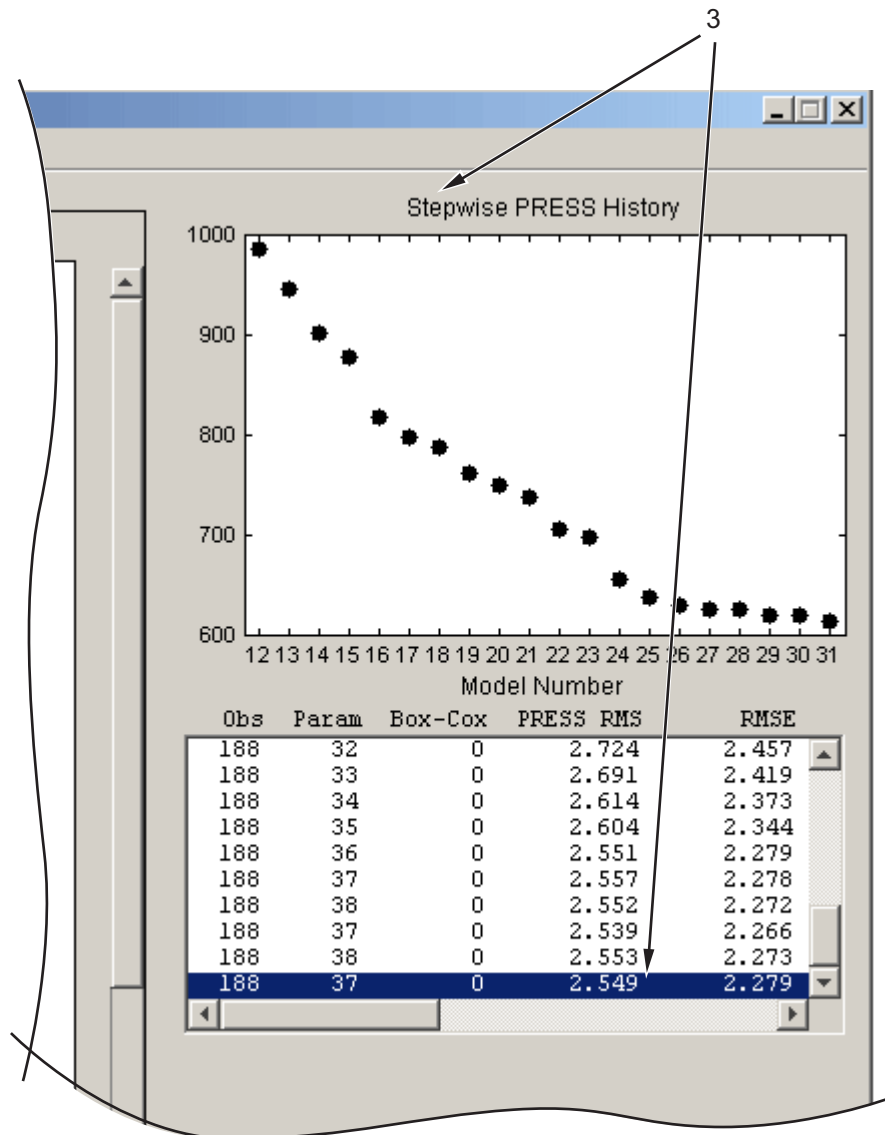

- 4 The critical values for testing whether a coefficient is statistically different from zero at the $\alpha\%$ level are displayed at the bottom right side of the stepwise figure. You can enter the value of α in the edit box (labelled 4 in

the following figure) to the left of the critical values. The default is 5%. The ANOVA Table on page 6-31 is shown for the current model .

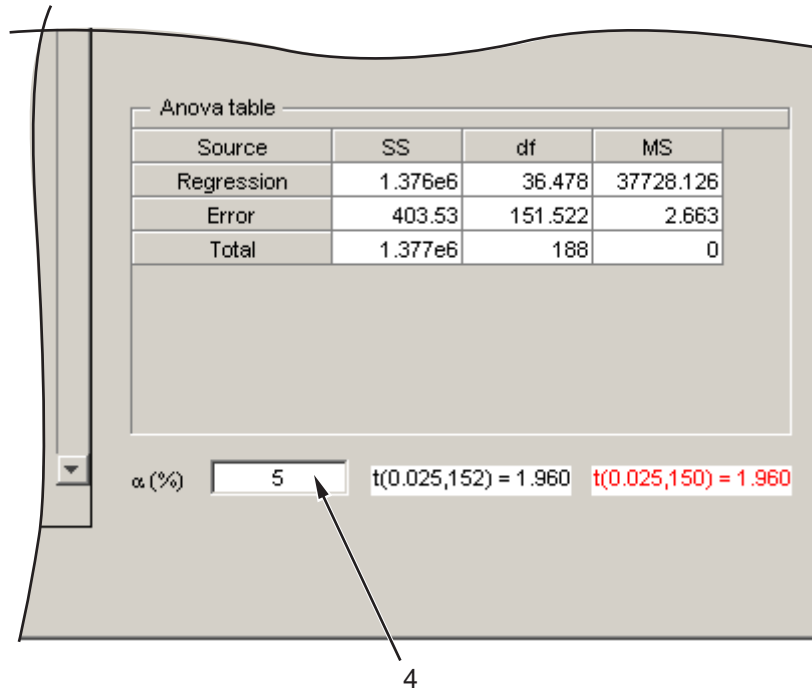

Any changes made in the stepwise figure automatically update the diagnostic plots in the Model Browser.

You can revert to the starting model when closing the Stepwise window. When you exit the Stepwise window, the Confirm Stepwise Exit dialog box asks Do you want to update regression results? You can click **Yes** (the default), **No** (to revert to the starting model), or **Cancel** (to return to the Stepwise window).

Stepwise Table

Term	Label for Coefficient
Status	<p>Always. Stepwise does not remove this term.</p> <p>Never. Stepwise does not add this term.</p> <p>Step. Stepwise considers this term for addition or removal.</p>
B	Value of coefficient. When the term is not in the model the value of the coefficient if it is added to the model is displayed in red.
stdB	Standard error of coefficient.
t	<i>t</i> value to test whether the coefficient is statistically different from zero. The <i>t</i> value is highlighted in blue if it is less than the critical value specified in the $\alpha\%$ edit box (at bottom right).
Next PRESS	<p>The value of PRESS if the inclusion or exclusion of this term is changed at the next iteration.</p> <p>A yellow highlighted cell indicates the next recommended term to change. Including or excluding the highlighted term (depending on its current state) will lead to the greatest reduction in the PRESS value.</p> <p>If there is no yellow highlighting this means that the PRESS value is already minimized.</p> <p>If there is a yellow cell, the column header is also yellow to alert you that you could make a change to achieve a smaller PRESS value. The column header is highlighted because you may need to scroll to find the yellow cell.</p>

The preceding table describes the meanings of the column headings in the Stepwise Regression window.

Stepwise in the Model Building Process

Once you have set up a model, you should create several alternative models, use the Stepwise functions and examine the diagnostic statistics to search for a good model fit. For each response feature,

- 1** Begin by conducting a stepwise search.

You can do this automatically or by using the Stepwise window.

The goal of the stepwise search is to minimize PRESS. Usually not one but several candidate models per response features arise, each with a very similar PRESS R^2 . The predictive capability of a model with a PRESS R^2 of 0.91 cannot be assumed superior in any meaningful engineering sense to a model with a PRESS R^2 of 0.909. Further, the nature of the model building process is that the “improvement” in PRESS R^2 offered by the last few terms is often very small. Consequently, several candidate models can arise. You can store each of the candidate models and associated diagnostic information separately for subsequent review. Do this by making a selection of child nodes for the response feature.

However, experience has shown that a model with a PRESS R^2 of less than 0.8, say, is of little use as a predictive tool for engine mapping purposes. This criterion must be viewed with caution. Low PRESS R^2 values can result from a poor choice of the original factors but also from the presence of outlying or influential points in the data set. Rather than relying on PRESS R^2 alone, a safer strategy is to study the model diagnostic information to discern the nature of any fundamental issues and then take appropriate corrective action.

- 2** Once the stepwise process is complete, the diagnostic data should be reviewed for each candidate model.

It might be that these data alone are sufficient to provide a means of selecting a single model. This would be the case if one model clearly exhibited more ideal behavior than the others. Remember that the interpretation of diagnostic plots is subjective.

- 3** You should also remove outlying data at this stage. You can set criteria for detecting outlying data. The default criterion is any case where the absolute value of the external studentized residual is greater than 3.

- 4** After removing outlying data, continue the model building process in an attempt to remove further terms.

High-order terms might have been retained in the model in an attempt to follow the outlying data. Even after removing outlying data, there is no guarantee that the diagnostic data will suggest that a suitable candidate model has been found. Under these circumstances,

- 5** A transform of the response feature might prove beneficial.

A useful set of transformations is provided by the Box and Cox family, see “Box-Cox Transformation” on page 6-100. Note that the Box-Cox algorithm is model dependent and as such is always carried out using the $(N \times q)$ regression matrix X .

- 6** After you select a transform, you should repeat the stepwise PRESS search and select a suitable subset of candidate models.
- 7** After this you should analyze the respective diagnostic data for each model.

It might not be apparent why the original stepwise search was carried out in the natural metric. Why not proceed directly to taking a transformation? This seems sensible when it is appreciated that the Box-Cox algorithm often, but not always, suggests that a contractive transform such as the square root or log be applied. There are two main reasons for this:

- The primary reason for selecting response features is that they possess a natural engineering interpretation. It is unlikely that the behavior of a transformed version of a response feature is as intuitively easy to understand.
- Outlying data can strongly influence the type of transformation selected. Applying a transformation to allow the model to fit bad data well does not seem like a prudent strategy. By “bad” data it is assumed that the data is truly abnormal and a reason has been discovered as to why the data is outlying; for example, “The emission analyzer was purging while the results were taken.”

Finally, if you cannot find a suitable candidate model on completion of the stepwise search with the transformed metric, then a serious problem exists either with the data or with the current level of engineering knowledge of the

system. Model augmentation or an alternative experimental or modeling strategy should be applied in these circumstances.

After these steps it is most useful to validate your model against other data (if any is available). See “Evaluate Model Fit” on page 6-82.

See also these guideline pages with links to information about each of the steps involved in creating one and two-stage models and then searching for the best fit:

- “Set Up a One-Stage Model” on page 1-3
- “Set Up a Two-Stage Model” on page 1-5
- “Create Alternative Models to Compare” on page 1-14

The recommended overall stepwise process is best viewed graphically, as shown in the following flow chart.

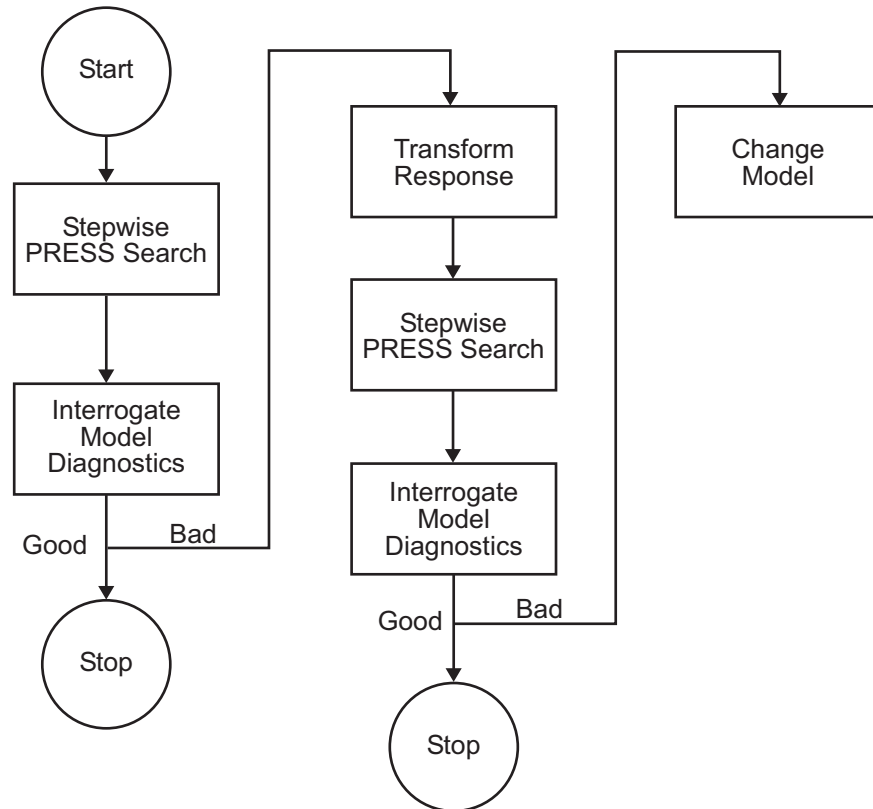

Note that the process depicted in the preceding diagram should be carried out for each member of the set of response features associated with a given response and then repeated for the remaining responses.

PRESS statistic

With n runs in the data set, the model equation is fitted to $n-1$ runs and a prediction taken from this model for the remaining one. The difference between the recorded data value and the value given by the model (at the value of the omitted run) is called a prediction residual. PRESS is the sum of

squares of the prediction residuals. The square root of PRESS/n is PRESS RMSE (root mean square prediction error).

Note that the prediction residual is different from the ordinary residual, which is the difference between the recorded value and the value of the model when fitted to the whole data set.

The PRESS statistic gives a good indication of the predictive power of your model, which is why minimizing PRESS is desirable. It is useful to compare PRESS RMSE with RMSE as this may indicate problems with overfitting. RMSE is minimized when the model gets very close to each data point; 'chasing' the data will therefore improve RMSE. However chasing the data can sometimes lead to strong oscillations in the model between the data points; this behavior can give good values of RMSE but is not representative of the data and will not give reliable prediction values where you do not already have data. The PRESS RMSE statistic guards against this by testing how well the current model would predict each of the points in the data set (in turn) if they were not included in the regression. To get a small PRESS RMSE usually indicates that the model is not overly sensitive to any single data point.

For more information see "Model Selection Guide" on page 6-64, "Stepwise Regression" on page 6-87 and "Toolbox Terms and Statistics Definitions" on page 6-114.

Note that calculating PRESS for the two-stage model applies the same principle (fitting the model to $n-1$ runs and taking a prediction from this model for the remaining one) but in this case the predicted values are first found for response features instead of data points. The predicted value, omitting each test in turn, for each response feature is estimated. The predicted response features are then used to reconstruct the local curve for the test and this curve is used to obtain the two-stage predictions. This is applied as follows:

To calculate two stage PRESS:

- 1 For each test, S , do the following steps:
 - For each of the response features, calculate what the response feature predictions would be for S (with the response features for S removed from the calculation).
 - This gives a local prediction curve C based on all tests except S .

- For each data point in the test, calculate the difference between the observed value and the value predicted by C .

2 Repeat for all tests.

Sum the square of all of the differences found and divide by the total number of data points.

Box-Cox Transformation

You can apply a Box-Cox transform to any one-stage or response feature model node (any models with a global icon) by selecting **Model > Set Up** and entering a number for lambda in the **Box-Cox** edit box.

For linear models (polynomials, polynomial splines, and RBFs) you can also use the Box-Cox Transformation dialog box described in the following section, by using the toolbar button or **Model** menu item **Box-Cox Transform**.

You might want to transform a response feature either to correct for nonnormality and/or a heteroscedastic variance structure. A useful class of transformations for this purpose is the power transform $y^{(\lambda)}$, where λ is a parameter to be determined. Box and Cox (1964) showed how λ and the regression coefficients themselves could be estimated simultaneously using the method of maximum likelihood. The procedure consists of conducting a standard least squares fit using

$$y^{(\lambda)} = \frac{y^\lambda - 1}{\lambda y^{\lambda-1}} \quad \text{for } \lambda \neq 0$$

$$y^{(\lambda)} = y \ln(y) \quad \text{for } \lambda = 0$$

where the so called geometric mean of the observations is given by

$$y = \exp \left[\frac{\sum_{i=1}^N \ln(y_i)}{N} \right]$$

The maximum likelihood estimate of λ corresponds to the value for which the $SSE(\lambda)$ from the fitted model is a minimum. This value of λ is determined by fitting a model (assumed throughout to be defined by the regression matrix for the full model - X) for various levels of λ and choosing the value corresponding to the minimum $SSE(\lambda)$. A plot of $SSE(\lambda)$ versus λ is often used to facilitate this choice.

The parameter λ is swept between the range of -3 to 3 in increments of 0.5.

You can enter a value for lambda in the edit box that approaches the point on the plot with the smallest SSE.

Although $SSE(\lambda)$ is a continuous function of λ , simple choices for λ are recommended. This is because the practical difference between 0.5 and 0.593, say, is likely to be very small but a simple transform like 0.5 is much easier to interpret.

You can also find an approximate $100(1-\alpha)$ confidence interval on l by computing

$$SS^* = SSE(\lambda) \left[1 + \frac{t_{\alpha/2, \nu}}{\nu} \right]$$

where ν is the number of residual degrees of freedom equal to $(N-q)$.

In this formula λ is understood to be the value that minimizes $SSE(\lambda)$. Note that this confidence interval might encompass more than one incremental value for λ . In this case, any of these values is as valid as any other and you can select any of these transformations from which to develop trial models.

- You should always look at the residuals plots at the top to see the effect of different transforms.
- You can create several child nodes of a single model and choose different transforms for each to compare them using the rest of the Model Browser tools.

For the sake of clarity, consider the following example, which illustrates the results of applying the Box-Cox algorithm to a polyspline torque model.

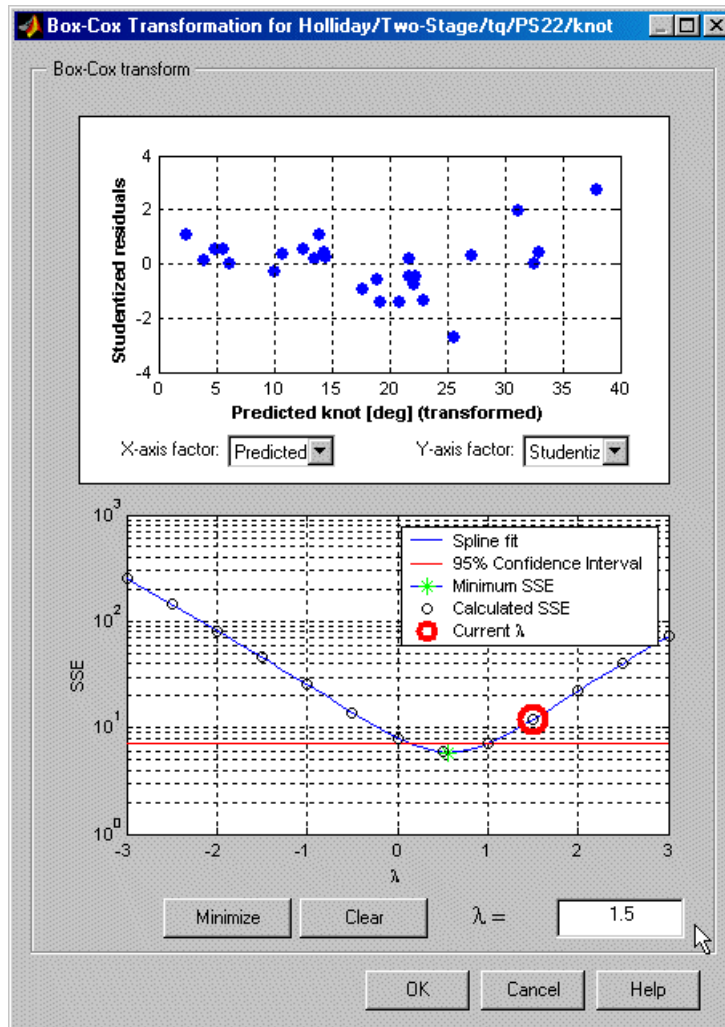

In this example the minimum value of $SSE(\lambda)$ occurs near to $\lambda=0$. The minimum is marked in green. The 95% confidence limit has been calculated and drawn on the figure as a red solid line. It is apparent in this example that, after rounding to the nearest incremental value contained within the

confidence interval, any λ in the range $0 \leq \lambda \leq 1$ is appropriate. Of the three possible increments, 0, 0.5, and 1, $\lambda = 0.5$ is the closest to the minimum SSE.

You can select any point on the plot by clicking. The chosen point (current lambda) is then outlined in red. You can also enter values of lambda directly in the edit box and press **Enter**.

Two-Stage Models for Engines

In this section...

“Overview of the Mathematics of Two-Stage Models” on page 6-104

“Local Models” on page 6-106

“Local Covariance Modeling” on page 6-106

“Response Features” on page 6-108

“Global Models” on page 6-108

“Two-Stage Models” on page 6-109

“Global Model Selection” on page 6-110

“Initial Values for Covariances” on page 6-111

“Quasi-Newton Algorithm” on page 6-111

“Expectation Maximization Algorithm” on page 6-111

“References” on page 6-112

“Linear Regression” on page 6-113

“Toolbox Terms and Statistics Definitions” on page 6-114

Overview of the Mathematics of Two-Stage Models

This section contains an overview of the mathematics of two-stage models. A comprehensive reference for two-stage modeling is Davidian and Giltinan [3]. The information is divided into the following sections:

Lindstrom and Bates [6] define repeated measurements as data generated by observing a number of individuals repeatedly under various experimental conditions, where the individuals are assumed to constitute a random sample from a population of interest. An important class of repeated measurements is longitudinal data where the observations are ordered by time or position in space. More generally, longitudinal data is defined as repeated measurements where the observations on a single individual are not, or cannot be, randomly assigned to the levels of a treatment of interest.

Modeling data of this kind usually involves the characterization of the relationship between the measured response, y , and the repeated measurement factor, or covariate x . Frequently, the underlying systematic relationship between y and x is nonlinear. In some cases the relevant nonlinear model can be derived on physical or mechanistic grounds. However, in other contexts a nonlinear relationship might be imposed simply to provide a convenient empirical description for the data. The presence of repeated observations on an individual requires particular care in characterizing the variation in the experimental data. In particular, it is important to represent two sources of variation explicitly: random variation among measurements within a given individual (*intraindividual*) and random variation among individuals (*interindividual*). Inferential procedures accommodate these different variance components within the framework of an appropriate hierarchical statistical model. This is the fundamental idea behind the analysis of repeated measurement data.

Holliday [1,2] was perhaps the first to apply nonlinear repeated measurements analysis procedures to spark ignition engine data. The focus of Holliday's work was the modeling of data taken from engine mapping experiments. In these experiments, engine speed, load, and air/fuel ratio were held constant while spark was varied. Various engine response characteristics, for example, torque or emission quantities, were measured at each spark setting. Holliday modeled the response characteristics for each sweep as a function of spark advance. Variations in the individual sweep parameters were then modeled as a function of the global engine operating variables speed, load, and air/fuel ratio. Conceptually, variations in the measurements taken within a sweep represent the intraindividual component of variance. Similarly, variation in the sweep-specific parameters between sweeps represents the interindividual component of variance. You can generalize these principles to other steady-state engine modeling exercises where the nature of data collection usually involves sweeping a single engine control variable while the remainder are held at fixed values. These points suggest that nonlinear repeated measurements analysis represents a general approach to the parameterization of mean value engines models for controls-oriented development.

Another application for models of this form is the flow equations for a throttle body. Assuming the flow equations are based upon the usual one-dimensional isentropic flow principle, then they must be modified by an effective area term, A_e , which accounts for the fact that the true flow is multidimensional

and irreversible. You can map the throttle flow characteristics by sweeping the throttle position at fixed engine speed. This data collection methodology naturally imposes a hierarchy the analysis of which is consistent with the application of nonlinear repeated measures. Experience in modeling effective area suggests that free knot spline or biological growth models provide good local predictions. The global phase of the modeling procedure is concerned with predicting the systematic variation in the response features across engine speed. A free knot spline model has proven useful for this purpose.

Local Models

Modeling responses locally within a sweep as a function of the independent variable only. That is,

$$y_i^j = f_i(s_i^j, \theta_i) + \varepsilon_i^j \quad \text{for } j = 1, 2, \dots, m_i \quad (6-1)$$

where the subscript i refers to individual tests and j to data within a test, s_i^j is the j^{th} independent value, θ_i is a ($r \times 1$) parameter vector, y_i^j is the j^{th} response, and ε_i^j is a normally distributed random variable with zero mean and variance σ^2 . Note that equation (4-1) can be either a linear or a nonlinear function of the curve fit parameters. The assumption of independently normally distributed errors implies that the least squares estimates of θ are also maximum likelihood parameters.

Local Covariance Modeling

The local model describes both the systematic and random variation associated with measurements taken during the i^{th} test. Systematic variation is characterized through the function f while variation is characterized via the distributional assumptions made on the vector of random errors e_i . Hence, specification of a model for the distribution of e_i completes the description of the intratest model. The Model-Based Calibration Toolbox product allows a very general specification of the local covariance:

$$e_i \sim N(0, \sigma^2 C_i(\beta_i, \xi_i)) \quad (6-2)$$

where C_i is an ($n_i \times n_i$) covariance matrix, σ^2 is the coefficient of variation, and ξ_i is a (q -by-1) vector of dispersion parameters that account for heterogeneity

of variance and the possibility of serially correlated data. The specification is very general and affords considerable flexibility in terms of specifying a covariance model to adequately describe the random component of the intratest variation.

The Model-Based Calibration Toolbox product supports the following covariance models:

- Power Variance Model:

$$C_i = \text{diag}\left\{f(x_i, \beta_i)^{\xi_1}\right\} \quad (6-3)$$

- Exponential Variance Model:

$$C_i = \text{diag}\{\exp(f(x_i, \beta_i)\xi_1)\} \quad (6-4)$$

- Mixed Variance Model:

$$C_i = \text{diag}\left\{\xi_1 + f(x_i, \theta_i)^{\xi_2}\right\} \quad (6-5)$$

where $\text{diag}\{x\}$ is a diagonal matrix.

Correlation models are only available for equispaced data in the Model-Based Calibration Toolbox product. It is possible to combine correlation models with models with the variance models such as power.

One of the simplest structures that can be used to account for serially correlated errors is the AR(m) model (autoregressive model with lag m). The general form of the AR(m) model is

$$e_j = \phi_1 e_{j-1} + \phi_2 e_{j-2} + \dots + \phi_m e_{j-m} + v_j \quad (6-6)$$

where ϕ_k is the k^{th} lag coefficient and v_j is an exogenous stochastic input identically and independently distributed as $N(0, \sigma_v^2)$. First- and second-order autoregressive models are implemented in the Model-Based Calibration Toolbox product.

Another possibility is a moving average model (MA). The general structure is

$$e_j = \phi_1 v_{j-1} + \phi_2 v_{j-2} + \dots + \phi_m v_{j-m} + v_j \quad (6-7)$$

where ϕ_k is the k^{th} lag coefficient and v_j is an exogenous stochastic input identically and independently distributed as $N(0, \sigma_v^2)$. Only a first-order moving average model is implemented in the Model-Based Calibration Toolbox product.

Response Features

From an engineering perspective, the curve fit parameters do not usually have any intuitive interpretation. Rather characteristic geometric features of the curve are of interest. The terminology “response features” of Crowder and Hand [7] is used to describe these geometric features of interest. In general, the response feature vector p_i for the i^{th} sweep is a nonlinear function (g) of the corresponding curve fit parameter vector θ_i , such that

$$p_i = g(\theta_i) \quad (6-8)$$

Global Models

Modeling the variation in the response features as a function of the global variables. The response features are carried through to the second stage of the modeling procedure rather than the curve fit parameters because they have an engineering interpretation. This ensures that the second stage of the modeling process remains relatively intuitive. It is much more likely that an engineer will have better knowledge of how a response feature such as MBT behaves throughout the engine operating range (at least on a main effects basis) as opposed to an esoteric curve fit parameter estimate.

The global relationship is represented by one of the global models available in the Model-Based Calibration Toolbox product. In this section we only consider linear models that can be represented as

$$P_i = X_i \beta + \gamma_i \text{ for } i=1,2,\dots,r \quad (6-9)$$

where the X_i contains the information about the engine operating conditions at the i^{th} spark sweep, β is the vector of global parameter estimates that must be estimated by the fitting procedure, and γ_i is a vector of normally

distributed random errors. It is necessary to make some assumption about the error distribution for γ , and this is typically a normal distribution with

$$\gamma_i \sim N_r(0, D) \quad (6-10)$$

where r is the number of response features. The dimensions of D are $(r \times r)$ and, being a variance-covariance matrix, D is both symmetric and positive definite. Terms on the leading diagonal of D represent the test-to-test variance associated with the estimate of the individual response features. Off-diagonal terms represent the covariance between pairs of response features. The estimation of these additional covariance terms in a multivariate analysis improves the precision of the parameter estimates.

Two-Stage Models

To unite the two models, it is first necessary to review the distributional assumptions pertaining to the response feature vector p_i . The variance of p_i ($\text{Var}(p_i)$) is given by

$$\text{Var}(p_i) = \left[\frac{\partial g(\theta_i)}{\partial \theta} \right] \sigma^2 C_i \left[\frac{\partial g(\theta_i)}{\partial \theta} \right]^T \quad (6-11)$$

For the sake of simplicity, the notation $\sigma^2 C_i$ is to denote $\text{Var}(p_i)$. Thus, p_{ii} is distributed as

$$p_i \sim N_r(p_i, \sigma^2 C_i) \quad (6-12)$$

where C_i depends on f_i through the variance of θ_i and also on g_i through the conversion of θ_i to the response features p_i . Two standard assumptions are used in determining C_i : the asymptotic approximation for the variance of maximum likelihood estimates and the approximation for the variance of functions of maximum likelihood estimates, which is based on a Taylor series expansion of g_i . In addition, for nonlinear f or g_i , C_i depends on the unknown θ_i ; therefore, we will use the estimate $\hat{\theta}_i$ in its place. These approximations are likely to be good in the case where σ^2 is small or the number of points per sweep (m_i) is large. In either case we assume that these approximations are valid throughout.

We now return to the issue of parameter estimation. Assume that the γ_i are independent of the ε_i^j . Then, allowing for the additive replication error in response features, the response features are distributed as

$$p_i \sim N(X_i, \beta, \sigma^2 C_i + D) \quad (6-13)$$

When all the tests are considered simultaneously, equation (6-13) can be written in the compact form

$$P \sim N(Z\beta, W(\omega)) \quad (6-14)$$

where P is the vector formed by stacking the n vectors p_i on top of each other, Z is the matrix formed by stacking the n X_i matrices, W is the block diagonal weighting matrix with the matrices on the diagonal being $\sigma^2 C_i + D$, and ω is a vector of dispersion parameters. For the multivariate normal distribution (6-14) the negative log likelihood function can be written:

$$\log L(\beta, \omega) = \log |W| + (P - Z\beta)' W^{-1} (P - Z\beta) \quad (6-15)$$

Thus, the maximum likelihood estimates are the vectors β_{ML} and ω_{ML} that minimize $\log L(\beta, \omega)$. Usually there are many more fit parameters than dispersion parameters; that is, the dimension of β is much larger than ω . As such, it is advantageous to reduce the number of parameters involved in the minimization of $\log L(\beta, \omega)$. The key is to realize that equation (6-15) is conditionally linear with respect to β . Hence, given estimates of ω , equation (6-15) can be differentiated directly with respect to β and the resulting expression set to zero. This equation can be solved directly for β as follows:

$$\beta = (Z'W^{-1}Z)^{-1} (Z'W^{-1}P) \quad (6-16)$$

The key point is that now the likelihood depends only upon the dispersion parameter vector ω , which as already discussed has only modest dimensions. Once the likelihood is minimized to yield ω_{ML} , then, since $W(\omega_{ML})$ is then known, equation (6-16) can subsequently be used to determine β_{ML} .

Global Model Selection

Before undertaking the minimization of Equation 6-15 (see “Two-Stage Models” on page 6-109) it is first necessary to establish the form of the X_i

matrix. This is equivalent to establishing a global expression for each of the response features a priori. Univariate stepwise regression is used to select the form of the global model for each response feature. Minimization of the appropriate PRESS statistic is used as a model building principle, as specified in “Stepwise in the Model Building Process” on page 6-94. The underlying principle is that having used univariate methods to establish possible models, maximum likelihood methods are subsequently used to estimate their parameters.

Initial Values for Covariances

An initial estimate of the global covariance is obtained using the standard two-stage estimate of Steimer *et al.* [10],

$$D_{\text{STS}} = \frac{1}{r-1} \sum_{i=1}^r (\mathbf{p}_i - \mathbf{X}_i \boldsymbol{\beta})(\mathbf{p}_i - \mathbf{X}_i \boldsymbol{\beta})^T \quad (6-17)$$

where $\boldsymbol{\beta}$ are the estimates from all the univariate global models. This estimate is biased.

Quasi-Newton Algorithm

Implicit to the minimization of equation (6-17) is that D is positive definite. It is a simple matter to ensure this by noting that D is positive definite if and only if there is an upper triangular matrix, G , say, such that

$$D = G'G \quad (6-18)$$

This factorization is used in the Quasi-Newton algorithm. Primarily, the advantage of this approach is that the resulting search in G , as opposed to D , is unconstrained.

Expectation Maximization Algorithm

The expectation maximization algorithm is an iterative method that converges toward the maximal solution of the likelihood function. Each iteration has two steps:

- 1 Expectation Step — Produce refined estimates of the response features given the current parameter estimates.

- 2** Maximization Step — Obtain new estimates of the parameters (global model parameters and covariance matrix) for the new response features.

These steps are repeated until the improvement in value of the log likelihood function is less than the tolerance. Details of the algorithm can be found in [3, Chapter 5].

References

- 1** Holliday, T., *The Design and Analysis of Engine Mapping Experiments: A Two-Stage Approach*, Ph.D. thesis, University of Birmingham, 1995.
- 2** Holliday, T., Lawrance, A. J., Davis, T. P., Engine-Mapping Experiments: A Two-Stage Regression Approach, *Technometrics*, 1998, Vol. 40, pp 120-126.
- 3** Davidian, M., Giltinan, D. M., *Nonlinear Models for Repeated Measurement Data*, Chapman & Hall, First Edition, 1995.
- 4** Davidian, M., Giltinan, D. M., Analysis of repeated measurement data using the nonlinear mixed effects model, *Chemometrics and Intelligent Laboratory Systems*, 1993, Vol. 20, pp 1-24.
- 5** Davidian, M., Giltinan, D. M., Analysis of repeated measurement data using the nonlinear mixed effects model, *Journal of Biopharmaceutical Statistics*, 1993, Vol. 3, part 1, pp 23-55.
- 6** Lindstrom, M. J., Bates, D. M., Nonlinear Mixed Effects Models for Repeated Measures Data, *Biometrics*, 1990, Vol. 46, pp 673-687.
- 7** Davidian, M., Giltinan, D. M., Some Simple Methods for Estimating Intraindividual Variability in Nonlinear Mixed Effects Models, *Biometrics*, 1993, Vol. 49, pp 59-73.
- 8** Hand, D. J., Crowder, M. J., *Practical Longitudinal Data Analysis*, Chapman and Hall, First Edition, 1996.
- 9** Franklin, G.F., Powell, J.D., Workman, M.L., *Digital Control of Dynamic Systems*, Addison-Wesley, Second Edition, 1990.
- 10** Steimer, J.-L., Mallet, A., Golmard, J.L., and Boisvieux, J.F., Alternative approaches to estimation of population pharmacokinetic parameters:

Comparison with the nonlinear mixed effect model. *Drug Metabolism Reviews*, 1984, 15, 265-292.

Linear Regression

Building a regression model that includes only a subset of the total number of available terms involves a trade-off between two conflicting objectives:

- Increasing the number of model terms always reduces the Sum Squared Error.
- However, you do not want so many model terms that you overfit by chasing points and trying to fit the model to signal noise. This reduces the predictive value of your model.

The best regression equation is the one that provides a satisfactory trade-off between these conflicting goals, at least in the mind of the analyst. It is well known that there is no unique definition of *best*. Different model building criteria (for example, forward selection, backward selection, PRESS search, stepwise search, Mallows C_p Statistic...) yield different models. In addition, even if the optimal value of the model building statistic is found, there is no guarantee that the resulting model will be optimal in any other of the accepted senses.

Principally the purpose of building the regression model for calibration is for predicting future observations of the mean value of the response feature. Therefore the aim is to select the subset of regression terms such that PRESS is minimized. Minimizing PRESS is consistent with the goal of obtaining a regression model that provides good predictive capability over the experimental factor space. This approach can be applied to both polynomial and spline models. In either case the model building process is identical.

- 1** The regression matrix can be viewed in the Design Evaluation Tool. Terms in this matrix define the *full model*. In general, the stepwise model is a subset of this full term set.
- 2** All regressions are carried out with the factors represented on their coded scales (-1,1).

Toolbox Terms and Statistics Definitions

Definitions

Symbol	Definition
N	Number of data points
p	Number of terms currently included in the model
q	Total number of possible model parameters ($q=p+r$)
r	Number of terms not currently included from the model
y	(Nx1) response vector
X	Regression matrix. X has dimensions (Nxq)
X_p	(Nxp) model matrix corresponding to terms currently included in the model
X_r	(Nxr) matrix corresponding to terms currently excluded from the model
β_p	(px1) vector of model coefficients $\beta_p = \{\beta_1, \beta_2, \dots, \beta_p\}$ $\hat{\beta} = (X^T X)^{-1} X^T y$ $\text{var} \hat{\beta} = (X^T X)^{-1} \text{MSE}$
PEV	Prediction Error Variance $\text{PEV}(x) = \text{var} y(\hat{y}) = x(X^T X)^{-1} x^T \text{MSE}$
α	User-defined threshold criteria for automatically rejecting terms
\hat{y}	(Nx1) vector of predicted responses. $\hat{y} = X_p \beta_p$

Definitions (Continued)

Symbol	Definition
e	(N×1) residual vector. $e = (y - \hat{y})$
$e_{(i)}$	(N×1) vector of PRESS residuals. $e_{(i)} = e_i / (1 - H_{ii})$
H	Hat matrix. $X'(X'X)^{-1}X$
L	(N×1) vector of leverage values. $L = \{l_1, l_2, \dots, l_N\}' = \{H_{11}, H_{22}, \dots, H_{NN}\}$
VIF	Variance Inflation Factors
SSE	Error Sum of Squares. $SSE = e'e$
SSR	Regression Sum of Squares. $SSE =$ $\sum e_i^2$
SST	Total Sum of Squares. $SST = y'y - N\bar{y}^2$
MSE	Mean Square Error. $MSE = SSE/(N-p)$
MSR	Mean Square of Regression. $MSR = SSR/P$
F	F-statistic. $F = MSR/MSE$
$MSE_{(i)}$	MSE calculated with i^{th} point removed from the data set. $MSE_{(i)} = \frac{(N-p)MSE - e_i^2 / (1 - H_{ii})}{N-p-1}$
RMSE	Root Mean Squared Error: the standard deviation of regression. $RMSE = \sqrt{MSE}$

Definitions (Continued)

Symbol	Definition
s_i	<p>i^{th} R-Student or Externally Scaled Studentized Residual.</p> $s_i = \frac{e_i}{\sqrt{MSE_{(i)}(1 - H_{ii})}}$
r_i	<p>i^{th} Standardized or Internally Scaled Studentized Residual.</p> $r_i = \frac{e_i}{\sqrt{MSE(1 - H_{ii})}}$
D	<p>Cook's D Influence Diagnostic.</p> $D_i = \frac{r_i^2 H_{ii}}{p(1 - H_{ii})}$
SEBETA	<p>($p \times 1$) vector of model coefficient standard errors.</p> $SEBETA = MSE [\sqrt{c_{11}}, \sqrt{c_{22}}, \dots, \sqrt{c_{pp}}]'$ <p>where $c = (X^T X)^{-1}$</p>
PRESS	<p>Predicted Error Sum of Squares. $PRESS = e'_{(i)} e_{(i)}$</p>

For more on PRESS and other displayed statistics, see "PRESS statistic" on page 6-97, Summary Table on page 6-30, and "Pooled Statistics" on page 6-10.

Export Models to MATLAB, Simulink, and CAGE

You can export models from the Model Browser by selecting **File > Export Models**.

In the Export Models dialog box, select the destination from the **Export to** list. You can export models to:

- Simulink for simulation or for hardware-in-the-loop (HIL) testing. See “Export Models to Simulink” on page 6-118.
- MATLAB to evaluate models in the workspace. See “Export Models to the Workspace” on page 6-123.
- CAGE to create calibrations (either directly or via a file). You can select CAGE if the CAGE Browser is open, or choose **File** to export to CAGE via a file. For more flexibility, use the CAGE Import Tool instead of exporting from the Model Browser. See “CAGE Import Tool” in the CAGE documentation.

Note If you have two global inputs, export to a point-by-point tradeoff in CAGE is a special case where you can use a separate export tool by selecting **Test Plan > Export Point-by-Point Models**. See “Exporting Point-by-Point Models to CAGE” on page 1-11.

Export Models to Simulink

In this section...
“Export Models for Simulation” on page 6-118
“Use Statistical Models for Plant Modeling and Optimization” on page 6-120
“Use Statistical Models for Hardware-in-the-Loop Testing” on page 6-122

Export Models for Simulation

You can export statistical models developed in the Model Browser to a Simulink model for simulation and hardware-in-the-loop (HIL) testing.

- 1 From the Model Browser test plan or any model node, select **File > Export Models**. The Export Models dialog box opens.

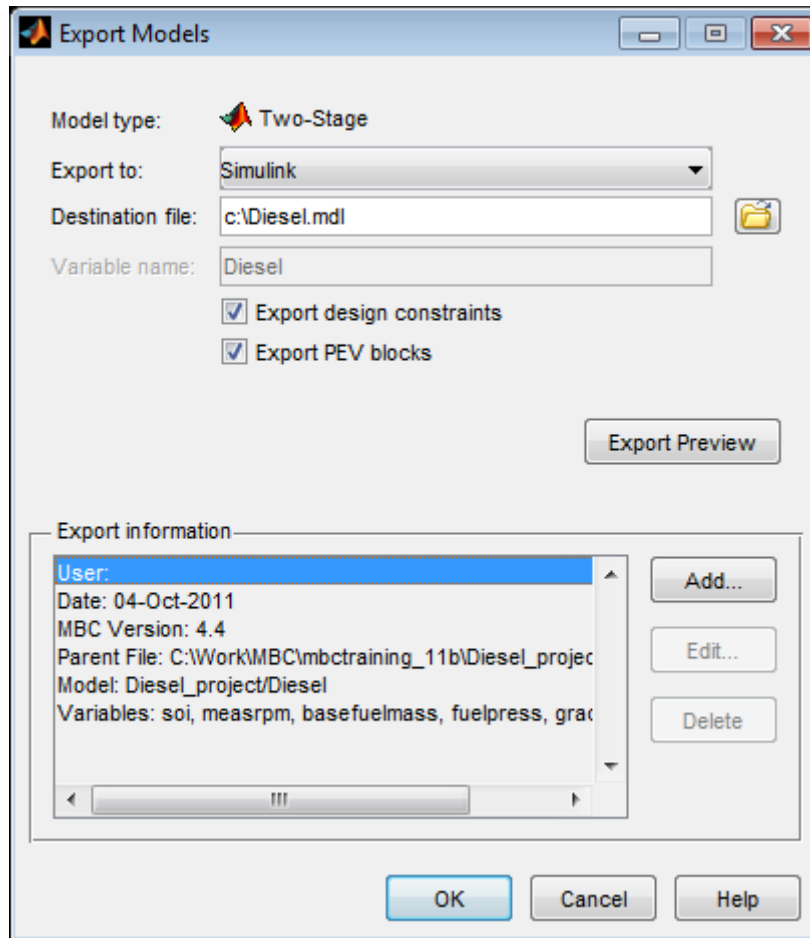

- 2 Select Simulink from the **Export to** list.
- 3 Edit the **Destination file** name if desired, or browse to locate a destination file using a file browser.
- 4 If you have design constraints, they are exported, unless you clear the **Export design constraints** check box.
- 5 If your model supports PEV blocks, they are exported, unless you clear the **Export PEV blocks** check box. This option creates a PEV block as

part of the Simulink diagram so that you can evaluate the prediction error variance along with the model.

- 6 (Optional) Click **Export Preview** to check the models you have selected for export:
 - From the test plan node, you export all the response models in the test plan (provided you have selected best models for them all), or point-by-point models (when all local models are multiple models).
 - From a local model, you export all the local models as a point-by-point model.
 - From other model nodes, you export only the current model.
 - The **Model type** field on the Export Models dialog box displays the model type you are exporting: two-stage, point-by-point, or other model type.
- 7 (Optional) Click **Add** to add a comment to **Export information**.
- 8 Click **OK** to export the models to your specified destination file.

If you export a group of models, each model creates a block in the Simulink diagram.

To export boundary constraint models to Simulink, use the Boundary Editor.

- 1 From the Model Browser test plan, select **TestPlan > Boundary Models**, or click the toolbar button Edit Boundary Models.
- 2 In the Boundary Editor, select **File > Export to Simulink**.

This action exports the currently selected node as a block in a Simulink model. For leaf nodes, the toolbox exports a single boundary model. If the selected node is a parent node (root, local, global, or response) the toolbox exports the boundary or combination of boundaries that you selected as best.

Use Statistical Models for Plant Modeling and Optimization

You can use statistical models developed in the toolbox to capture real-world complex physical phenomena that are difficult to model using traditional

mathematical and physical modeling. For example, you can export models for torque, fuel consumption, and emission (such as engine-out HC, CO, NO_x, and CO₂) to Simulink. You can then perform powertrain matching, fuel economy, performance, and emission simulations to improve powertrain component selections, drivability-related controls, and emission-related controls.

The key physical components of your model are derived from measured engine performance data. Therefore your models yield more accurate results than detailed physical models derived from theory that do not capture the complete physical phenomenon of the real-world system.

You can also reduce the time taken by computationally intensive simulations by creating an accurate statistical surrogate model of an existing detailed high-fidelity engine model. For example, you can use the toolbox to generate accurate, fast-running models from complex Simulink models or subsystems over the design space of interest. The statistical surrogate can then replace the long-running subsystems in Simulink to speed up simulation time.

This graphic describes the model-based calibration workflow. You can use the accurate statistical engine model to replace the high-fidelity simulation and run much faster.

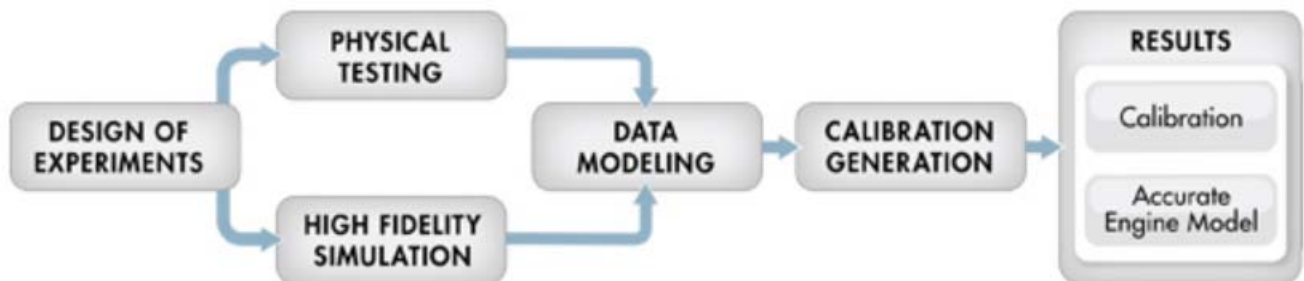

For examples of applications, see the <http://www.mathworks.com/products/mbc/userstories.html> web page.

Use Statistical Models for Hardware-in-the-Loop Testing

You can use Model Browser statistical models exported to Simulink in real-time simulations with hardware to provide fast, accurate plant model emulation to the ECU sensor and actuator harnesses. Exported models can help you explore the effects of calibration changes in simulation without using prototype vehicles. You can simulate and test multiple engine and calibration options for earlier validation of ECU algorithm designs.

In the workflow graphic, this is represented by the Results section, where you can use the accurate engine model to fine-tune the calibration in simulation.

For examples of applications, see the <http://www.mathworks.com/products/mbc/userstories.html> web page.

Export Models to the Workspace

In this section...
“Export Models to MATLAB” on page 6-123
“Work with Models in the Workspace” on page 6-125
“Evaluate Response Models and PEV” on page 6-125
“Evaluate Confidence Intervals” on page 6-126
“Evaluate Boundary Models in the Workspace” on page 6-127

Export Models to MATLAB

You can export models to the workspace to work with them in MATLAB.

- 1 From the Model Browser test plan or any model node, select **File > Export Models**. The Export Models dialog box opens.

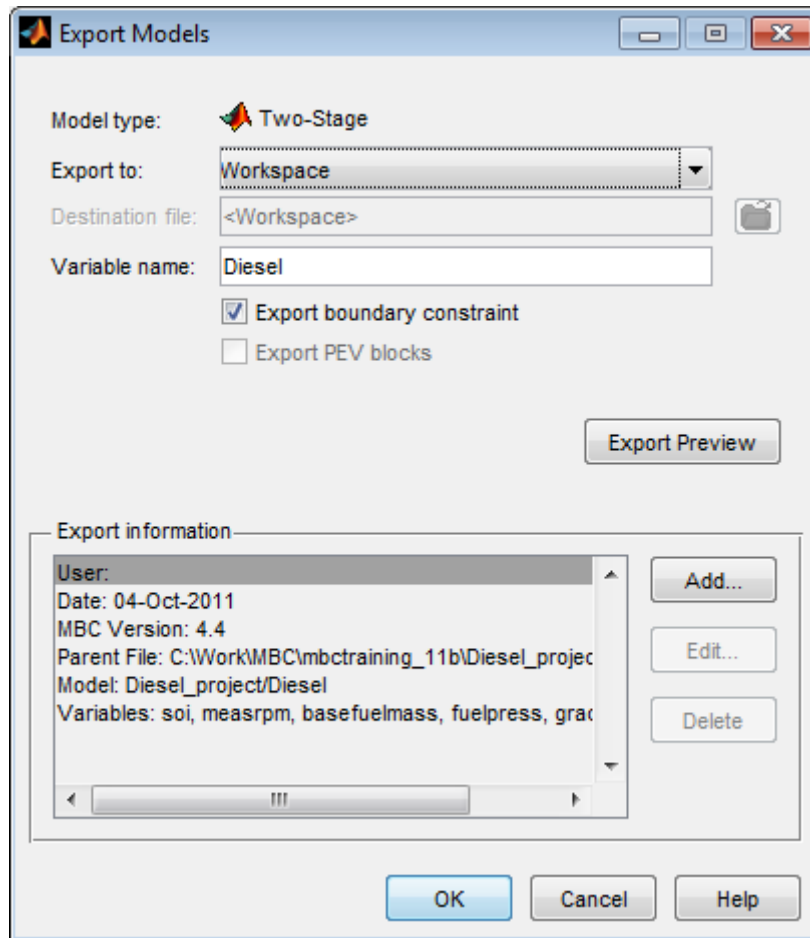

- 2 Select **Workspace** from the **Export to** list.
- 3 Edit the **Variable name** if desired.
- 4 If you have a boundary constraint, it is exported unless you clear the **Export boundary constraint** check box.
- 5 (Optional) Click **Export Preview** to check the models you selected for export:

- From the test plan node, you export all the response models in the test plan (provided you have selected best models for them all), or point-by-point models (when all local models are multiple models).
- From a local model, you export all the local models as a point-by-point model.
- From other model nodes, you export only the current model.
- The **Model type** field on the Export Models dialog box displays the type of model you are exporting: two-stage, point-by-point, or other model type.

6 (Optional) Click **Add** to add a comment to **Export information**.

7 Click **OK** to export the models to the workspace.

Work with Models in the Workspace

After exporting the model to the workspace, you can:

- Evaluate the model.
- Evaluate the prediction error variance (PEV).
- Evaluate the boundary model.
- Calculate confidence intervals for model prediction.

Exported models appear in your workspace as an `xregstatsmodel` or `mbcPointByPointModel` object, or a cell array of models. You use the same commands to evaluate `xregstatsmodel` or `mbcPointByPointModel` models.

If you export a group of models, the toolbox exports a cell array of models. The argument order in the cell array {1 to n} corresponds to the top-down model order in the model tree in the Model Browser.

Evaluate Response Models and PEV

For example, if you export a model to the workspace as `MyModel` and the model has four input factors, evaluate the model at a point as shown here:

```
Y = MyModel([3.7, 89.55, -0.005, 1]);
```

If you create column vectors `p1,p2,p3,p4` (of equal length) for each input factor, you can evaluate the model to give a column vector output:

```
Y = MyModel([p1,p2,p3,p4]);
```

Left-to-right argument order corresponds to the top-down input order in the Test Plan view in the Model Browser.

The inputs and outputs for MATLAB model evaluation are in natural engineering units, not coded units.

You can evaluate the PEV for the model using the command:

```
[pev, y] = pev(MyModel, [x1 x2 x3])
```

You can use one or two arguments, as follows:

```
[p] = pev(x) gives pev at x.
```

```
[p,y] = pev(x) gives pev at x and model evaluation at x.
```

For more information, see `xregstatsmodel`.

Evaluate Confidence Intervals

Use `predint` to evaluate the model confidence intervals:

```
Interval = predint(StatsModel,X,Level);
```

This command calculates the confidence interval for model prediction. A `Level` confidence interval of the predictions is calculated about the predicted value. The default value for `Level` is `99`. `Interval` is an `Nx2` array where the first column is the lower bound and the second column is the upper bound.

The confidence interval is given by:

```
upperbound = y + t*sqrt(pev)  
lowerbound = y - t*sqrt(pev)
```

where y is the model prediction, and t is the appropriate percentile of the t-statistic, with $df = nObs - 1$ degrees of freedom. The toolbox calculates this using the Statistics Toolbox function `tinv` as follows:

```
t = tinv(p,v)
```

p = confidence level, e.g., 95%

v = degrees of freedom ($n - 1$)

```
t = tinv(1-alpha/2, df)
```

where $\alpha = 0.05$ for 95% confidence intervals.

Evaluate Boundary Models in the Workspace

You can use the function `ceval` to evaluate a boundary constraint exported to the workspace. For example, if your exported model is M , then

```
ceval(M, X)
```

evaluates the boundary constraint attached to M at the points given by the matrix X . Values less than 0 are *inside* the boundary. See “Boundary Model Setup” on page 5-46.

For example, if you exported multiple responses from a test plan as a cell array named `modeltutorial`, entering the following at the command line evaluates the boundary model for the first response `{1}` at the point where all four inputs are 0:

```
ceval(modeltutorial{1}, [0,0,0,0])
```

Response models are in top-down order in the model tree. For example, `{1}` is the top model in the tree under the test plan node. `[0,0,0,0]` is the matrix of input values, where left-to-right argument order corresponds to the top-down input order in the Boundary Editor or the Test Plan view in the Model Browser, e.g., `spk`, `load`, `rpm`, and `afr`.

You can quickly check the number of model inputs as follows:

```
nfactors(modeltutorial{1})
```

You can click a point in the boundary editor (in the 1-D, 2-D, and 3-D views) to check the input names and get example input values to evaluate in the workspace, e.g.,

```
ceval (modeltutorial{1},[25, 0.64, 5000, 14.43])
```

```
ans = 3.0284e-004
```

Boundary constraint distance of 0 means the point is on the boundary, negative values are inside the constraint, and positive values are outside. The range is typically $[-1,1]$ but not always, and roughly linear. Rather like information criteria, it is only a comparison that is meaningful (point x has a greater distance than point y) rather than the absolute value.

For more information, see `xregstatsmodel`.

Radial Basis Functions

This section discusses the following topics:

Radial Basis Functions for Model Building

In this section...

“About Radial Basis Functions” on page 7-2

“Types of Radial Basis Functions” on page 7-3

“Fitting Routines” on page 7-11

“Center Selection Algorithms” on page 7-12

“Lambda Selection Algorithms” on page 7-15

“Width Selection Algorithms” on page 7-19

“Prune Functionality” on page 7-25

“Statistics” on page 7-27

“Hybrid Radial Basis Functions” on page 7-31

“Tips for Modeling with Radial Basis Functions” on page 7-33

About Radial Basis Functions

A radial basis function has the form

$$z(x) = \phi(\|x - \mu\|)$$

where x is a n -dimensional vector, μ is an n -dimensional vector called the center of the radial basis function, $\| \cdot \|$ denotes Euclidean distance, and ϕ is a univariate function, defined for positive input values, that we shall refer to as the profile function.

The model is built up as a linear combination of N radial basis functions with N distinct centers. Given an input vector x , the output of the RBF network is the activity vector \hat{y} given by

$$\hat{y}(x) = z \sum_{j=1}^N \beta_j z_j(x)$$

where β_j is the weight associated with the j th radial basis function, centered at μ_j , and $z_j = \Phi(\|x - \mu_j\|)$. The output \hat{y} approximates a target set of values denoted by y .

A variety of radial basis functions are available in MBC, each characterized by the form of Φ . All of the radial basis functions also have an associated width parameter σ , which is related to the spread of the function around its center. Selecting the box in the model setup provides a default setting for the width. The default width is the average over the centers of the distance of each center to its nearest neighbor. This is a heuristic given in Hassoun (see “References” on page 7-31) for Gaussians, but it is only a rough guide that provides a starting point for the width selection algorithm.

Another parameter associated with the radial basis functions is the regularization parameter λ . This (usually small) positive parameter is used in most of the fitting algorithms. The parameter λ penalizes large weights, which tends to produce smoother approximations of y and to reduce the tendency of the network to overfit (that is, to fit the target values y well, but to have poor predictive capability).

The following sections explain the different parameters for the radial basis functions available in the Model-Based Calibration Toolbox product, and how to use them for modeling.

Types of Radial Basis Functions

- “How to Choose a Kernel” on page 7-4
- “Gaussian” on page 7-4
- “Thin-Plate Spline” on page 7-5
- “Logistic Basis Function” on page 7-6
- “Wendland’s Compactly Supported Function” on page 7-6
- “Multiquadrics” on page 7-8
- “Reciprocal Multiquadrics” on page 7-9
- “Linear” on page 7-10
- “Cubic” on page 7-11

How to Choose a Kernel

Within the Model Setup dialog box, you can choose which RBF kernel to use. Kernels are the types of RBF (multiquadric, gaussian, thinplate, and so on). These types are described in the following sections.

Gaussian

This is the radial basis function most commonly used in the neural network community. Its profile function is

$$\Phi(r) = e^{(-r^2/\sigma^2)}$$

This leads to the radial basis function

$$z(x) = \exp\left(-\frac{\|x - \mu\|^2}{\sigma^2}\right)$$

In this case, the width parameter is the same as the standard deviation of the gaussian function.

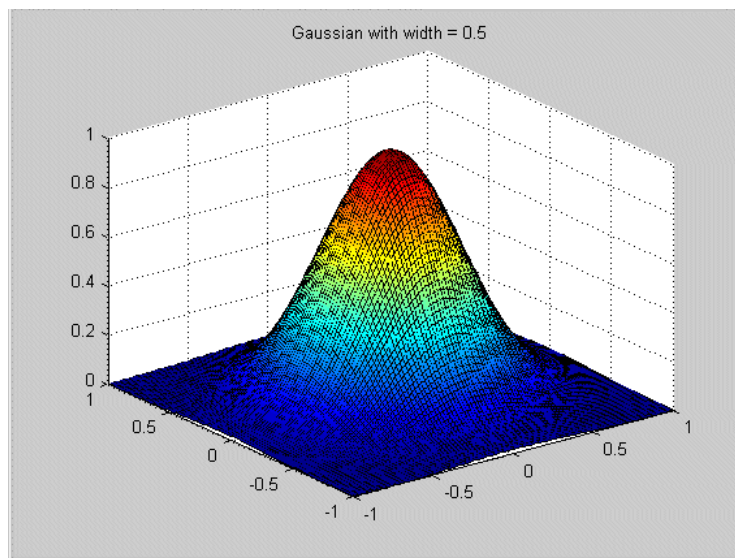

Thin-Plate Spline

This radial basis function is an example of a smoothing spline, as popularized by Grace Wahba (<http://www.stat.wisc.edu/~wahba/>). They are usually supplemented by low-order polynomial terms. Its profile function is

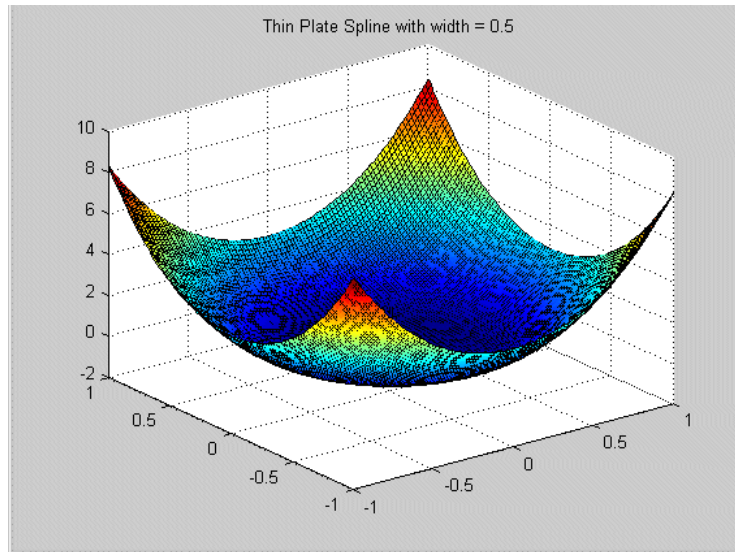

Logistic Basis Function

These radial basis functions are mentioned in Hassoun (see “References” on page 7-31). They have the profile function

$$\Phi(r) = \frac{1}{1 + \exp\left(\frac{r}{\sigma}\right)}$$

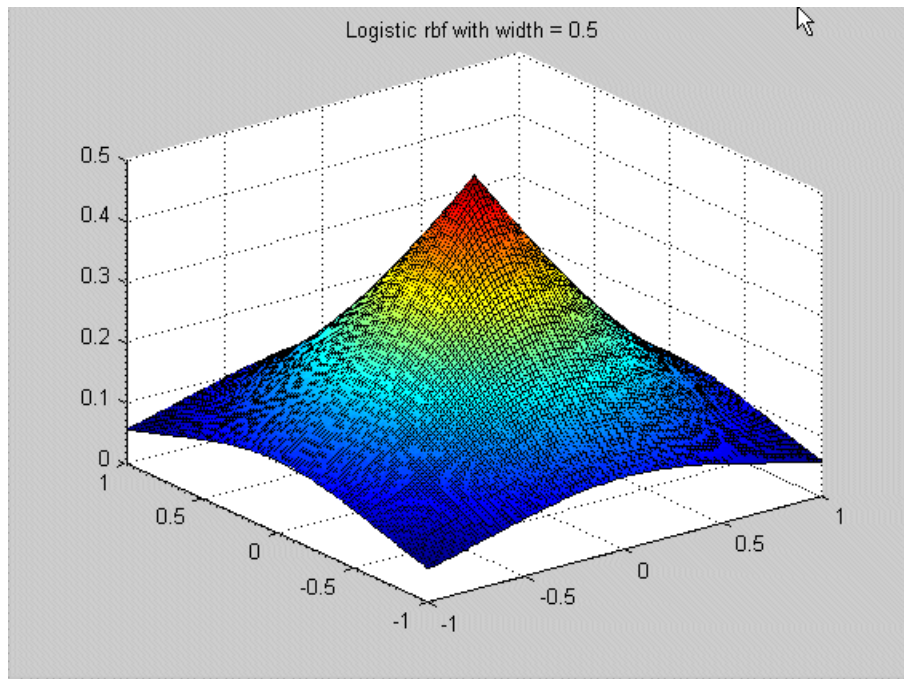

Wendland’s Compactly Supported Function

These form a family of radial basis functions that have a piecewise polynomial profile function and compact support [Wendland, see “References” on page 7-31]. The member of the family to choose depends on the dimension of the space (n) from which the data is drawn and the desired amount of continuity of the polynomials.

Dimension	Continuity	Profile
n=1	0	$\Phi(r) = (1-r)_+$
	2	$\Phi(r) = (1-r)_+^3(3r+1)$
	4	$\Phi(r) = (1-r)_+^5(8r^2+5r+1)$
n=3	0	$\Phi(r) = (1-r)_+^2$
	2	$\Phi(r) = (1-r)_+^4 + (4r+1)$
	4	$\Phi(r) = (1-r)_+^6(35r^2+18r+3)$
n=5	0	$\Phi(r) = (1-r)_+^3$
	2	$\Phi(r) = (1-r)_+^5(5r+1)$
	4	$\Phi(r) = (1-r)_+^7(16r^2+7r+1)$

We have used the notation $a_+ := \begin{cases} a, & a > 0 \\ 0, & a \leq 0 \end{cases}$ for the positive part of a .

When n is even, the radial basis function corresponding to dimension $n+1$ is used.

Note that each of the radial basis functions is nonzero when r is in $[0,1]$. It is possible to change the support to be $[0,\sigma]$ by replacing r by r/σ in the preceding formula. The parameter σ is still referred to as the width of the radial basis function.

Similar formulas for the profile functions exist for $n > 5$, and for even continuity > 4 . Wendland's functions are available up to an even continuity of 6, and in any space dimension n .

Notes on Use.

- Better approximation properties are usually associated with higher continuity.
- For a given data set the width parameter for Wendland's functions should be larger than the width chosen for the Gaussian.

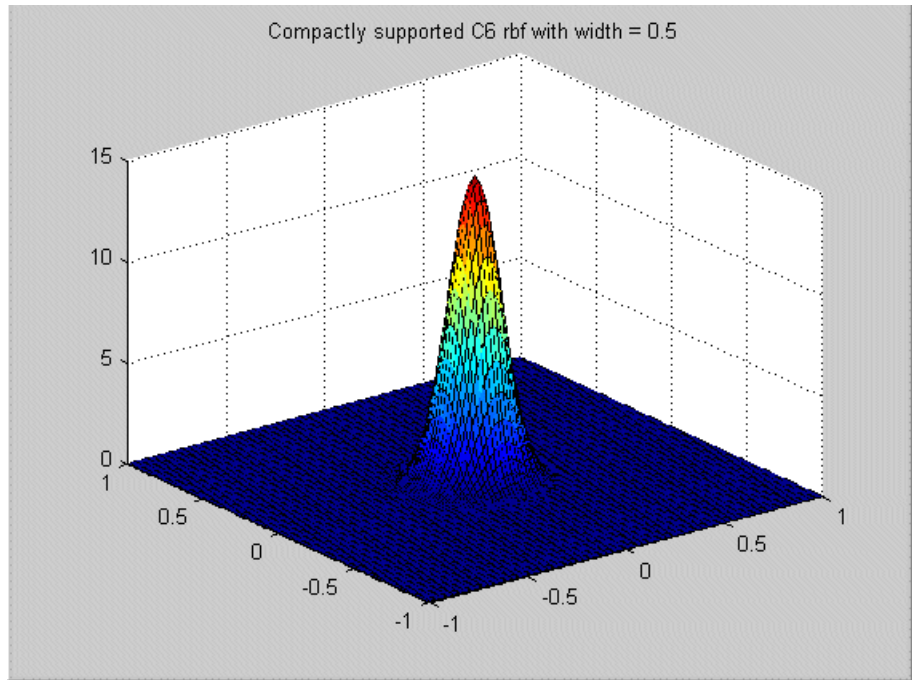

Multiquadrics

These are a popular tool for scattered data fitting. They have the profile function

$$\Phi(r) = \sqrt{r^2 + \sigma^2}$$

Reciprocal Multiquadrics

These have the profile function

$$\Phi(r) = 1/\sqrt{r^2 + \sigma^2}$$

Note that a width σ of zero is invalid.

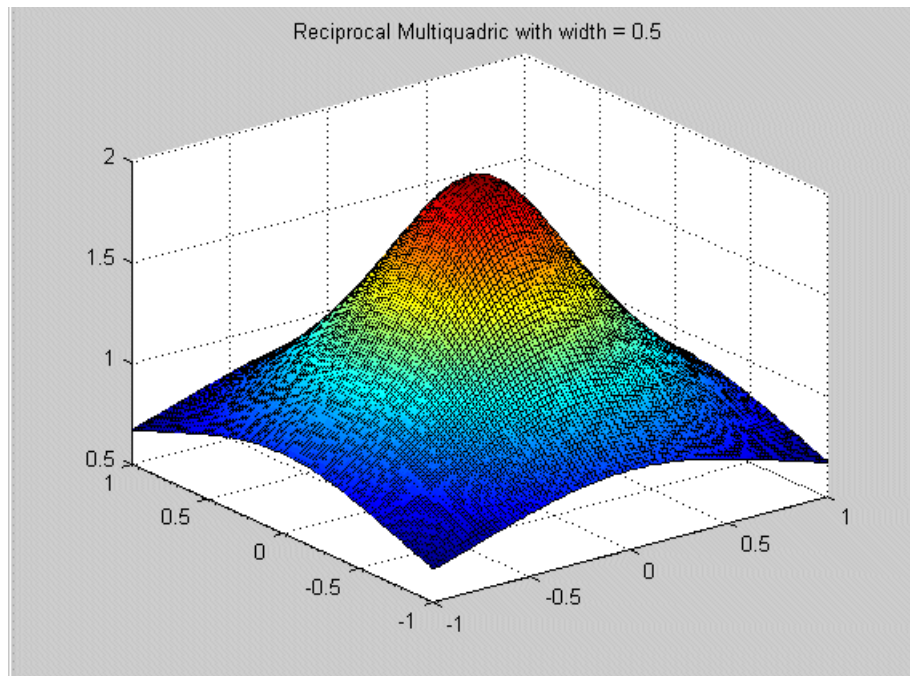

Linear

These have the profile function $\phi = -r$.

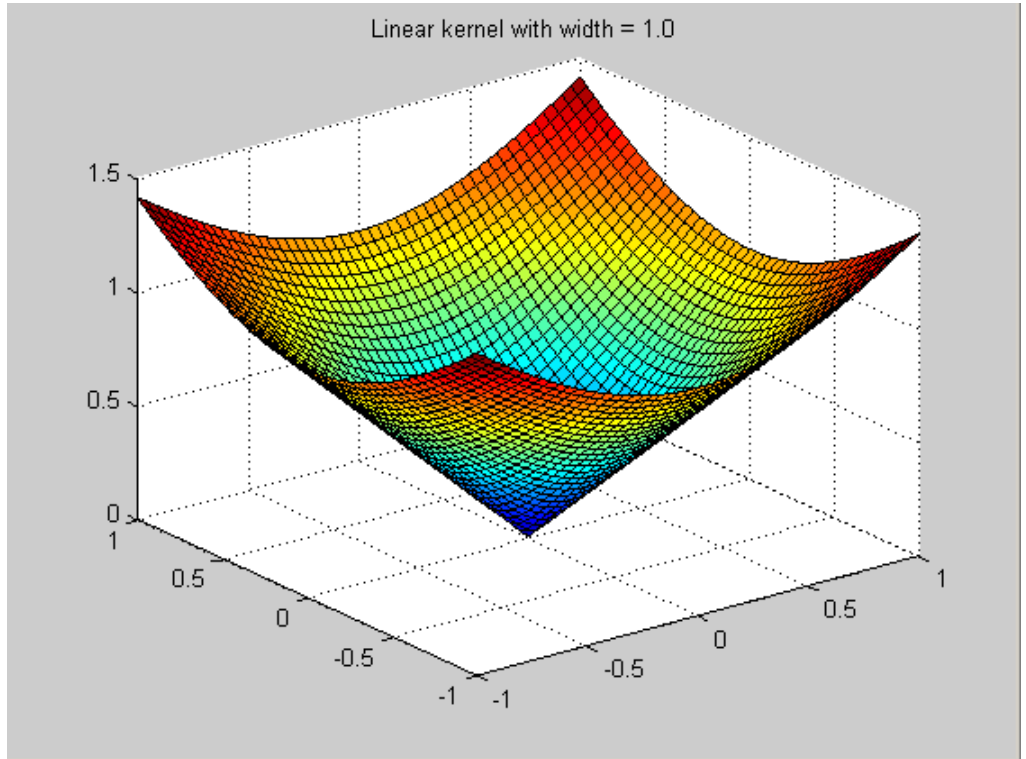

Cubic

These have the profile function $\phi = r^3$.

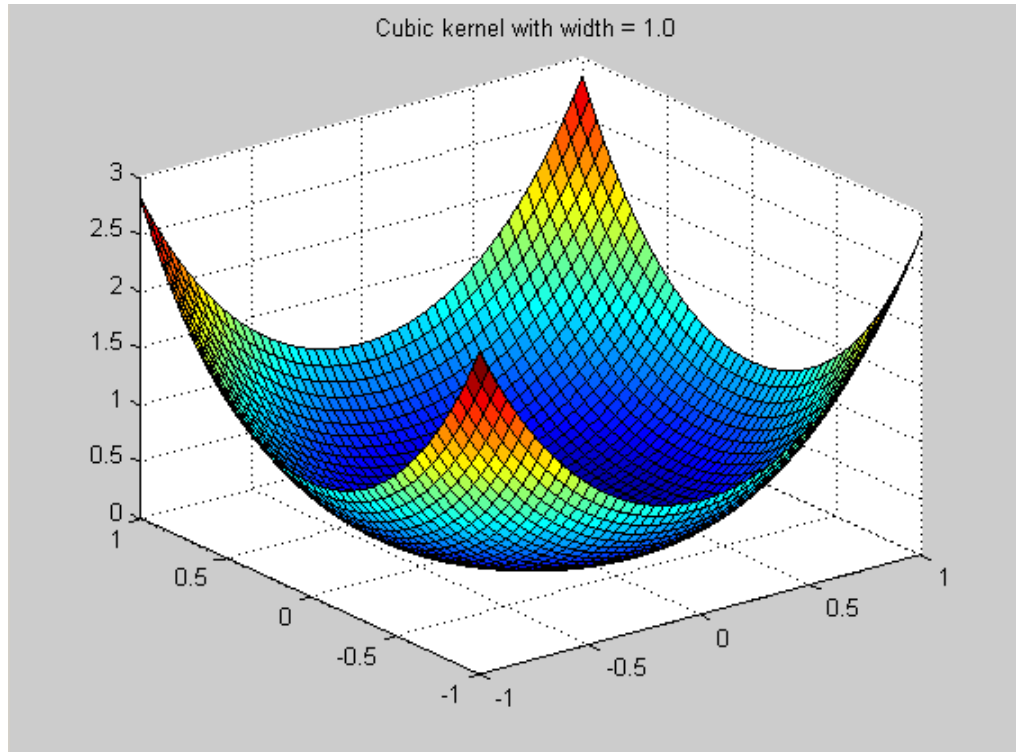

Fitting Routines

There are four characteristics of the RBF that need to be decided: weights, centers, width, and λ . Each of these can have significant impact on the quality of the resulting fit, and good values for each of them need to be determined. The weights are always determined by specifying the centers, width, and λ , and then solving an appropriate linear system of equations. However, the problem of determining good centers, width, and λ in the first place is far from simple, and is complicated by the strong dependencies among the parameters. For example, the optimal λ varies considerably as the width

parameter changes. A global search over all possible center locations, width, and λ is computationally prohibitive in all but the simplest of situations.

To try to combat this problem, the fitting routines come in three different levels.

At the lowest level are the algorithms that choose appropriate centers for given values of width and λ . The centers are chosen one at a time from a candidate set (usually the set of data points or a subset of them). The resulting centers are therefore ranked in a rough order of importance.

At the middle level are the algorithms that choose appropriate values for λ and the centers, given a specified width.

At the top level are the algorithms that aim to find good values for each of the centers, width, and λ . These top-level algorithms test different width values. For each value of width, one of the middle-level algorithms is called that determines good centers and values for λ .

These algorithms and their fit parameters are described in the following sections:

- 1** “Center Selection Algorithms” on page 7-12
- 2** “Lambda Selection Algorithms” on page 7-15
- 3** “Width Selection Algorithms” on page 7-19

Center Selection Algorithms

- “Rols” on page 7-12
- “RedErr” on page 7-14
- “WiggleCenters” on page 7-14
- “CenterExchange” on page 7-14

Rols

This is the basic algorithm as described in Chen, Chng, and Alkadhimi [See “References” on page 7-31]. In Rols (Regularized Orthogonal Least Squares)

the centers are chosen one at a time from a candidate set consisting of all the data points or a subset thereof. It picks new centers in a forward selection procedure. Starting from zero centers, at each step the center that reduces the regularized error the most is selected. At each step the regression matrix X is decomposed using the Gram-Schmidt algorithm into a product $X = WB$ where W has orthogonal columns and B is upper triangular with ones on the diagonal. This is similar in nature to a QR decomposition. Regularized error is given by $e'e + \lambda g'g$ where $g = Bw$ and e is the residual, given by $e = y - \hat{y}$. Minimizing regularized error makes the sum square error $e'e$ small, while at the same time not letting $g'g$ get too large. As g is related to the weights by $g = Bw$, this has the effect of keeping the weights under control and reducing overfit. The term $g'g$ rather than the sum of the squares of the weights $w'w$ is used to improve efficiency.

The algorithm terminates either when the maximum number of centers is reached, or adding new centers does not decrease the regularized error ratio significantly (controlled by a user-defined tolerance).

Fit Parameters. Maximum number of centers — The maximum number of centers that the algorithm can select. The default is the smaller of 25 centers or π of the number of data points. The format is $\min(\text{nObs}/4, 25)$. You can enter a value (for example, entering 10 produces ten centers) or edit the existing formula (for example, $(\text{nObs}/2, 25)$ produces half the number of data points or 25, whichever is smaller).

Percentage of data to be candidate centers — The percentage of the data points that should be used as candidate centers. This determines the subset of the data points that form the pool to select the centers from. The default is 100%, that is, to consider all the data points as possible new centers. This can be reduced to speed up the execution time.

Regularized error tolerance — Controls how many centers are selected before the algorithm stops. See Chen, Chng, and Alkadhimi [“References” on page 7-31] for details. This parameter should be a positive number between 0 and 1. Larger tolerances mean that fewer centers are selected. The default is 0.0001. If less than the maximum number of centers is being chosen, and you want to force the selection of the maximum number, then reduce the tolerance to epsilon (eps).

RedErr

RedErr stands for Reduced Error. This algorithm also starts from zero centers, and selects centers in a forward selection procedure. The algorithm finds (among the data points not yet selected) the data point with the largest residual, and chooses that data point as the next center. This process is repeated until the maximum number of centers is reached.

Fit Parameters. Only has **Number of centers**.

WiggleCenters

This algorithm is based on a heuristic that you should put more centers in a region where there is more variation in the residual. For each data point, a set of neighbors is identified as the data points within a distance of \sqrt{nf} divided by the maximum number of centers, where nf is the number of factors. The average residuals within the set of neighbors is computed, then the amount of wiggle of the residual in the region of that data point is defined to be the sum of the squares of the differences between the residual at each neighbor and the average residuals of the neighbors. The data point with the most wiggle is selected to be the next center.

Fit Parameters. Almost as in the RoIs algorithm, except no **Regularized error**.

CenterExchange

This algorithm takes a concept from optimal Design of Experiments and applies it to the center selection problem in radial basis functions. A candidate set of centers is generated by a Latin hypercube, a method that provides a quasi-uniform distribution of points. From this candidate set, n centers are chosen at random. This set is augmented by p new centers, then this set of $n+p$ centers is reduced to n by iteratively removing the center that yields the best PRESS statistic (as in stepwise). This process is repeated the number of times specified in **Number of augment/reduce cycles**.

CentreExchange and Tree Regression (see “Tree Regression” on page 7-22) are the only algorithms that permit centers that are not located at the data points. This means that you do not see centers on model plots. The CentreExchange algorithm has the potential to be more flexible than the other center selection algorithms that choose the centers to be a subset of

the data points; however, it is significantly more time consuming and not recommended on larger problems.

Fit Parameters. Number of centers — The number of centers that will be chosen

Number of augment/reduce cycles — The number of times that the center set is augmented, then reduced

Number of centers to augment by — How many centers to augment by

Lambda Selection Algorithms

- “IterateRidge” on page 7-15
- “IterateRols” on page 7-16
- “StepItRols” on page 7-18

Lambda is the regularization parameter.

IterateRidge

For a specified width, this algorithm optimizes the regularization parameter with respect to the GCV criterion (generalized cross-validation; see the discussion under GCV criterion).

The initial centers either are selected by one of the low-level center selection algorithms or the previous choice of centers is used (see discussion under the parameter **Do not reselect centers**). You can select an initial start value for λ by testing an initial number of values for lambda (set by the user) that are equally spaced on a logarithmic scale between 10^{-10} and 10 and choosing the one with the best GCV score. This helps avoid falling into local minima on the GCV - λ curve. The parameter λ is then iterated to try to minimize GCV using the formulas given in the GCV criterion section. The iteration stops when either the maximum number of updates is reached or the $\log_{10}(\text{GCV})$ value changes by less than the tolerance.

Fit Parameters. Center selection algorithm — The center selection algorithm to use.

Maximum number of updates — Maximum number of times that the update of λ is made. The default is 10.

Minimum change in log10(GCV) — Tolerance. This defines the stopping criterion for iterating λ ; the update stops when the difference in the log10(GCV) value is less than the tolerance. The default is 0.005.

Number of initial test values for lambda — Number of test values of λ to determine a starting value for λ . Setting this parameter to 0 means that the best λ so far is used.

Do not reselect centers for new width — This check box determines whether the centers are reselected for the new width value, and after each lambda update, or if the best centers to date are to be used. It is cheaper to keep the best centers found so far, and often this is sufficient, but it can cause premature convergence to a particular set of centers.

Display — When you select this check box, this algorithm plots the results of the algorithm. The starting point for λ is marked with a black circle. As λ is updated, the new values are plotted as red crosses connected with red lines. The best λ found is marked with a green asterisk.

If too many graphs are likely to be produced, because of the **Display** check box being activated here, a warning is generated, and you have the option to stop execution.

A lower bound of 10^{-12} is placed on λ , and an upper bound of 10.

IterateRols

For a specified width, this algorithm optimizes the regularization parameter in the Rols algorithm with respect to the GCV criterion. An initial fit and the centers are selected by Rols using the user-supplied λ . As in `IterateRidge`, you select an initial start value for λ by testing an initial number of start values for lambda that are equally spaced on a logarithmic scale between 10^{-10} and 10, and choosing the one with the best GCV score.

λ is then iterated to improve GCV. Each time that λ is updated, the center selection process is repeated. This means that `IterateRols` is much more computationally expensive than `IterateRidge`.

A lower bound of 10^{-12} is placed on λ , and an upper bound of 10.

Fit Parameters. Center selection algorithm — The center selection algorithm to use. For `IterateRols` the only center selection algorithm available is `Rols`.

Maximum number of updates — The same as for `IterateRidge`.

Minimum change in $\log_{10}(\text{GCV})$ — The same as for `IterateRidge`.

Number of initial test values for lambda — The same as for `IterateRidge`.

Do not reselect centers for new width — This check box determines whether the centers are reselected for the new width value or if the best centers to date are to be used.

Display — When you select this check box, this algorithm plots the results of the algorithm. The starting point for λ is marked with a black circle.

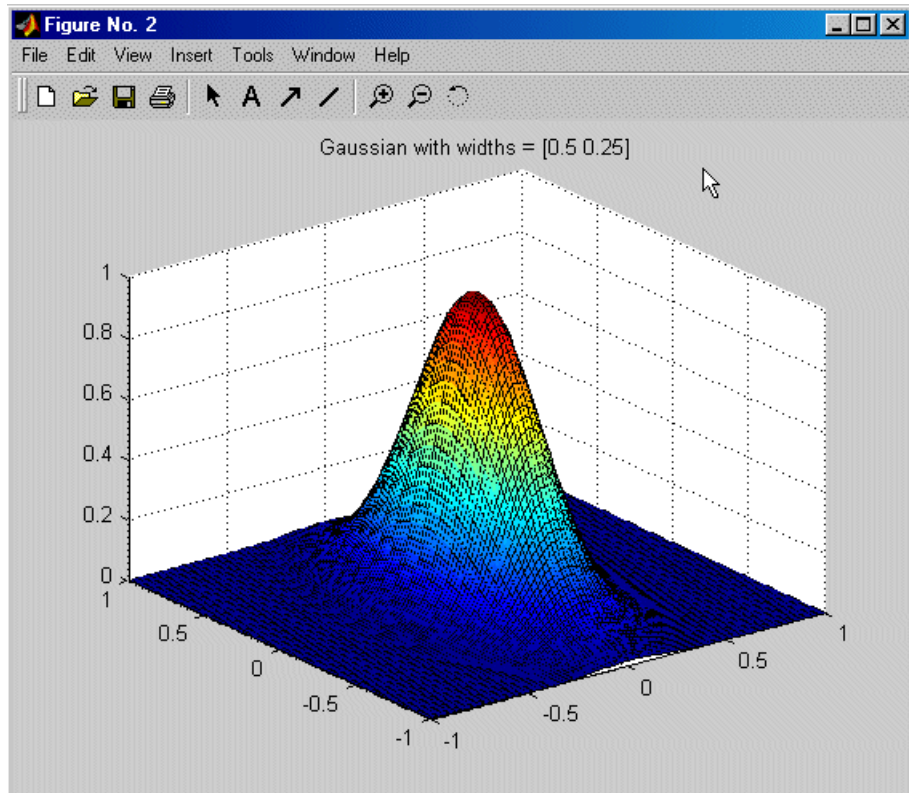

As the above figure is updated, the new values are plotted as red crosses connected with red lines. The best  found is marked with a green asterisk.

If too many graphs are likely to be produced, because of the **Display** check box being activated here, a warning is generated, and you have the option to stop execution.

StepItRols

This algorithm combines the center-selection and lambda-selection processes.

Rather than waiting until all centers are selected before  is updated (as with the other lambda-selection algorithms), this algorithm offers the ability to update λ after each center is selected. It is a forward selection algorithm

that, like `Rols`, selects centers on the basis of regularized error reduction. The stopping criterion for `StepItRols` is on the basis of $\log_{10}(\text{GCV})$ changing by less than the tolerance more than a specified number of times in a row (given in the parameter **Maximum number of times $\log_{10}(\text{GCV})$ change is minimal**). Once the addition of centers has stopped, the intermediate fit with the smallest $\log_{10}(\text{GCV})$ is selected. This can involve removing some of the centers that entered late in the algorithm.

Fit Parameters. Maximum number of centers — As in the `Rols` algorithm.

Percentage of data to candidate centers — As in the `Rols` algorithm.

Number of centers to add before updating — How many centers are selected before iterating λ begins.

Minimum change in $\log_{10}(\text{GCV})$ — Tolerance. It should be a positive number between 0 and 1. The default is 0.005.

Maximum number of times $\log_{10}(\text{GCV})$ change is minimal — Controls how many centers are selected before the algorithm stops. The default is 5. Left at the default, the center selection stops when the $\log_{10}(\text{GCV})$ values change by less than the tolerance five times in a row.

Width Selection Algorithms

- “TrialWidths” on page 7-19
- “WidPerDim” on page 7-20
- “Tree Regression” on page 7-22

TrialWidths

This routine tests several width values by trying different widths. A set of trial widths equally spaced between specified initial upper and lower bounds is selected. The width with the lowest value of $\log_{10}(\text{GCV})$ is selected. The area around the best width is then tested in more detail — this is referred to as a zoom. Specifically, the new range of trial widths is centered on the best width found at the previous range, and the length of the interval from

which the widths are selected is reduced to $2/5$ of the length of the interval at the previous zoom. Before the new set of trial widths is tested, the center selection is updated to reflect the best width and λ found so far. This can mean that the location of the optimum width changes between zooms because of the new center locations.

Fit Parameters. Lambda selection algorithm — Midlevel fit algorithm that you test with the various trial values of λ . The default is `IterateRidge`.

Number of trial widths in each zoom — Number of trials made at each zoom. The widths tested are equally spaced between the initial upper and lower bounds. Default is 10.

Number of zooms — Number of times you zoom in. Default is 5.

Initial lower bound on width — Lower bound on the width for the first zoom. Default is 0.01.

Initial upper bound on width — Upper bound on the width for the first zoom. Default is 20.

Display — If you select this check box, a stem plot of $\log_{10}(\text{GCV})$ against width is plotted. The best width is marked by a green asterisk.

WidPerDim

In the `WidPerDim` algorithm (Width Per Dimension), the radial basis functions are generalized. Rather than having a single width parameter, a different width in each input factor can be used; that is, the level curves are elliptical rather than circular (or spherical, with more factors). The basis functions are no longer radially symmetric.

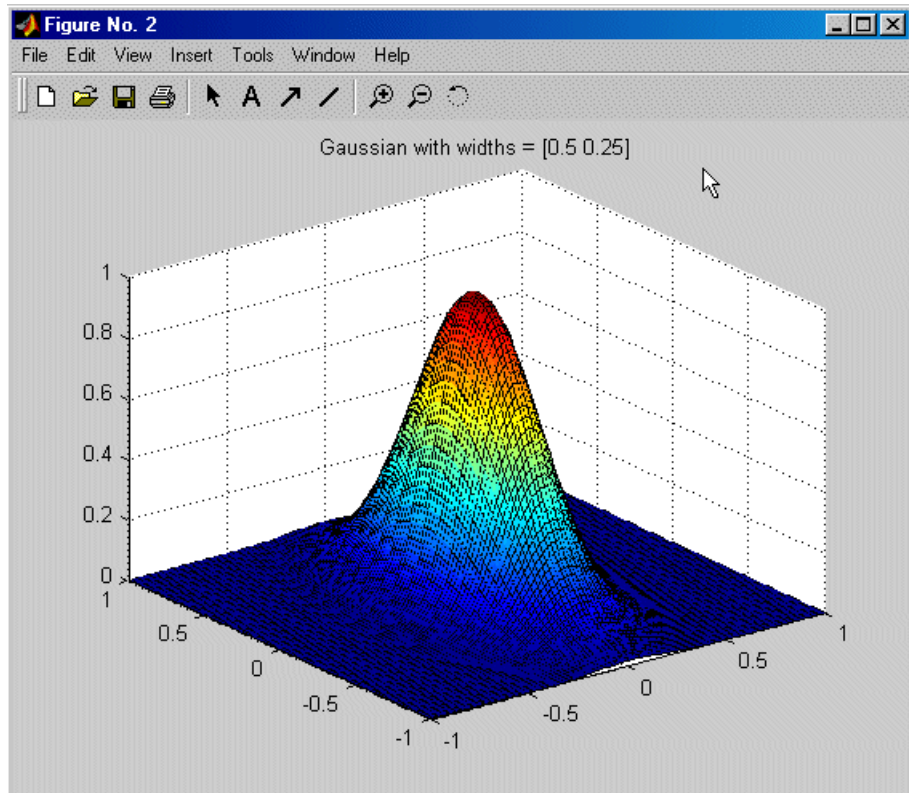

This can be especially helpful when the amount of variability varies considerably in each input direction. This algorithm offers more flexibility than `TrialWidths`, but is more computationally expensive.

You can set **Initial width** in the RBF controls on the Global Model Setup dialog box. For most algorithms the **Initial width** is a single value. However, for `WidPerDim` (available in the **Width selection algorithm** pull down), you can specify a vector of widths to use as starting widths.

If supplying a vector of widths, there should be the same number as the number of global variables, and they must be in the same order as specified in the test plan. If you provide a single width, then all dimensions start off from the same initial width, but are likely to move from there to a vector of widths during model fitting.

An estimation of the time for the width per dimension algorithm is computed. This is given as a number of time units (as it depends on the machine). A time estimate of over 10 but less than 100 generates a warning. A time estimate of over 100 might take a prohibitively long amount of time (probably over five minutes on most machines). You have the option to stop execution and change some of the parameters to reduce the run time.

Fit Parameters. As for the `TrialWidths` algorithm.

Tree Regression

There are three parts to the tree regression algorithm for RBFs:

- Tree building
- Alpha selection
- Center selection.

Tree Building. The tree regression algorithm builds a regression tree from the data and uses the nodes (or panels) of this tree to infer candidate centers and widths for the RBF. The root panel of the tree corresponds to a hypercube that contains all of the data points. This panel is divided into two child panels such that each child contains the same amount of variation, as much as is possible. The child panel with the most variation is then split in a similar way. This process continues until there are no panels left to split, i.e., no childless panel has more than the minimum number of data points, or until the maximum number of panels has been reached. Each panel in the tree corresponds to a candidate center and the size of the panel determines the width that goes with that vector.

The size of the child panels can be based solely on the size of the parent panel or can be determined by shrinking the child panel onto the data that it contains.

Once you have selected `Radial Basis Function` in the Global Model Setup dialog box, you can choose `Tree Regression` from the **Width Selection Algorithm** drop-down menu.

Click **Advanced** to open the Radial Basis Functions Options dialog box to reach settings such as maximum number of panels and minimum number of

data points per panel. To shrink child panels to fit the data, select the check box **Shrink panels to data**.

Alpha Selection Algorithm. The size for the candidate widths are not taken directly from the panel sizes: we need to scale the panel sizes to get the corresponding widths. This scaling factor is called alpha. The same scaling factor needs to be applied to every panel in the tree and to determine the optimal value of alpha we use an alpha selection algorithm.

You can choose the parameter **Specify Alpha** to specify the exact value of alpha to use, or you can select **Trial Alpha**. **Trial Alpha** is very similar to the **Trial Widths** algorithm. The only difference is that the trial alpha algorithm can specify how to space the values to search. **Linear** is the same as used by trial widths but **Logarithmic** searches more values near the lower range.

Click **Advanced** to open the Radial Basis Functions Options dialog box to reach further settings such as bounds on alpha, number of zooms and number of trial alphas. Here you can select the **Display** check box to see the progress of the algorithm and the values of alpha trailed.

Center Selection Algorithm. The tree building generates candidate centers and the alpha selection generates candidate widths for these centers. The center selection chooses which of those centers to use.

Generic Center Selection is a center selection algorithm that knows nothing about the tree structure to be used. It uses **ROLS**, which is very fast way to choose centers and works in this case as well as the usual RBF cases. However, in this case the candidates for centers are not the data by the centers from the regression tree.

Tree-based center selection uses the regression tree. It is natural to use the regression tree to select centers because of the way it is built. In particular, the panel corresponding to the root node should be considered for selection before any of its children as it captures coarse detail while nodes at the leaves of the tree capture fine detail. This is what the **Tree-based center selection** does. You can also set the maximum number of centers.

Click **Advanced** to open the Radial Basis Functions Options dialog box to reach the **Model selection criteria** setting. The **Model selection criteria** determines what function should be used as a measure of how good a model

is. This can be BIC (Bayesian information criterion) or GCV (generalized cross-validation). BIC is usually less susceptible to over fitting.

The Stepwise menu is the same for all RBFs, see “Global Model Class: Radial Basis Function” on page 5-73.

Tree Regression and CentreExchange are the only algorithms that permit centers that are not located at the data points. This means that you do not see centers on model plots.

If you leave the **Alpha selection algorithm** at the default, Trial Alpha, you will see a progress dialog box when you click **OK** to begin modeling. An example is shown.

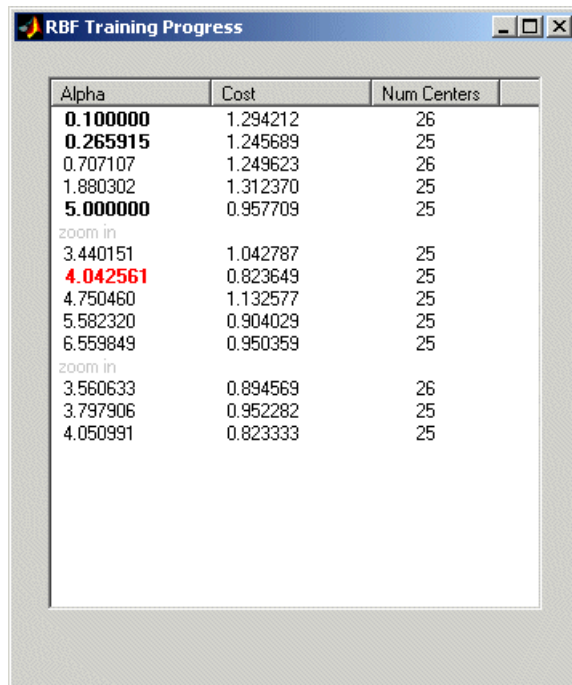

Alpha	Cost	Num Centers
0.100000	1.294212	26
0.265915	1.245689	25
0.707107	1.249623	26
1.880302	1.312370	25
5.000000	0.957709	25
zoom in		
3.440151	1.042787	25
4.042561	0.823649	25
4.750460	1.132577	25
5.582320	0.904029	25
6.559849	0.950359	25
zoom in		
3.560633	0.894569	26
3.797906	0.952282	25
4.050991	0.823333	25

This is an example progress dialog box of a Tree Regression RBF model fitting in progress. Here you can see each trial value of alpha with its calculated cost and the best number of centers with that value of alpha. The alpha value in

red is the best so far. Alpha values no longer red, but in bold, are previous best values. You can then refine your model by zooming in on the best values for alpha and number of centers.

Reference: M. Orr, J. Hallam, K. Takezawa, A. Murray, S. Ninomiya, M. Oide, T. Leonard, "Combining Regression Trees and Radial Basis Function Networks," *International Journal of Neural Systems*, Vol. 10, No. 6 (2000) 453-465.

<http://www.anc.ed.ac.uk/rbf/rbf.html>

Prune Functionality

You can use the Prune function to reduce the number of centers in a radial basis function network. This helps you decide how many centers are needed.

To use the Prune facility:

- 1 Select an RBF global model in the model tree.
- 2 Either click the  toolbar button or select the menu item **Model > Utilities > Prune**.

The Number of Centers Selector dialog box appears.

The graphs show how the fit quality of the network builds up as more RBFs are added. It makes use of the fact that most of the center selection algorithms are greedy in nature, and so the order in which the centers were selected roughly reflects the order of importance of the basis functions.

The default fit criteria are the logarithms of PRESS, GCV, RMSE, and Weighted PRESS. Additional options are determined by your selections in Summary Statistics. See "Model Menu (Global Level)" on page 6-37. Weighted PRESS penalizes having more centers, and choosing number of centers to minimize weighted PRESS is often a good option.

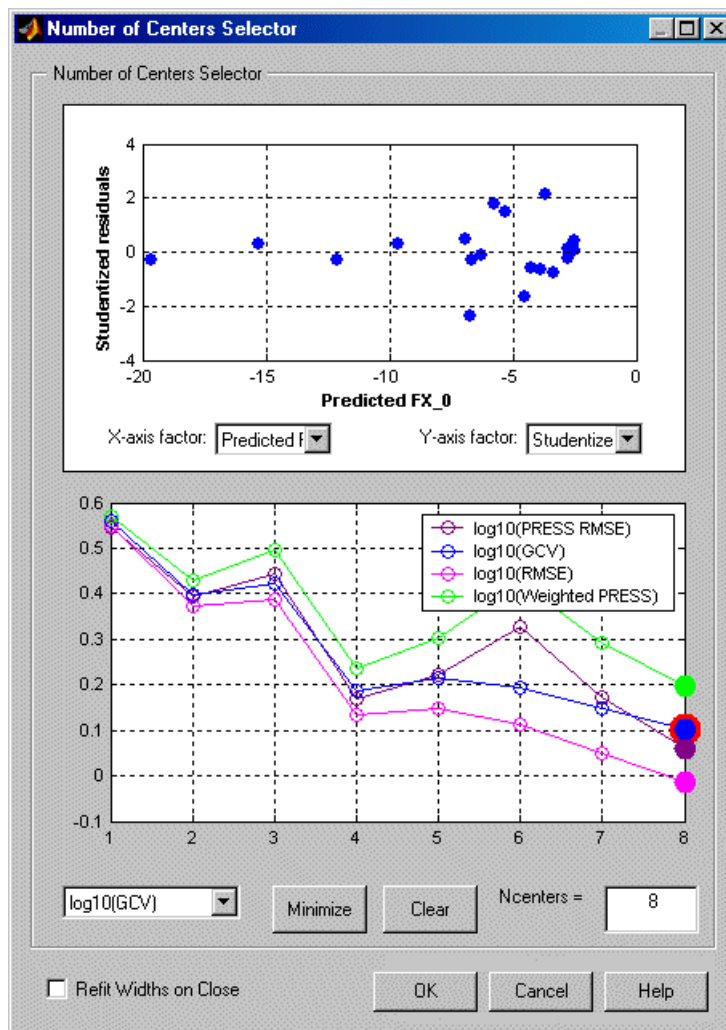

All four criteria in this typical example indicate the same minimum at eight centers.

If the graphs all decrease, as in the preceding example, this suggests that the maximum number of centers is too small, and the number of centers should be increased.

Clicking the **Minimize** button selects the number of centers that minimizes the criterion selected in the drop-down menu on the left. It is good if this value also minimizes all the other criteria. The **Clear** button returns to the previous selection.

Note that reducing the number of centers using Prune only refits the linear parameters (RBF weights). The nonlinear parameters (center locations, width, and lambda) are not adjusted. You can perform a cheap width refit on exiting the dialog box by selecting the **Refit widths on close** check box. If a network has been pruned significantly, you should use the Update Model Fit toolbar button. This performs a full refit of all the parameters.

Statistics

- “Overview of Radial Basis Function Statistics” on page 7-27
- “GCV Criterion” on page 7-28
- “GCV for Ridge Regression” on page 7-29
- “GCV for Rols” on page 7-30
- “References” on page 7-31

Overview of Radial Basis Function Statistics

Let A be the matrix such that the weights are given by $\beta = A^{-1}X'y$ where X is the regression matrix. The form of A varies depending on the basic fit algorithm employed.

In the case of ordinary least squares, we have $A = X'X$.

For ridge regression (with regularization parameter λ), A is given by $A = X'X + \lambda I$

Next is the Rols algorithm. During the Rols algorithm X is decomposed using the Gram-Schmidt algorithm to give $X = WB$, where W has orthogonal columns and B is upper triangular. The corresponding matrix A for Rols is then $A = X'X + \lambda B'B$.

The matrix $H := XA^{-1}X'$ is called the hat matrix, and the leverage of the i th data point h_i is given by the i th diagonal element of H . All the statistics derived from the hat matrix, for example, PRESS, studentized residuals, confidence intervals, and Cook's distance, are computed using the hat matrix appropriate to the particular fit algorithm.

Similarly PEV, given in the "Toolbox Terms and Statistics Definitions" on page 6-114 as

$$PEV(x) = \text{var}y(\hat{y}) = x(X^T X)^{-1} x^T \text{MSE}$$

becomes

$$PEV(x) = \text{var}y(\hat{y}) = xA^{-1} x^T \text{MSE}$$

PEV is computed using the form of A appropriate to the particular fit algorithm (ordinary least squares, ridge or rols).

GCV Criterion

Generalized cross-validation (GCV) is a measure of the goodness of fit of a model to the data that is minimized when the residuals are small, but not so small that the network has overfitted the data. It is easy to compute, and networks with small GCV values should have good predictive capability. It is related to the PRESS statistic.

The definition of GCV is given by Orr (4, see "References" on page 7-31).

$$GCV = \frac{N(y'P^2 y)}{(\text{trace}(P))^2}$$

where y is the target vector, N is the number of observations, and P is the projection matrix, given by $I - XA^{-1}X^T$. See "Statistics" on page 7-27 for definition of A .

An important feature of using GCV as a criterion for determining the optimal network in our fit algorithms is the existence of update formulas for the regularization parameter λ . These update formulas are obtained by

differentiating GCV with respect to λ and setting the result to zero. That is, they are based on gradient-descent.

This gives the general equation (from Orr, 6, “References” on page 7-31)

$$y'P \frac{\partial(Py)}{\partial \lambda} \text{trace}(P) = (y'P^2 y) \frac{\partial(\text{trace}(P))}{\partial \lambda}$$

We now specialize these formulas to the case of ridge regression and to the Rols algorithm.

GCV for Ridge Regression

It is shown in Orr (4), and stated in Orr (5, see “References” on page 7-31) that for the case of ridge regression GCV can be written as

$$GCV = \frac{N(e'e)}{(N-p)^2}$$

where P is the “effective number of parameters” that is given by

$$p = \text{NumTerms} - \lambda \text{trace}(A^{-1})$$

where NumTerms is the number of terms included in the model.

For RBFs, 'p' is the effective number of parameters, that is, the number of terms minus an adjustment to take into account the smoothing effect of lambda in the fitting algorithm. When lambda = 0, the effective number of parameters is the same as the number of terms.

$$\lambda = \frac{\eta}{N-p} \frac{(e'e)}{(\beta'A^{-1}\beta)^2}$$

The formula for updating λ is given by $\eta = \text{tr}(A^{-1} - \lambda A^{-2})$ where

In practice, the preceding formulas are not used explicitly in Orr (5, see “References” on page 7-31). Instead a singular value decomposition of X is made, and the formulas are rewritten in terms of the eigenvalues and eigenvectors of the matrix XX' . This avoids taking the inverse of the matrix

A, and it can be used to cheaply compute GCV for many values of λ . See “Statistics” on page 7-27 for definition of A.

GCV for Rols

In the case of Rols, the components for the formula

$$GCV = \frac{N(y'P^2y)}{(trace(P))^2}$$

are computed using the formulas given in Orr [6; see “References” on page 7-31]. Recall that the regression matrix is factored during the Rols algorithm into the product $X = WB$. Let w_j denote the j th column of W , then we have

$$y'P^2y = y'y - \sum_{j=1}^N \frac{(2\lambda + w_j'w_j)(y'w_j)^2}{(\lambda + w_j'w_j)^2}$$

and the “effective number of parameters” is given by

$$Trace(P) = NumTerms - \sum_{j=1}^N \frac{w_j'w_j}{(\lambda + w_j'w_j)}$$

This is equivalent to ‘p’ (the effective number of parameters) defined in “GCV for Ridge Regression” on page 7-29.

The reestimation formula for λ is given by

$$\lambda = \frac{\eta}{Trace(P)} \frac{y'P^2y}{(\beta'A^{-1}\beta)^2} \text{ where additionally}$$

$$\eta = \sum_{j=1}^N \frac{w_j'w_j}{(\lambda + w_j'w_j)^2} \text{ and } \beta'A^{-1}\beta = \sum_{j=1}^N \frac{(y'w_j)^2}{(\lambda + w_j'w_j)^3}$$

Note that these formulas for Rols do not require the explicit inversion of A. See “Statistics” on page 7-27 for definition of A.

References

- 1 Chen, S., Chng, E.S., Alkadhimi, Regularized Orthogonal Least Squares Algorithm for Constructing Radial Basis Function Networks, *Int J. Control*, 1996, Vol. 64, No. 5, pp. 829-837.
- 2 Hassoun, M., *Fundamentals of Artificial Neural Networks*, MIT, 1995.
- 3 Orr, M., *Introduction to Radial Basis Function Networks*, available from <http://www.anc.ed.ac.uk/rbf/rbf.html>.
- 4 Orr, M., *Optimizing the Widths of Radial Basis Functions*, available from <http://www.anc.ed.ac.uk/rbf/rbf.html>.
- 5 Orr, M., *Regularisation in the Selection of Radial Basis Function Centers*, available from <http://www.anc.ed.ac.uk/rbf/rbf.html>.
- 6 Wendland, H., *Piecewise Polynomials, Positive Definite and Compactly Supported Radial Basis Functions of Minimal Degree*, *Advances in Computational Mathematics* 4 (1995), pp. 389-396.

Hybrid Radial Basis Functions

- “Introducing Hybrid Radial Basis Functions” on page 7-31
- “Width Selection Algorithm: TrialWidths” on page 7-32
- “Lambda and Term Selection Algorithms: Interlace” on page 7-32
- “Lambda and Term Selection Algorithms: Two-Step” on page 7-33

Introducing Hybrid Radial Basis Functions

Hybrid RBFs combine a radial basis function model with more standard linear models such as polynomials or hybrid splines. The two parts are added together to form the overall model. This approach offers the ability to combine a priori knowledge, such as the expectation of quadratic behavior in one of the variables, with the nonparametric nature of RBFs.

The model setup GUI for hybrid RBFs has a top **Set Up** button, where you can set the fitting algorithm and options. The interface also has two tabs, one to specify the radial basis function part, and one for the linear model part.

Width Selection Algorithm: TrialWidths

This is the same algorithm as is used in ordinary RBFs, that is, a guided search for the best width parameter.

Lambda and Term Selection Algorithms: Interlace

This algorithm is a generalization of StepItRols for RBFs. The algorithm chooses radial basis functions and linear model terms in an interlaced way, rather than in two steps. At each step a forward search procedure is performed to select the radial basis function (with a center chosen from within the set of data points) or the linear model term (chosen from the ones specified in the linear model setup pane) that decreases the regularized error the most. This process continues until the maximum number of terms is chosen. The first few terms are added using the stored value of lambda, until the **Number of terms to add before updating** has been reached. Subsequently lambda is iterated after each center is added to improve GCV.

The fit options for this algorithm are as follows:

- **Maximum number of terms:** Maximum number of terms that will be chosen. The default is the number of data points.
- **Maximum number of centers:** Maximum number of terms that can be radial basis functions. The default is a quarter of the data points, or 25, whichever is smaller.

Note The maximum number of terms used is a combination of the maximum number of centers and the number of linear model terms. It is limited as follows:

Maximum number of terms used = Minimum(**Maximum number of terms**, **Maximum number of centers** + number of linear model terms)

As a result of this, the model may have more centers than specified in **Maximum number of centers**, but there will always be fewer terms than (**Maximum number of centers** + number of linear model terms). You can view the number of possible linear model terms on the Linear Part tab of the Global Model Setup dialog box (**Total number of terms**).

- **Percentage of data to be candidate centers:** Percentage of the data points that are available to be chosen as centers. The default is 100% when the number of data points is ≤ 200 .
- **Number of terms to add before updating:** How many terms to add before updating lambda begins.
- **Minimum change in $\log_{10}(\text{GCV})$:** Tolerance.
- **Maximum no. times $\log_{10}(\text{GCV})$ change is minimal:** Number of steps in a row that the change in $\log_{10}(\text{GCV})$ can be less than the tolerance before the algorithm terminates.

Lambda and Term Selection Algorithms: Two-Step

This algorithm starts by fitting the linear model specified in the linear model pane, and then fits a radial basis function network to the residual. You can specify the linear model terms to include in the usual way using the term selector. If desired, you can activate the stepwise options. In this case, after the linear model part is fitted, some of the terms are automatically added or removed before the RBF part is fitted. You can choose the algorithm and options that are used to fit the nonlinear parameters of the RBF by clicking the **Set Up** button in the RBF training options.

Tips for Modeling with Radial Basis Functions

- “Plan of Attack” on page 7-34
- “How Many RBFs to Use” on page 7-35
- “Width Selection Algorithms” on page 7-36
- “Which RBF to Use” on page 7-37
- “Lambda Selection Algorithms” on page 7-38
- “Center Selection Algorithms” on page 7-38
- “General Parameter Fine-Tuning” on page 7-39
- “Hybrid RBFs” on page 7-39
- “How to Find RBF Model Formula” on page 7-39

Plan of Attack

Determine which parameters have the most impact on the fit by following these steps:

- 1 Fit the default RBF. Remove any obvious outliers.
- 2 Get a rough idea of how many RBFs are going to be needed. If a center coincides with a data point, it is marked with a magenta asterisk on the Predicted/Observed plot. You can view the location of the centers in graphical and table format by using the **View Centers** toolbar button . If you remove an outlier which coincided with a center (marked with an asterisk), refit by clicking **Update Fit** in the toolbar.
- 3 Try with more than one kernel. You can alter the parameters in the fit by clicking the **Set Up** button in the Model Selection dialog box.
- 4 Decide on the main width selection algorithm. Try with both `TrialWidths` and `WidPerDim` algorithms.
- 5 Determine which types of kernel look most hopeful.
- 6 Narrow the corresponding width range to search over.
- 7 Decide on the center selection algorithm.
- 8 Decide on the lambda-selection algorithm.
- 9 Try changing the parameters in the algorithms.
- 10 If any points appear to be possible outliers, try fitting the model both with and without those points.

If at any stage you decide on a change that has a big impact (such as removal of an outlier), then you should repeat the previous steps to determine if this would affect the path you have chosen.

See “Fitting Routines” on page 7-11 for details on all the fit parameters.

The Model Browser has a quick option for comparing all the different RBF kernels and trying a variety of numbers of centers.

- 1 After fitting the default RBF, select the RBF global model in the model tree.
- 2 Click the **Build Models** toolbar icon .
- 3 Select the **RBF** icon in the Build Models dialog box that appears and click **OK**.
- 4 The Model Building Options dialog box appears. You can specify a range of values for the maximum number of centers, and click **Model settings** to change any other model settings. The defaults used are the same as the parent RBF model type.
- 5 You can select the check box to **Build all kernels** to create models with the specified range of centers for each kernel type as a selection of child nodes of the current RBF model.

Note this can take a long time for local models as you will create alternative models with a range of centers for each kernel type for each response feature; once model building is started you can always click **Stop** to abort if the process is taking too long.

- 6 Click **Build** to create the specified models.

How Many RBFs to Use

- The main parameter that you must adjust in order to get a good fit with an RBF is the maximum number of centers. This is a parameter of the center selection algorithm, and is the maximum number of centers/RBFs that is chosen.
- Usually the maximum number of centers is the number of RBFs that are actually selected. However, sometimes fewer RBFs are chosen because the (regularized) error has fallen below the tolerance before the maximum was reached.
- You should use a number of RBFs that is significantly less than the number of data points, otherwise there are not enough degrees of freedom in the error to estimate the predictive quality of the model. That is, you cannot tell if the model is useful if you use too many RBFs. We would recommend an upper bound of 60% on the ratio of number of RBFs to number of data points. Having 80 centers when there are only 100 data points might

seem to give a good value of PRESS, but when it comes to validation, it can sometimes become clear that the data has been overfitted, and the predictive capability is not as good as PRESS would suggest.

- One strategy for choosing the number of RBFs is to fit more centers than you think is needed (say 70 out of 100), then use the Prune toolbar button  to reduce the number of centers in the model. After pruning the network, make a note of the reduced number of RBFs. Try fitting the model again with the maximum number of centers set to this reduced number. This recalculates the values of the nonlinear parameters (width and lambda) to be optimal for the reduced number of RBFs.
- One strategy for the use of Stepwise is to use it to minimize PRESS as a final fine-tuning for the network, once pruning has been done. Whereas Prune only allows the last RBF introduced to be removed, Stepwise allows any RBF to be taken out.
- Do not focus solely on PRESS as a measure of goodness of fit, especially at large ratios of RBFs to data points. Take $\log_{10}(\text{GCV})$ into account also.

Width Selection Algorithms

- Try both `TrialWidths` and `WidPerDim`. The second algorithm offers more flexibility, but is more computationally expensive. View the width values in each direction to see if there is significant difference, to see whether it is worth focusing effort on elliptical basis functions (use the View Model toolbar button ).

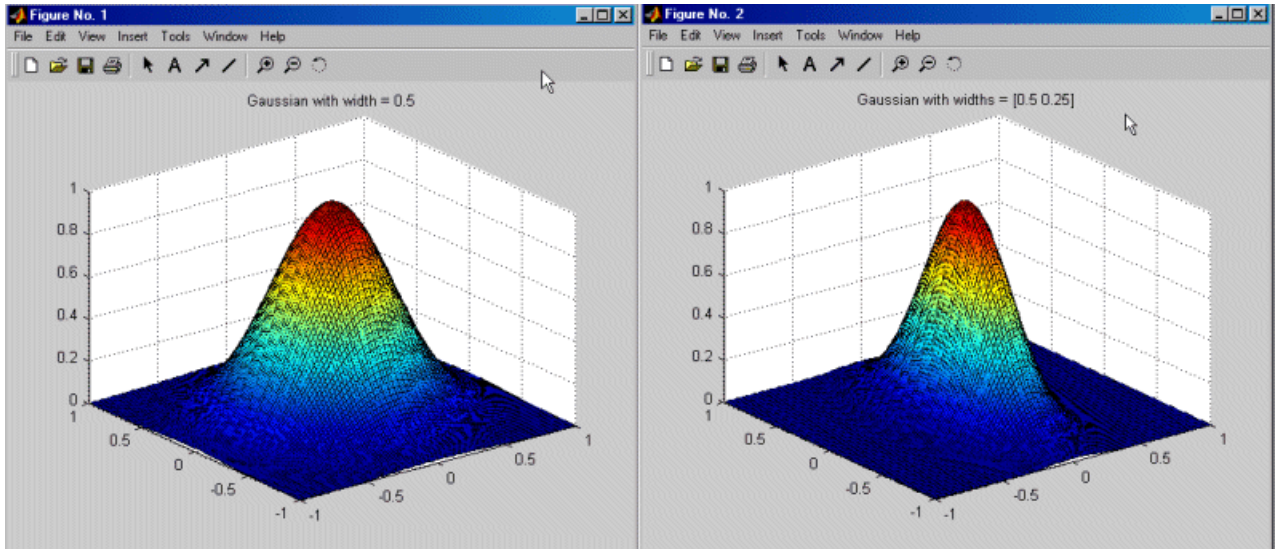

- If with a variety of basis functions the widths do not vary significantly between the dimensions, and the PRESS/GCV values are not significantly improved using `WidPerDim` over `TrialWidths`, then focus on `TrialWidths`, and just return to `WidPerDim` to fine-tune in the final stages.
- Turn the **Display** option on in `TrialWidths` to see the progress of the algorithm. Watch for alternative regions within the width range that have been prematurely neglected. The output $\log_{10}(\text{GCV})$ in the final zoom should be similar for each of the widths tried; that is, the output should be approximately flat. If this is not the case, try increasing the number of zooms.
- In `TrialWidths`, for each type of RBF, try to narrow the initial range of widths to search over. This might allow the number of zooms to be reduced.

Which RBF to Use

- It is hard to give rules of thumb on how to select the best RBF, as the best choice is highly data-dependent. The best guideline is to try all of them with both top-level algorithms (`TrialWidths` and `WidPerDim`) and with a sensible number of centers, compare the PRESS/GCV values, then focus on the ones that look most hopeful.

- If multiquadrics and thin-plate splines give poor results, it is worth trying them in combination with low-order polynomials as a hybrid spline. Try supplementing multiquadrics with a constant term and thin-plate splines with linear (order 1) terms. See “Hybrid Radial Basis Functions” on page 7-31.
- Watch out for conditioning problems with Gaussian kernels (say condition number $> 10^8$).
- Watch out for strange results with Wendland’s functions when the ratio of the number of parameters to the number of observations is high. When these functions have a very small width, each basis function only contributes to the fit at one data point. This is because its support only encompasses the one basis function that is its center. The residuals will be zero at each of the data points chosen as a center, and large at the other data points. This scenario can indicate good RMSE values, but the predictive quality of the network will be poor.

Lambda Selection Algorithms

Lambda is the regularization parameter.

- `IterateRols` updates the centers after each update of lambda. This makes it more computationally intensive, but potentially leads to a better combination of lambda and centers.
- `StepItRols` is sensitive to the setting of **Number of centers to add before updating**. Switch the **Display** option on to view how $\log_{10}(\text{GCV})$ reduces as the number of centers builds up.
- Examine the plots produced from the lambda selection algorithm, ignoring the warning “An excessive number of plots will be produced.” Would increasing the tolerance or the number of initial test values for lambda lead to a better choice of lambda?

Center Selection Algorithms

- On most problems, `Rols` seems to be the most effective.
- If less than the maximum number of centers are being chosen, and you want to force the selection of the maximum number, reduce the tolerance to epsilon (`eps`).

- CenterExchange is very expensive, and you should not use this on large problems. In this case, the other center selection algorithms that restrict the centers to be a subset of the data points might not offer sufficient flexibility.

General Parameter Fine-Tuning

- Try Stepwise after pruning, then update the model fit with the new maximum number of centers set to the number of terms left after Stepwise.
- Update the model fit after removal of outliers; use the toolbar button.

Hybrid RBFs

- Go to the linear part pane and specify the polynomial or spline terms that you expect to see in the model.

Fitting too many non-RBF terms is made evident by a large value of lambda, indicating that the underlying trends are being taken care of by the linear part. In this case, you should reset the starting value of lambda (to say 0.001) before the next fit.

How to Find RBF Model Formula

With any model you can use the **View Model** toolbar button or **View > Model Definition** (or keyboard shortcut **CTRL+V**) to see the details of the current model. The Model Viewer dialog box appears. Here for any RBF model you can see the kernel type, number of centers, width and regularization parameter.

However to specify the formula of an RBF model completely, you also need to give the locations of the centers, and the height of each basis function. The center location information is available in the “View Centers” dialog box and the coefficients can be found in the “Stepwise” window. Note these values are all in coded units.

B

Box-Cox transformation 6-100

C

constraints manager 3-51

correlation models 5-44

covariance modeling 5-42

D

data 4-2

import wizard 4-19

loading from file 4-18

loading from the Workspace 4-20

loading user-defined functions 4-52

merging 4-19 4-22

wizard 4-37

data editor 4-5

data selection window 4-24

datum models 5-88

definitions 6-114

design

adding points 3-42

classical 3-16

constraints 3-51

deleting points 3-47

fixing points 3-47

importing 3-50

optimal 3-31

saving 3-50

sorting points 3-47

space filling 3-19

styles 3-4

tree 3-7

Design Editor 3-2

display options 3-9

displays 3-5

Menus 3-9

designing experiments 2-19

F

filter editor 4-28

G

global level 6-26

global models

free knot spline 5-82

hybrid RBF 5-78

interpolating RBF 5-79

linear

hybrid spline 5-68

multiple 5-80

polynomial 5-67

neural network 5-84

radial basis functions 5-73

transient 5-86

user-defined 5-86

global regression 6-113

H

hierarchical models 6-104

I

inputs

setting up 2-17

interaction 5-71

L

linear model statistics 6-30

local level 6-2

local model setup 5-4

local models

average fit 5-20

B-spline 5-11

growth models 5-12

linear 5-19

multiple models 5-22

- polynomial 5-5
- polynomial spline 5-6
- transient 5-35
- truncated power series 5-9
- user-defined 5-26

M

- MLE 6-75
- model building process overview 6-94
- model evaluation 6-82
- model selection 6-42
- model setup
 - global 5-66
 - local 5-4
 - response 5-87
- model tree 2-26

N

- neural network 5-84
- new test plan templates 2-12

O

- one-stage model
 - instant setup 1-3

P

- point-by-point model
 - instant setup 1-7
- Prediction Error Variance (PEV) viewer 3-63
- project level 2-2

R

- radial basis functions

- fitting routines 7-11
- guide 7-2
- hybrid RBFs 7-31
- prune functionality 7-25
- statistics 7-27
- tips for modeling 7-33

- response level 6-79

S

- stepwise 5-72
- stepwise regression techniques 6-87

T

- test groupings 4-34
- test plan level 2-15
- test plans 2-11
- transforms 5-44
- two-stage model
 - instant setup 1-5

V

- variable editor 4-24
- view
 - cross-section 6-60
 - likelihood 6-55
 - predicted/observed 6-49
 - residuals 6-59
 - response surface 6-51
 - RMSE 6-57
 - tests 6-46
- viewing designs 2-20